

Jansen-Economy 60 RS (Smoke)

Rauchschtütztüren nach DIN 18095 (EN 1634-3) aus Stahl

Jansen-Economy 60 RS (Smoke)

Portes coupe-fumée selon DIN 18095 (EN 1634-3) en acier

Jansen-Economy 60 RS (Smoke)

Smoke control doors according to DIN 18095 (EN 1634-3) in steel

Systemübersicht

Merkmale
Zulassungen
Systemausführungen
Typenübersicht

Sommaire du système

Caractéristiques
Homologations
Exécutions de système
Sommaire des types

Summary of system

Characteristics
Authorisations
System versions
Summary of types

2

Profilsortiment

Assortiment de profilé

Range of profiles

12

Beispiele

Schnittpunkte
Konstruktionsdetails
Anschlüsse am Bau

Exemples

Coupes de détails
Détails de construction
Raccords au mur

Examples

Section details
Construction details
Attachment to structure

16

Leistungseigenschaften

Caractéristiques de performance

Performance characteristics

28

Alle Ausführungen dieser Dokumentation haben wir sorgfältig und nach bestem Wissen zusammengestellt. Wir können aber keine Verantwortung für die Benutzung der vermittelten Vorschläge und Daten übernehmen. Wir behalten uns technische Änderungen ohne Vorankündigung vor.
Aktuelle Version auf www.jansen.com

Nous avons apporté le plus grand soin à l'élaboration de cette documentation. Cependant, nous déclinons toute responsabilité pour l'utilisation faite de nos propositions et de nos données.
Nous nous réservons le droit de procéder à des modifications techniques sans préavis.
Version actuelle sur www.jansen.com

All the information contained in this documentation is given to the best of our knowledge and ability. However, we decline all responsibility for the use made of these suggestions and data.
We reserve the right to effect technical modifications without prior warning.
Current version available at www.jansen.com







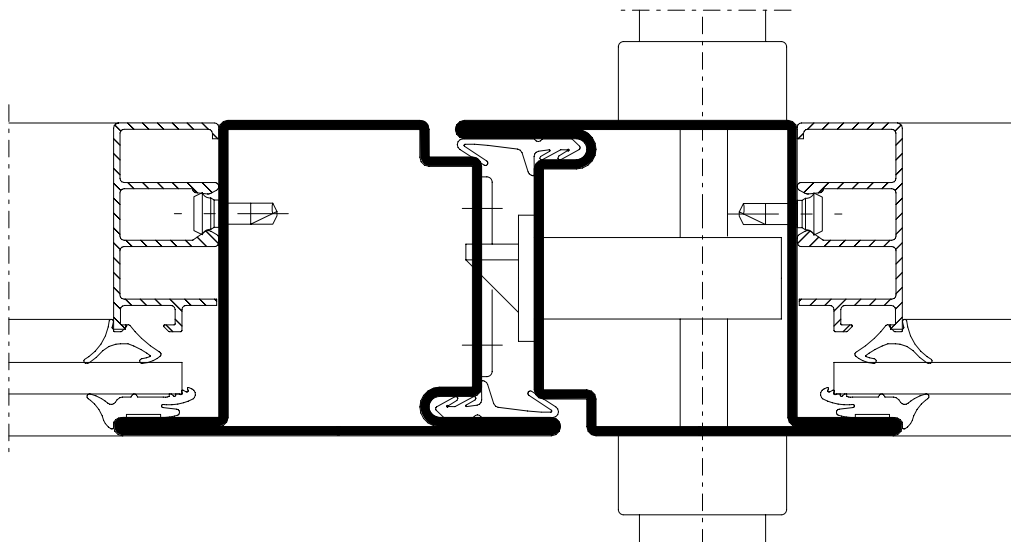

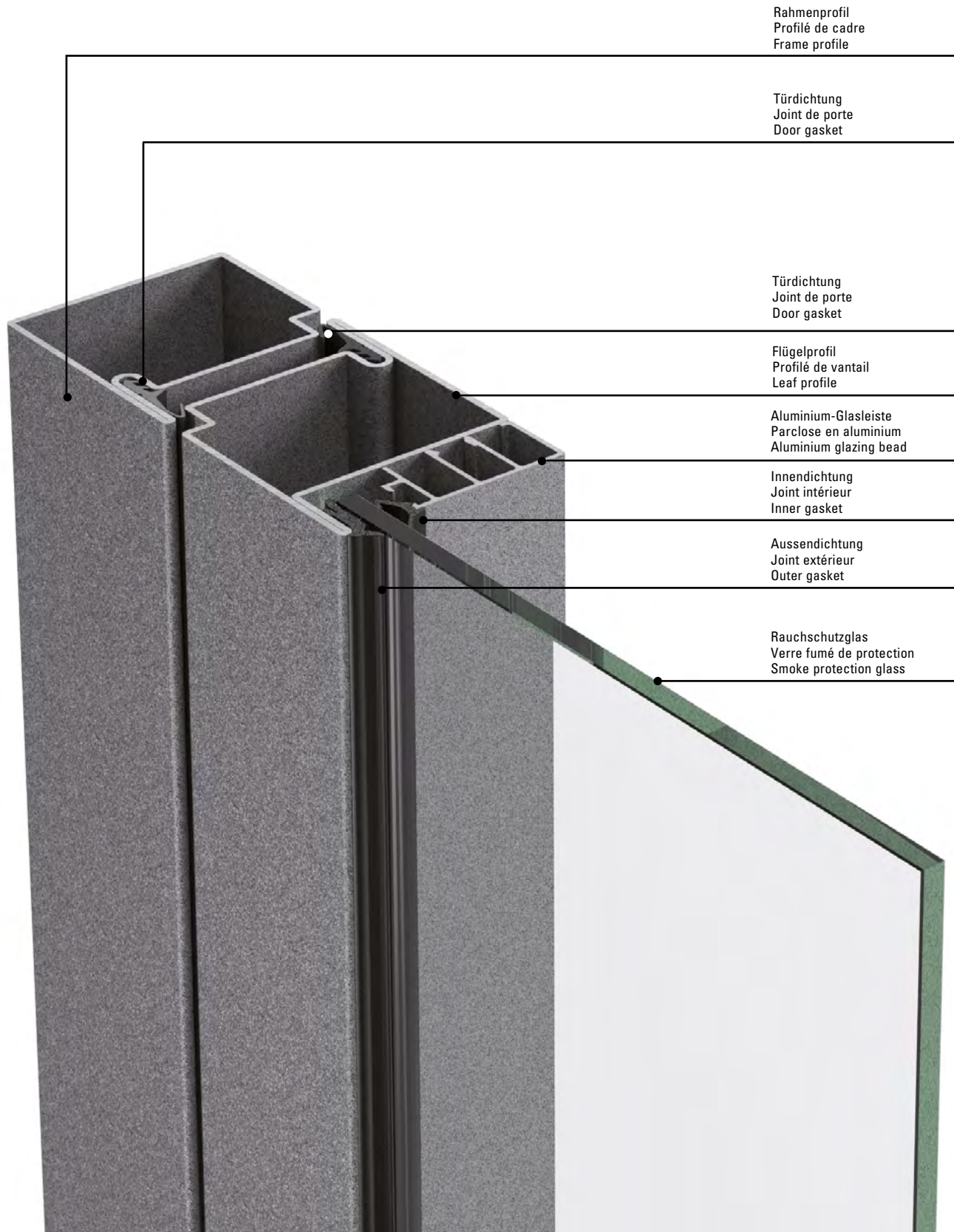

Merkmale
Caractéristiques
Characteristics





Jansen-Economy 60 RS DIN 18095
Jansen-Economy 60 RS DIN 18095
Jansen-Economy 60 RS DIN 18095

- Stahlssystem für Türen und Festverglasungen
- Bautiefe 60 mm, innen und aussen flächenbündig
- Schmale Ansichtsbreiten: Rahmen und Flügel ab 105 mm Stulppartie 150 mm
- Ein- und zweiflüglige Türen, nach innen und aussen öffnend, mit oder ohne Seitenteile und Oberlichter sowie Trennwände
- Türflügel bis 1750 x 3750 mm (BxH), landesspezifische Zulassung beachten
- Füllelementstärke von 5 bis 26 mm, Glaseinbau mittels Trocken- oder Nassverglasung
- Stahlprofile blank oder bandverzinkt
- Grosses Sortiment an systemgeprüften Türbeschlägen
- Barrierefreie Schwellenausbildungen
- Geeignet für Pulver- und Nasslackbeschichtungen
- Rauchschutztüre gemäss DIN 18095, EN 1634-3 und EN 16034, Systemprüfungen nach Produktnorm EN 14351-1
- Erscheinungsbild deckungsgleich mit anderen Jansen Brandschutzsystemen Jansen-Economy 50, Janisol 2 und Janisol C4
- Système en acier pour portes et vitrages fixes
- Profondeur de montage 60 mm, montage à fleur à l'intérieur et à l'extérieur
- Fines largeurs de face: Cadre et vantaux à partir de 105 mm Partie tête 150 mm
- Portes à un et deux vantaux, ouverture vers l'intérieur et vers l'extérieur, combinables avec parties latérales, impostes et vitrage fixe
- Vantaux de porte jusqu'à 1750 x 3750 mm (LaxH), il convient de respecter les prescriptions et règlements des divers pays concernés
- Élément de remplissage de 5 à 26 mm d'épaisseur, Montage du vitrage à sec ou à silicone
- Profilés en acier brut ou galvanisé en continu
- Grand assortiment de ferrures de porte homologuées
- Formes de seuil sans barrière
- Convient aux revêtements par poudre ou peinture liquide
- Porte coupe-fumée selon DIN 18095, EN 1634-3 et EN 16034, contrôles des systèmes selon la norme produit EN 14351-1
- Apparence égale comme les autres systèmes coupe-feu de Jansen (Jansen-Economy 50, Janisol 2 et Janisol C4)
- Steel system for doors and fixed glazing
- 60 mm basic depth, flush-fitted on the inside and outside
- Narrow face widths: Frame and leaf from 105 mm Meeting stile assembly 150 mm
- Single and double-leaf doors, inward and outward-opening, can be combined with side-lights, toplight or fixed glazing
- Door leaf up to 1750 x 3750 mm (WxH), the regulations and bye-laws in force in the particular country must be respected
- Infill unit thickness of 5 to 26 mm, Glazing installed by means of dry or wet glazing
- Raw finish or strip galvanised steel profiles
- Large range of system-tested door fittings
- Easy-access thresholds
- Suitable for powder and wet paint coating
- Smoke-proof door according to DIN 18095, EN 1634-3 and EN 16034, system tests in accordance with EN 14351-1
- Same appearance as the other Jansen fire-resistant systems Jansen-Economy 50, Janisol 2 and Janisol C4





Norm	Eigenschaft Caractéristique Characteristic	Klassifizierung/Wert Classification / Valeur Classification / Value										
		npd	1 (400)	2 (800)	3 (1200)	4 (1600)	5 (2000)	Exxx (>2000)				
 EN 12210	Widerstandsfähigkeit bei Windlast Résistance à la pression du vent Resistance to wind load	npd	1 (400)	2 (800)	3 (1200)	4 (1600)	5 (2000)	Exxx (>2000)				
 EN 12208	Schlagregendichtheit Étanchéité à la pluie battante Watertightness	npd	1A (0)	2A (50)	3A (100)	4A (150)	5A (200)	6A (250)	7A (300)	8A (450)	9A (600)	Exxx (>750)
 EN ISO 10140	Schalldämmung R_w (C, C_{tr}) (dB) Isolation phonique R_w (C, C_{tr}) (dB) Sound insulation R_w (C, C_{tr}) (dB)	npd	bis R_w 44 dB (-2; -5) jusqu'à R_w 44 dB (-2; -5) up to R_w 44 dB (-2; -5)									
 EN ISO 10077-2	Wärmedurchgangskoeffizient U_f (W/(m ² ·K)) Transmission thermique U_f (W/(m ² ·K)) Thermal production U_f (W/(m ² ·K))	npd	ab 5.65 W/m ² K à partir de 5.65 W/m ² K from 5.65 W/m ² K									
 EN 12207	Luftdurchlässigkeit Perméabilité à l'air Air permeability	npd	1 (150)		2 (300)		3 (600)		4 (600)			
 EN 1192	Klassifizierung der Festigkeitsanforderungen Classification des exigences de résistance méc. Classification of strength requirements	npd	1		2		3		4			
 EN 1627	Einbruchhemmung Anti-effraction Burglar resistance	npd	1		2		3		4		5	6
 EN 1522	Durchschusshemmung Résistance aux balles Bullet proofing	npd	FB1	FB2	FB3	FB4	FB5	FB6	FB7	FSG		
 EN 1191 EN 1603	Dauerfunktionsprüfung Durabilité mécanique Mechanical durability	D	1 5'000	2 10'000	3 20'000	4 50'000	5 100'000	6 200'000	7 500'000	8 1'000'000		
 EN 179 EN 1125	Fähigkeit zur Freigabe Capacité au déclenchement Ability to release		Anforderung erfüllt Exigence remplie Requirement fulfilled									

Norm	Eigenschaft Caractéristique Characteristic	Klassifizierung/Wert Classification / Valeur Classification / Value			
 EN 12217	Bedienkräfte Forces de manœuvre Operating forces	npd	0	1	2
 EN 1634-3 DIN 18095	Rauchschutz Etanchéité à la fumée Smoke control	S _a / S ₂₀₀			
 EN 16034 EN 13501-2	Selbstschliessung Fermeture automatique Self-closing	C			
 EN 16034	Dauerhaftigkeit der Selbstschliessung gegenüber Alterung (Korrosion) Endurance de la fermeture automatique contre le vieillissement (corrosion) Durability of self-closing against ageing (corrosion)	erzielt atteinte achieved			



Fluchttürsysteme

- Fluchttürsysteme geeignet für Notausgänge und Paniktüren
- Fluchttürnorm EN 179 für Notausgangsverschlüsse erfüllt
- Fluchttürnorm EN 1125 für Panikverschlüsse erfüllt

Systèmes de porte de secours

- Systèmes de porte de secours pour issues de secours et portes panique
- Norme relative aux portes de secours EN 179, remplie pour les fermetures d'issue de secours
- Norme relative aux portes de secours EN 1125, remplie pour les fermetures panique

Emergency exit systems

- Emergency exit systems suitable for emergency exits and panic doors
- Emergency exit standard EN 179 for emergency exit devices fulfilled
- Emergency exit standard EN 1125 for panic exit devices fulfilled

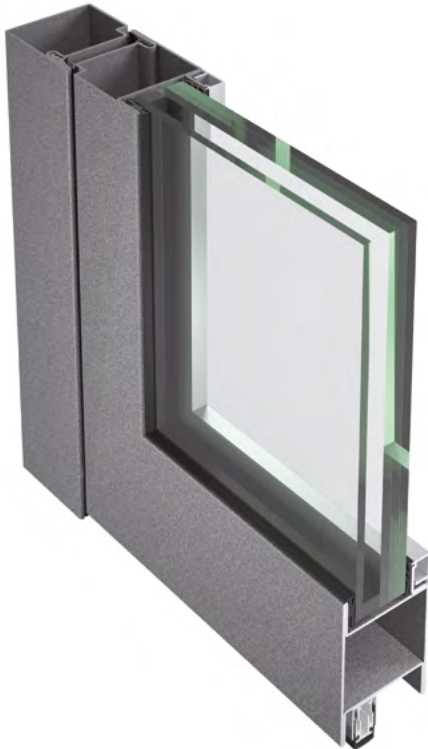

Einbruchhemmende Jansen-Economy 60 RS Türen

- Türgrößen bis 1475 x 3000 mm
- Ein- und zweiflüglige Türen, nach innen und aussen öffnend
- Normal- und Panikfunktion bis RC3
- Geprüft nach EN 1627

Portes anti-effraction Jansen-Economy 60 RS

- Dimensions de porte jusqu'à 1475 x 3000 mm
- Portes à un/deux vantaux ouvrant vers l'intérieur et l'extérieur
- Fonction normale et fonction panique jusqu'à RC3
- Contrôlé selon la norme EN 1627

Burglar-resistant Jansen Economy 60 RS doors

- Door sizes up to 1475 x 3000 mm
- Single and double-leaf doors, inward and outward-opening
- Standard and panic function up to RC3
- Tested in accordance with EN 1627



Verblechte Jansen-Economy 60 RS Türen

- Für ein- und zweiflügelige Brandschutztüren mit oder ohne Seitenteile resp. Oberlichter
- Flächenbündig verblechte Türen
- Bleche können an den Rahmen geschweisst oder geklebt werden
- Mit oder ohne Glasausschnitte möglich

Portes tôlées Jansen-Economy 60 RS

- Pour des portes coupe-feu à un/deux vantaux avec ou sans pièces latérales ou impostes
- Portes tôlées à fleur
- Les tôles peuvent être soudées ou collées sur le cadre
- Possibles avec ou sans panneaux de verre

Jansen Economy 60 RS sheet metal doors

- For single and double-leaf fire doors with or without sidelights or toplights
- Flush-fitted sheet metal doors
- Sheet metal can be welded or bonded to the frame
- Possible with or without glass vision panels

Jansen Docu Center

Die Plattform zum effizienten Arbeiten mit Jansen Dokumentationen. Im Jansen Docu Center stehen alle Produktinformationen jederzeit digital in der aktuellsten Version zur Verfügung: von Architekten-Informationen über Bestell- und Fertigungskatalogen bis hin zu Anleitungen und Prospekten sowie Videos.

Die Inhalte können einfach und schnell aufgerufen werden. Ein für den Anwender komfortables papierloses Arbeiten, das zahlreiche Vorteile bietet.

Download CAD Daten

DXF

DWG

Sie können die Zeichnungen in den Formaten DXF und/oder DWG herunterladen. Klicken Sie auf das entsprechende Icon und der Download erfolgt.

Die Hinweise «Artikelbibliothek/Türbeschläge/Fensterbeschläge» bedeuten, dass Sie mit einem Klick die gesamte Artikelbibliothek des entsprechenden Systems herunterladen (Profile, Beschläge, Glasleisten, Zubehör etc.).

Info und Beratung

Gerne beraten wir Sie persönlich und stehen Ihnen bei Fragen zur Verfügung. Bitte schreiben Sie uns Ihre Anliegen an: info@jansen.com

Jansen Docu Center

La plate-forme pour travailler efficacement avec les documentations Jansen. Le Jansen Docu Center met à votre disposition les informations sur les produits, en format numérique et dans une version actualisée: des catalogues de commande et de fabrication aux instructions et prospectus, en passant par les informations destinées aux architectes et vidéos.

Les contenus sont facilement et rapidement accessibles. Une manière de travailler confortable et offrant de nombreux avantages.

Télécharger fichiers DAO

DXF

DWG

Vous pouvez télécharger les dessins aux formats DXF et/ou DWG. Cliquez sur l'icône correspondante et le téléchargement s'effectuera.

Les indications «Bibliothèque des articles/Ferures de porte/Ferrures de fenêtres» signifie que vous téléchargez la totalité de la bibliothèque des articles du système donné (profilés, ferrures, parcloles, accessoires etc.).

Info et conseils

Nous vous conseillons volontiers individuellement et sommes à votre disposition si vous avez des questions à poser. Veuillez nous envoyer votre requête à: info@jansen.com

Jansen Docu Center

The platform for working efficiently with Jansen documentation. The latest version of all the product information is available digitally at any time in the Jansen Docu Center – from order and fabrication manuals to architect information, instructions and brochures and videos.

The content can be retrieved quickly and easily. The user can work conveniently without paper, which has numerous benefits.

Download CAD files

DXF

DWG

You can download the drawings in DXF and/or DWG format. Click on the relevant icon to begin the download.

The items «Article library/Door fittings/Window fittings» means that you download the entire article library for the corresponding system with one click (profiles, fittings, glazing beads, accessories etc.).

Information and advice

We would be delighted to provide you with advice in person and are available to answer any questions you may have. Please write to us with your queries at: info@jansen.com

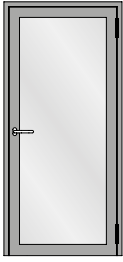

Einflügelige Türe
Porte à un vantail
Single leaf door

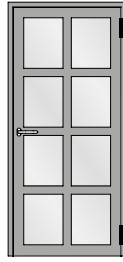

Einflügelige Türe mit Riegel
Porte à un vantail avec traverse
Single leaf door with transom

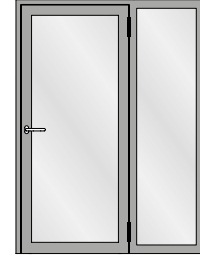

Einflügelige Türe mit festem Seitenteil
Porte à un vantail avec partie latérale fixe
Single leaf door with fixed side light

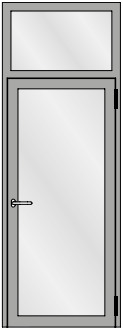

Einflügelige Türe mit festem Oberlicht
Porte à un vantail avec imposte fixe
Single leaf door with fixed top light

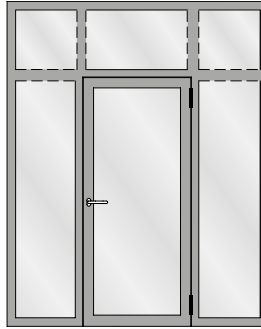

Einflügelige Türe mit zwei festen Seitenteilen
und festem Oberlicht
Porte à un vantail avec deux parties latérale fixe
et imposte fixe
Single leaf door with two fixed side light and
fixed top light

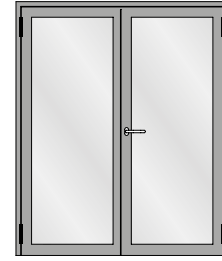

Zweiflügelige Türe
Porte à deux vantaux
Double leaf door

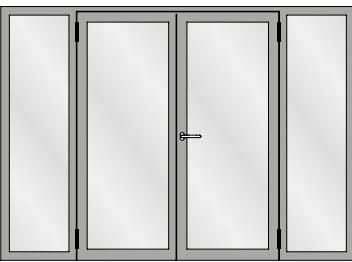

Zweiflügelige Türe mit zwei festen Seitenteilen
Porte à deux vantaux avec deux parties
latérales fixes
Double leaf door with two fixed side lights

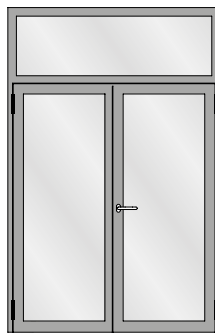

Zweiflügelige Türe mit festem Oberlicht
Porte à deux vantaux avec imposte fixe
Double leaf door with fixed top light

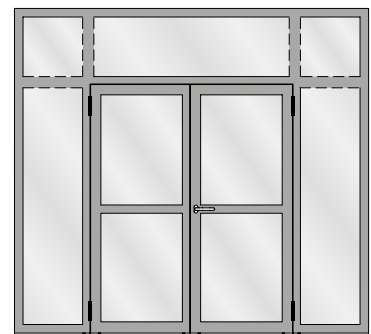

Zweiflügelige Türe mit zwei festen Seitenteilen
und festen Oberlichtern
Porte à deux vantaux avec deux parties latérales
fixes et impostes fixes
Double leaf door with two fixed side lights and
fixed top lights

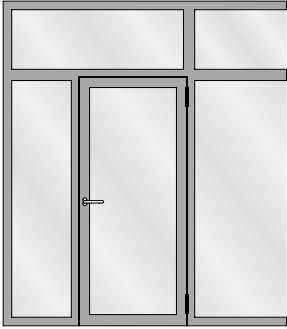

Festverglasung mit einflügeliger Türe
Vitrage fixe avec porte à un vantail
Fixed glazing with single leaf door

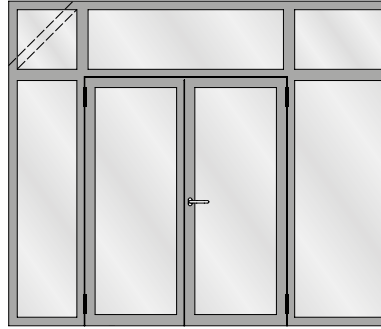

Festverglasung mit zweiflügeliger Türe
Vitrage fixe avec porte à deux vantaux
Fixed glazing with double leaf door



Festverglasung
Vitrage fixe
Fixed glazing

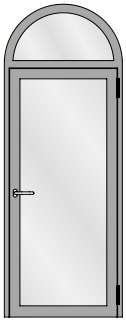

Einflügelige Türe mit Rundbogen-Oberlicht
Porte à un vantail avec imposte demi-ronde
Single leaf door with round arched top light

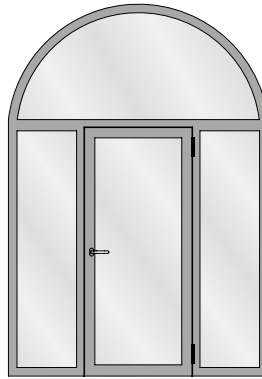

Einflügelige Türe mit zwei festen Seitenteilen
und Rundbogen-Oberlicht
Porte à un vantail avec deux parties latérales
fixes et imposte demi-ronde
Single leaf door with two fixed side lights and
round arched top light

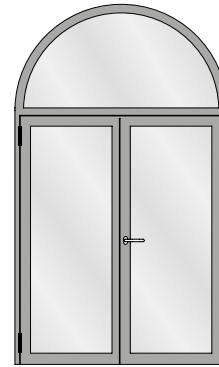

Zweiflügelige Türe mit Rundbogen-Oberlicht
Porte à deux vantaux avec imposte demi-ronde
Double leaf door with round arched top light

**Für Festverglasungen gelten
nationale Zulassungen.**

**Les homologations nationales
s'appliquent aux vitrages fixes.**

**National approvals apply to fixed
glazing.**

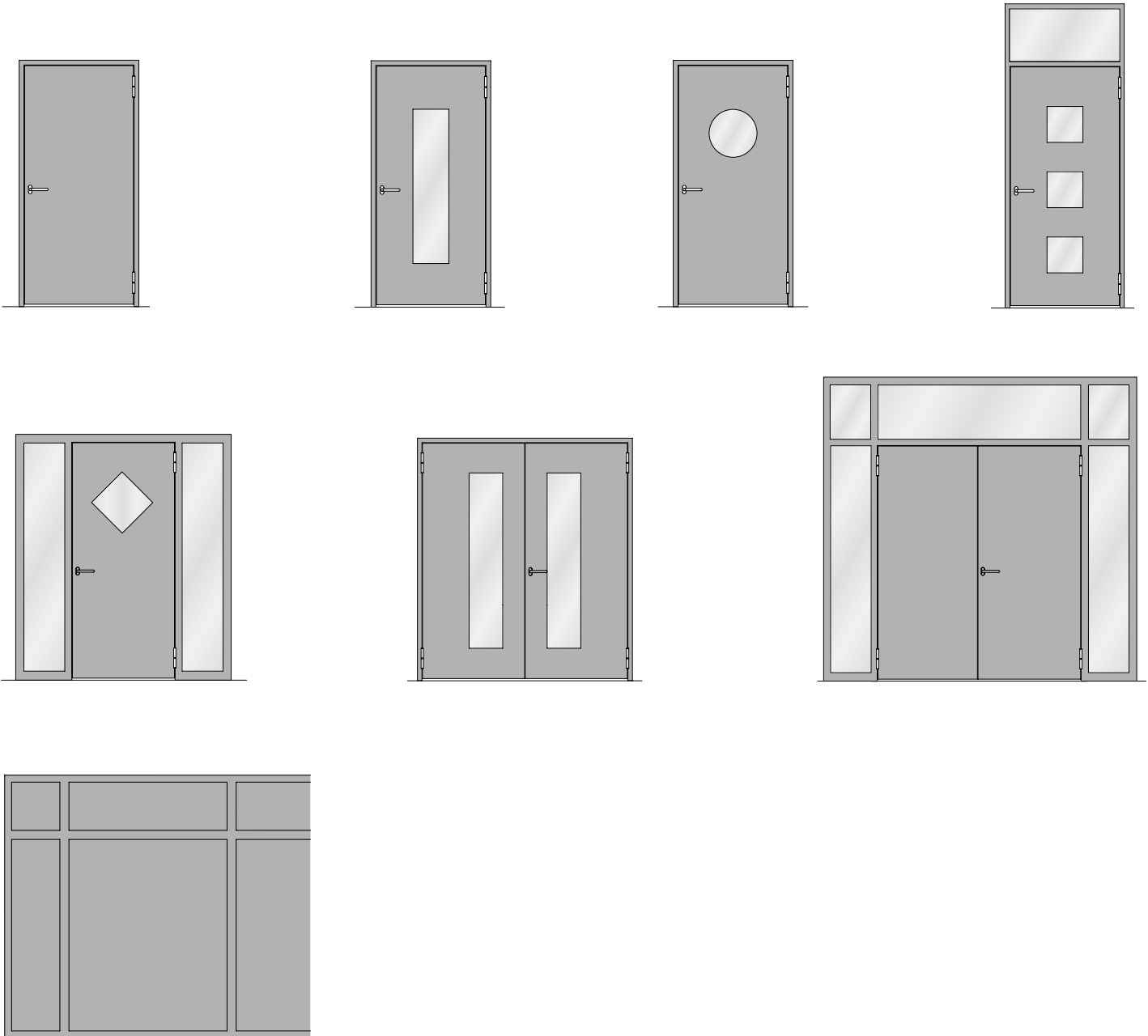

Für Festverglasungen gelten nationale Zulassungen.

Les homologations nationales s'appliquent aux vitrages fixes.

National approvals apply to fixed glazing.

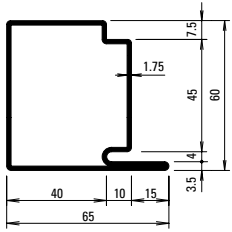

30.019
30.019 Z

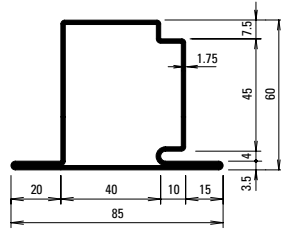

30.119
30.119 Z

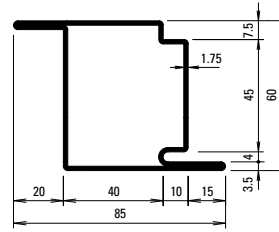

30.419
30.419 Z

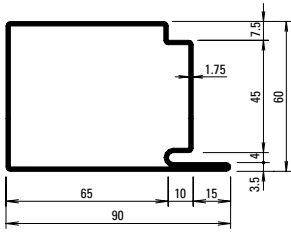

30.017
30.017 Z

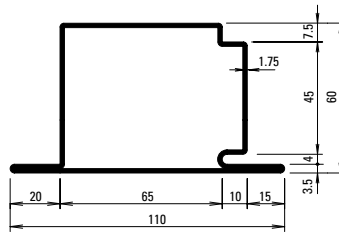

30.117
30.117 Z

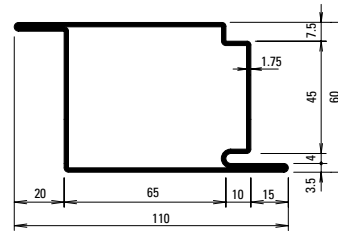

30.415

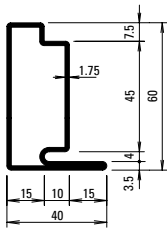

30.018
30.018 Z

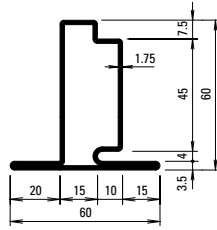

30.118
30.118 Z

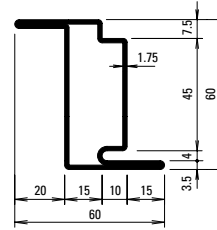

30.418
30.418 Z

Oberfläche/Werkstoff

Artikel-Nr.

ohne Zusatz = blank

mit Z = bandverzinkter Stahl

Surface/Matériau

No. d'article

sans supplément = brut

avec Z = bande d'acier zinguée

Surface/Material

Part no.

without addition = bright

with Z = strip galvanised steel

Profil-Nr.	G kg/m	F cm ²	I _x cm ⁴	W _x cm ³	I _y cm ⁴	W _y cm ³	U m ² /m
30.017	4,200	5,36	31,32	9,09	48,57	10,35	0,312
30.018	2,830	3,61	15,95	4,35	4,77	1,93	0,212
30.019	3,520	4,48	23,69	6,70	19,75	5,55	0,262
30.117	4,750	6,04	34,75	9,35	65,74	11,51	0,350
30.118	3,370	4,29	18,64	4,65	8,26	2,75	0,250
30.119	4,050	5,16	26,80	6,99	29,12	6,58	0,300

Profil-Nr.	G kg/m	F cm ²	I _x cm ⁴	W _x cm ³	I _y cm ⁴	W _y cm ³	U m ² /m
30.415	4,750	6,04	37,79	12,28	65,74	11,51	0,350
30.418	3,370	4,29	22,92	7,37	8,62	2,75	0,250
30.419	4,050	5,16	30,36	9,82	29,12	6,58	0,300

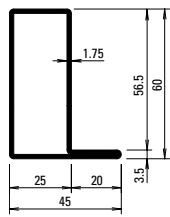

01.634
01.634 Z

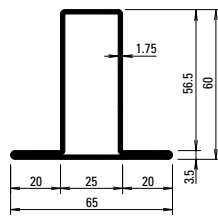

02.634
02.634 Z

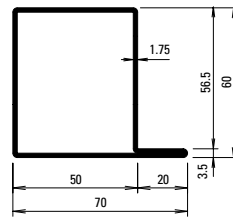

01.684
01.684 Z

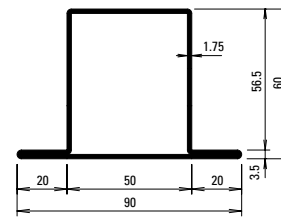

02.684
02.684 Z

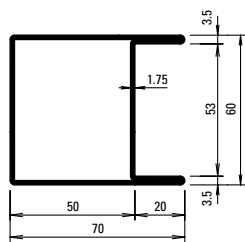

04.637
04.637 Z

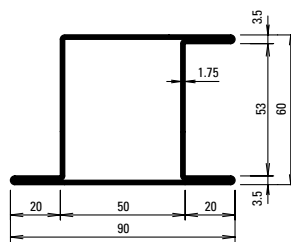

05.637
05.637 Z

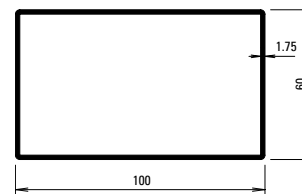

400.051
400.051 Z

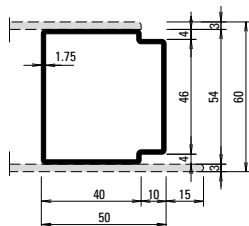

81.010
81.010 Z

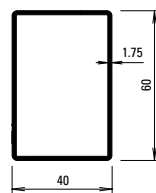

400.052
400.052 Z

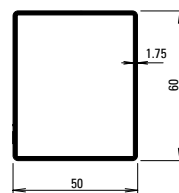

400.054
400.054 Z

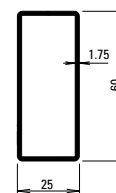

400.055
400.055 Z

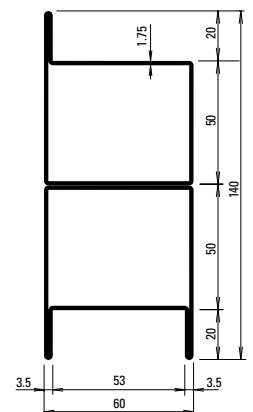

05.001

Profil-Nr.	G kg/m	F cm ²	I _x cm ⁴	W _x cm ³	I _y cm ⁴	W _y cm ³	U m ² /m
01.634	2,730	3,48	16,71	4,71	6,04	2,15	0,204
02.634	3,270	4,17	19,66	5,01	10,34	3,18	0,243
01.684	3,430	4,37	24,34	7,07	22,12	5,59	0,255
02.684	3,960	5,05	27,70	7,36	31,93	7,09	0,294
04.637	3,960	5,05	30,62	10,2	27,45	7,71	0,294
05.637	4,500	5,72	35,42	10,6	39,45	8,02	0,333
81.010	2,700	3,43	14,53	5,38	13,05	5,10	0,202
400.051	4,300	5,44	76,01	15,2	34,64	11,55	0,316
400.052	2,630	3,34	8,98	4,49	16,86	5,62	0,197
400.054	2,900	3,69	14,97	5,98	19,83	6,61	0,217
400.055	2,210	2,82	3,08	2,47	12,41	4,13	0,167

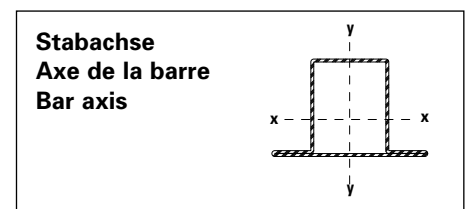

Artikelbibliothek
 Bibliothèque des articles
 Article library

DXF **DWG**

Bogentüren
Portes cintrées
Arched doors

Jansen-Economy 60 RS DIN 18095
 Jansen-Economy 60 RS DIN 18095
 Jansen-Economy 60 RS DIN 18095

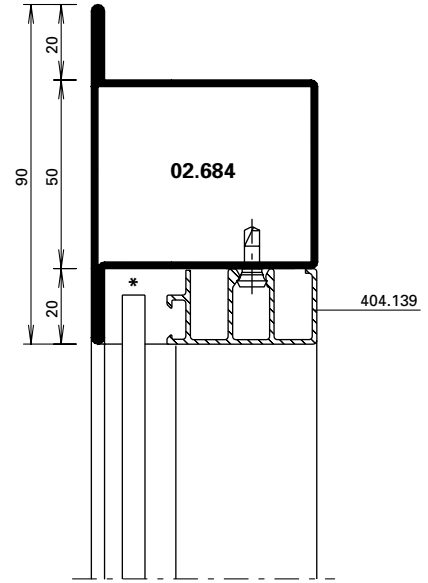
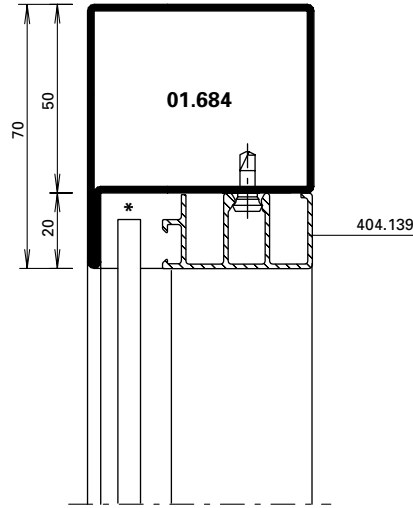
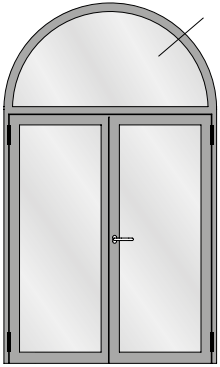

* Füllelemente mit rauchdichtem dauerelastischem Dichtstoff (z.B. 450.092) vollständig in den Glasfalzgrund einkleben.

* Coller entièrement les éléments de remplissage avec produit d'étanchéité à l'élasticité permanente (p.ex. 450.092) dans la feuillure en verre.

* Infill panels with smoke-tight, permanently flexible sealant (e.g. 450.092) fully glued into the glazing rebate platform.

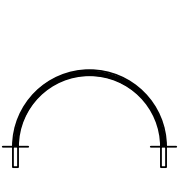

Halbrundbogen
 Arc semi-circulaire
 Semi-circular arch

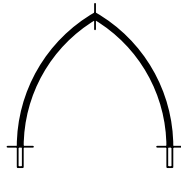

Spitzbogen
 Arc en ogive
 Gothic arch



Stichbogen
 Arc bombé
 Segmented arch



Korbbogen
 Anse de panier
 Oval arch

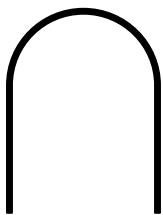

Halbrundbogen mit Schenkel
 Arc surhaussé prolongée
 Semi-circular arch with side extension

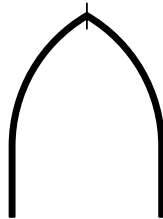

Spitzbogen mit Schenkel
 Arc en ogive prolongée
 Gothic arch with side extension

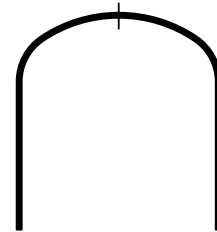



Korbbogen mit Schenkel
 Anse de panier prolongée
 Oval arch with side extension

Bogentüren
Portes cintrées
Arched doors

Jansen-Economy 60 RS DIN 18095
 Jansen-Economy 60 RS DIN 18095
 Jansen-Economy 60 RS DIN 18095

Profil Profilé Profile	Min. Radius Rayon min. Min. radius R	
------------------------------	---	--

	blank brut bright	verzinkt zingué galvanised
	mm	mm
01.634	350	
01.684	450	900

	350	600
02.634		
02.684		1050

	1550
04.637	

	1550
05.637	

	900	1100
400.052		
400.054		1000
400.055		700

Stahl-Glasleisten Parcloses en acier Steel glazing beads	Min. Radius Rayon min. Min. radius R
--	---

	500 mm
402.112 Z	
402.115 Z	500 mm
402.120 Z	600 mm
402.125 Z	750 mm
402.130 Z	1000 mm
402.135 Z	1500 mm

Stahl-Glasleisten Parcloses en acier Steel glazing beads	Min. Radius Rayon min. Min. radius R
--	---

	500 mm
62.507 Z	
62.508 Z	500 mm
62.509 Z	500 mm

Aluminium-Glasleisten Parcloses en aluminium Aluminium glazing beads	Min. Radius Rayon min. Min. radius R
--	---

	400 mm
404.112	
404.115	400 mm
404.120	400 mm
404.125	450 mm
404.130	500 mm
404.135	600 mm

	500 mm
405.115	
405.120	500 mm
405.125	800 mm
405.130	1000 mm
406.903	500 mm
406.905	500 mm
406.907	500 mm
406.909	600 mm

Die Radien-Angaben beziehen sich auf die langjährige Erfahrung und Fertigung im Hause Jansen.

Les rayons indiqués se fondent sur la longue expérience et la fabrication au sein de la maison Jansen.

The radii specifications are based on the many years of experience Jansen has in fabrication.

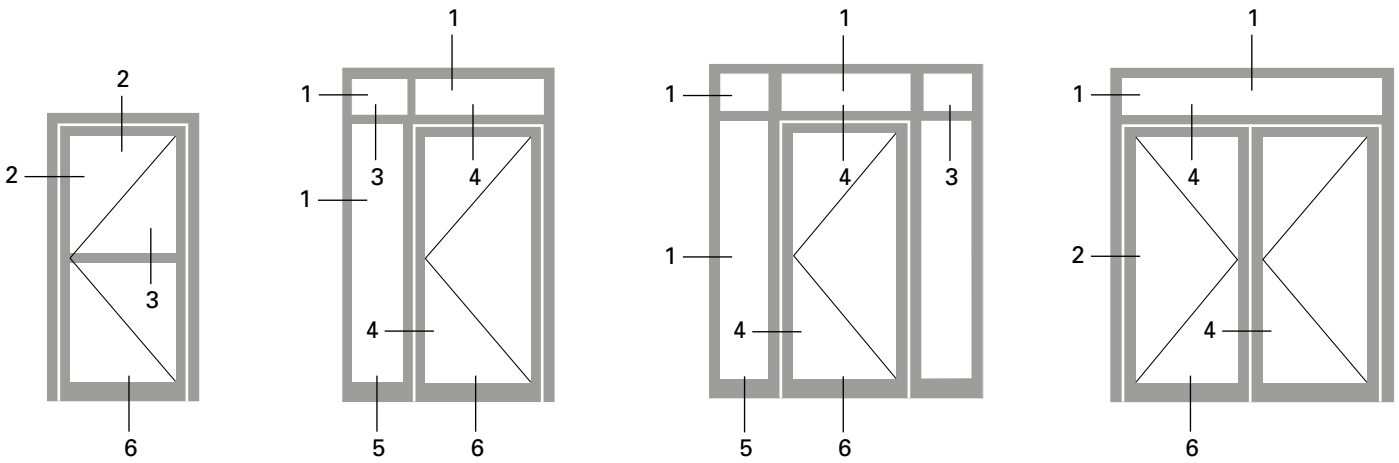

3.0

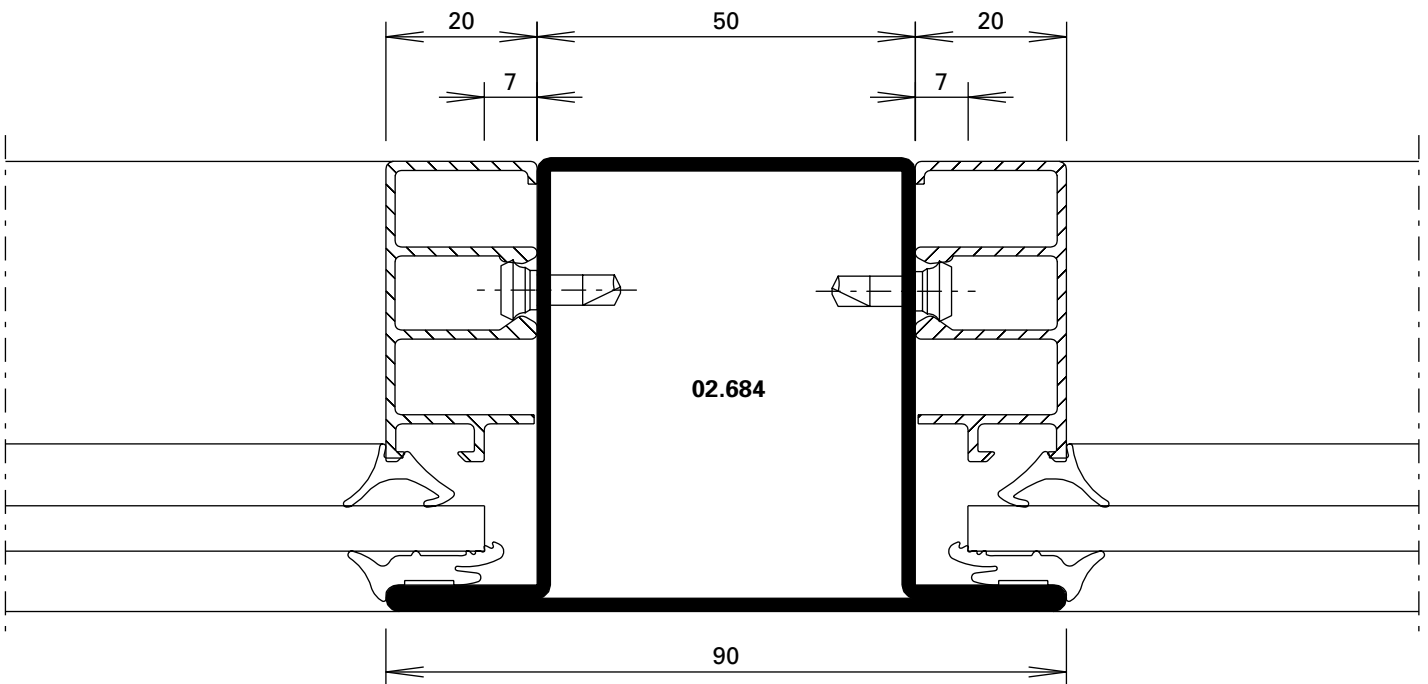

DXF DWG 41-0301-C-007

2.0

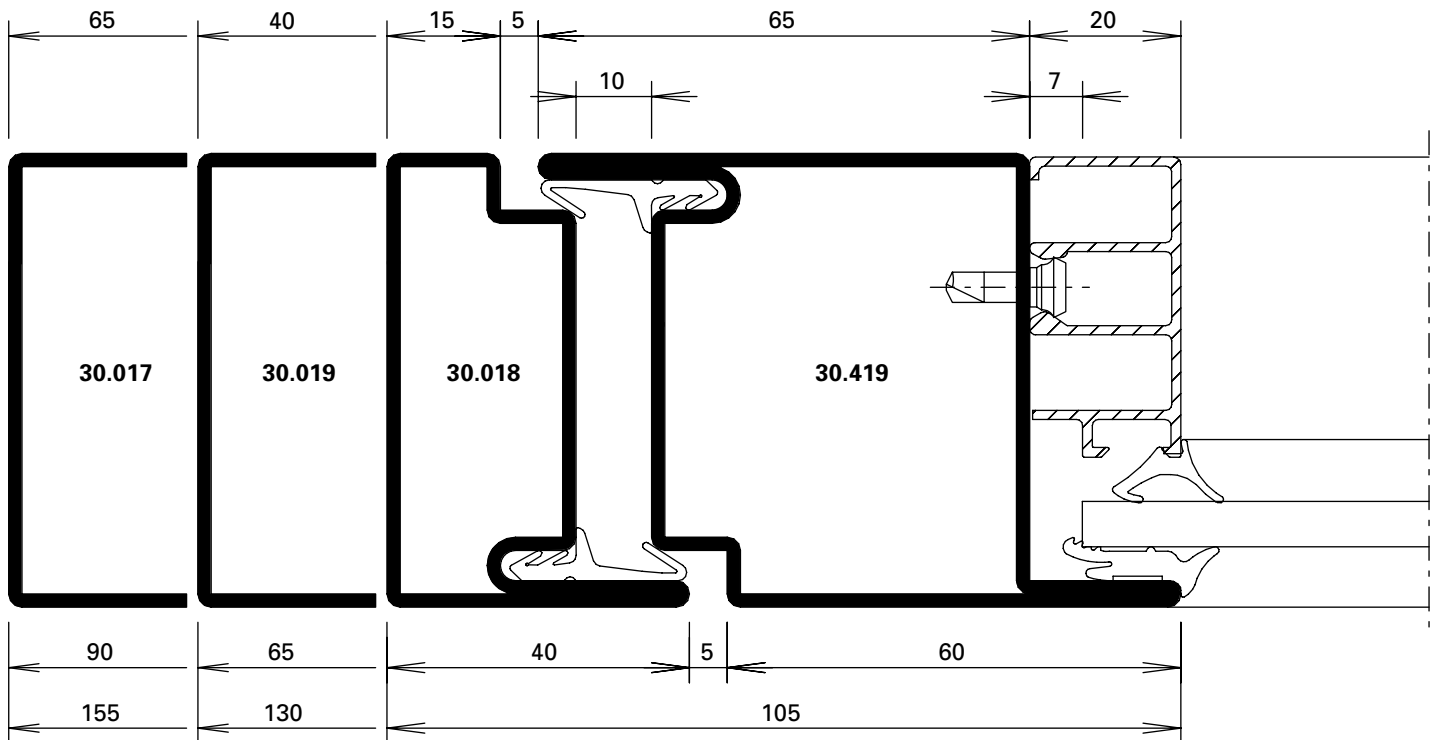

DXF **DWG** 41-0301-C-004

4.0

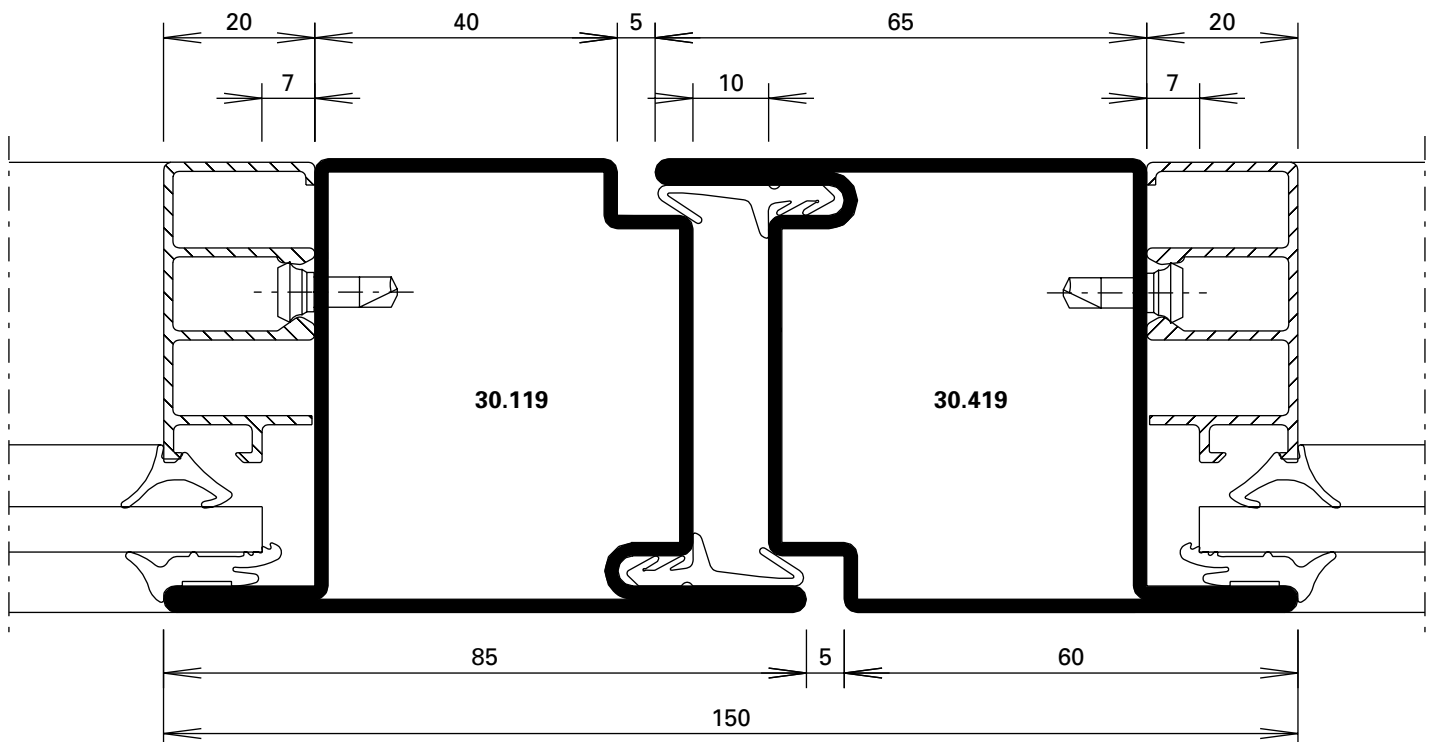

DXF **DWG** 41-0301-C-008

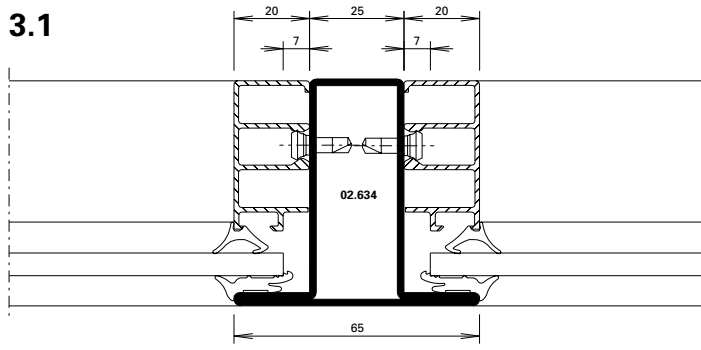
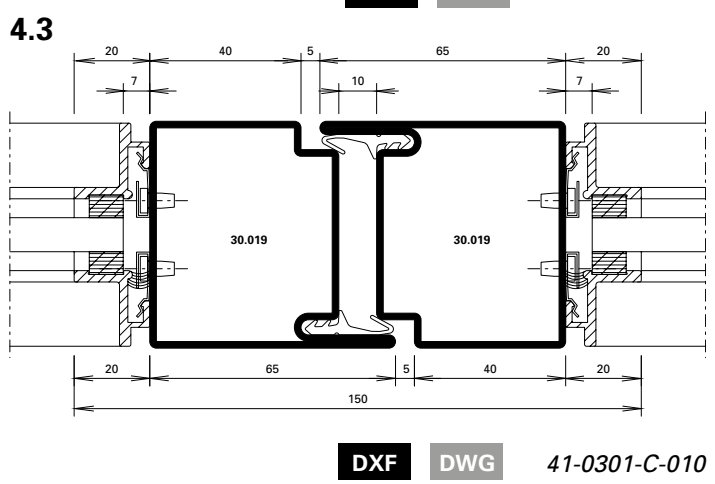
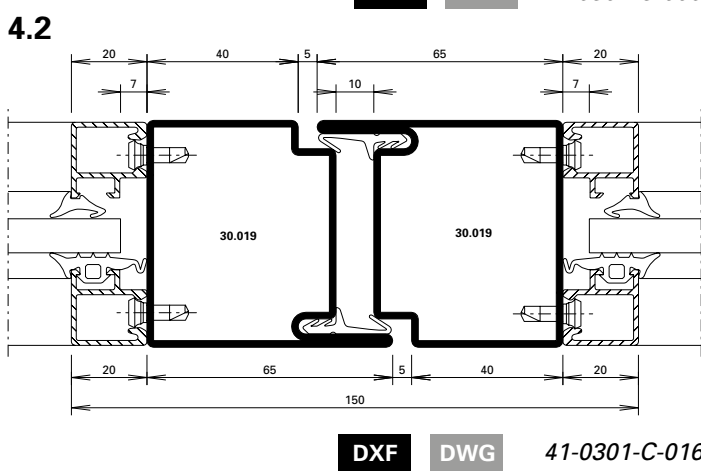
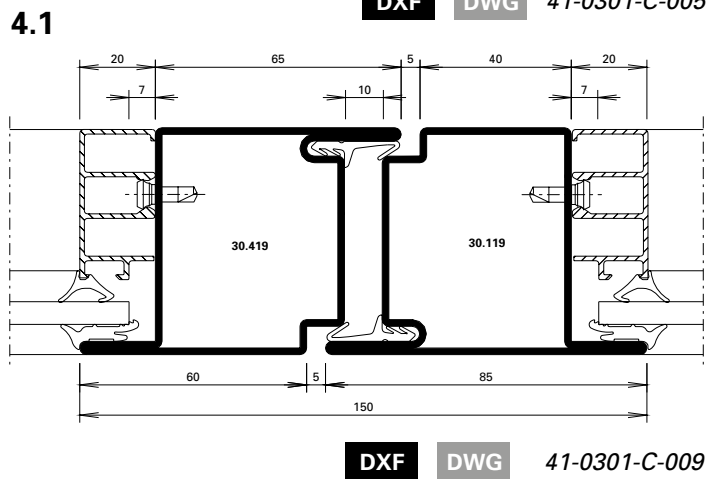
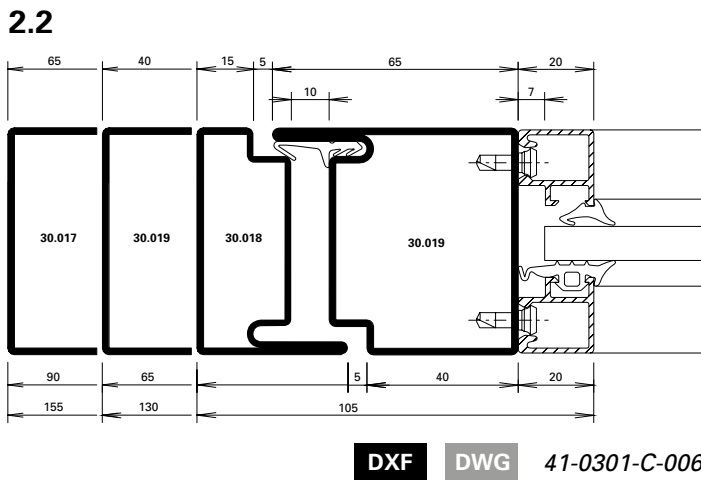
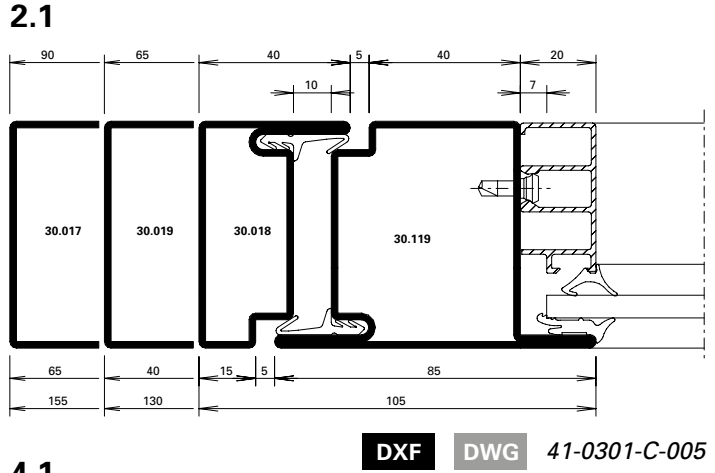
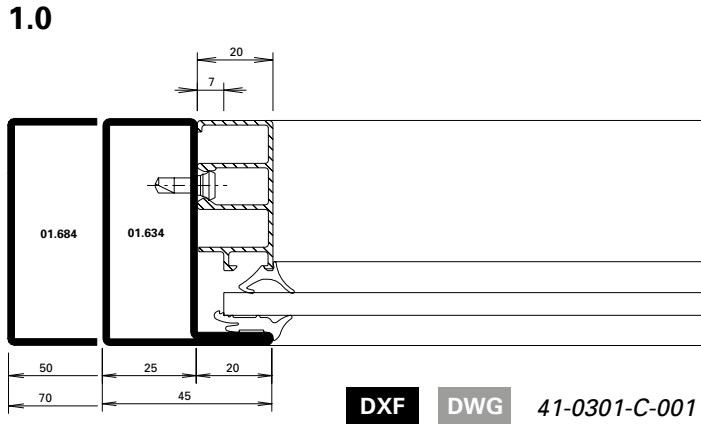

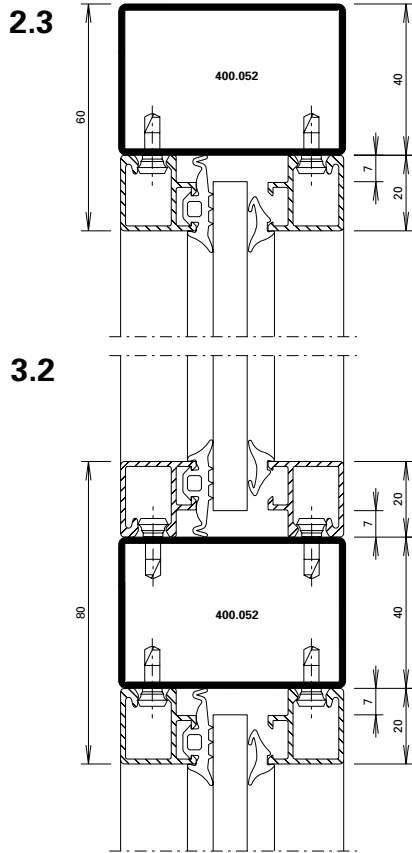

DWG 41-0301-C-002
 DXF

DWG 41-0301-C-003
 DXF

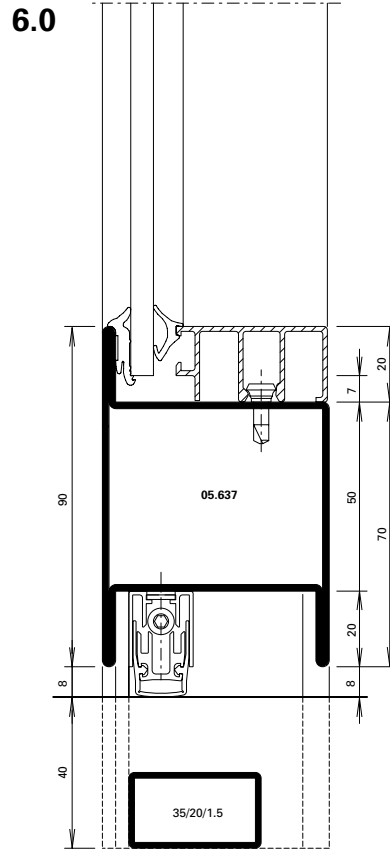

DWG 41-0301-C-012
 DXF

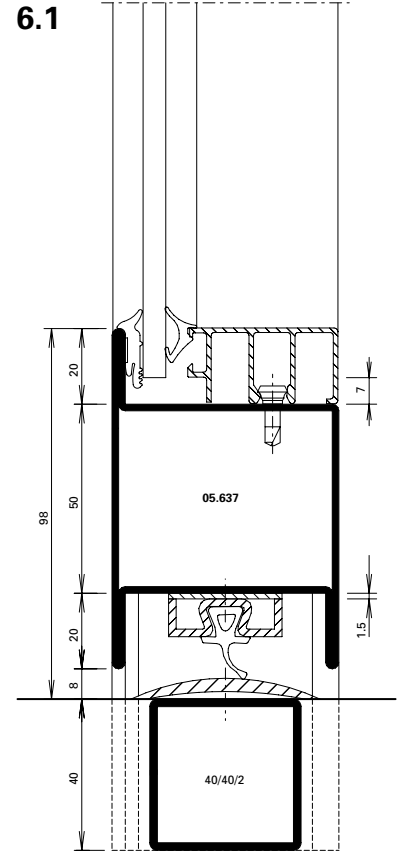

DWG 41-0301-C-013
 DXF

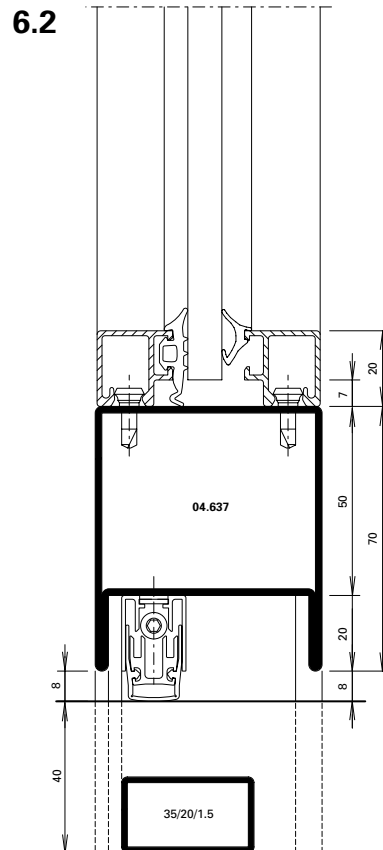

DWG 41-0301-C-014
 DXF

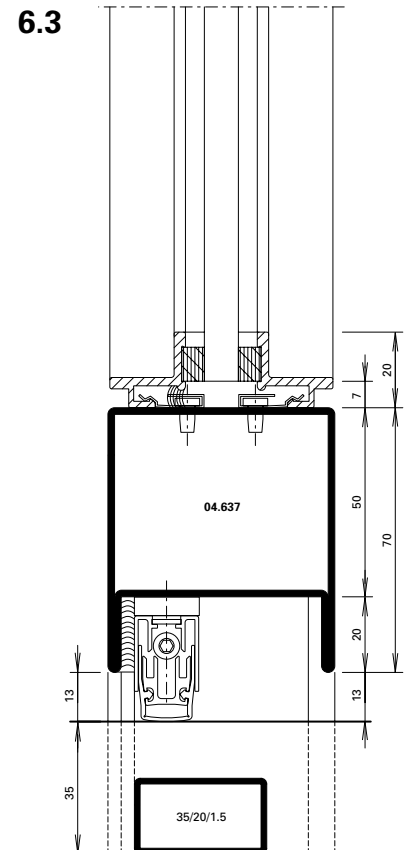

DWG 41-0301-C-015
 DXF

Glasleisten-Varianten im Masstab 1:2
Variantes de parcloles à l'échelle 1:2
Glazing bead options on scale 1:2

Jansen-Economy 60 RS DIN 18095
 Jansen-Economy 60 RS DIN 18095
 Jansen-Economy 60 RS DIN 18095

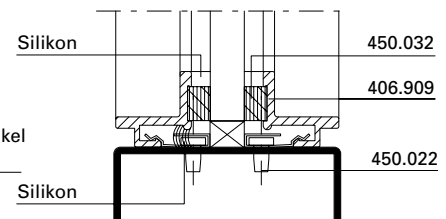
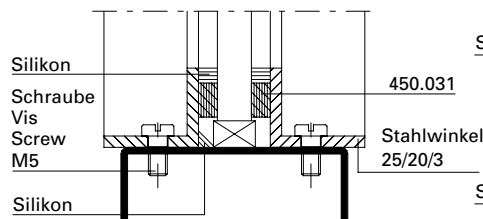
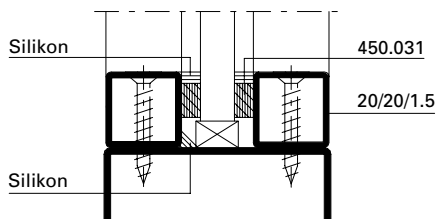
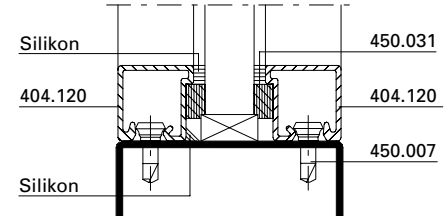
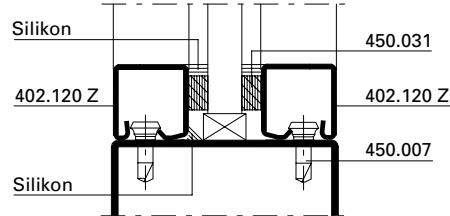
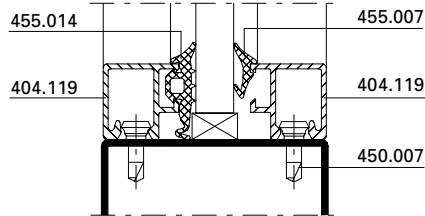
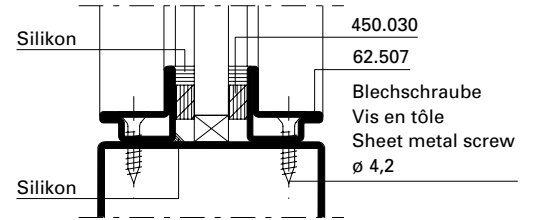
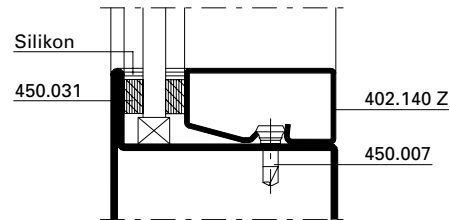
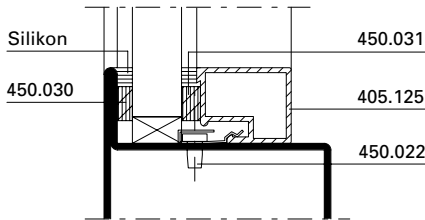
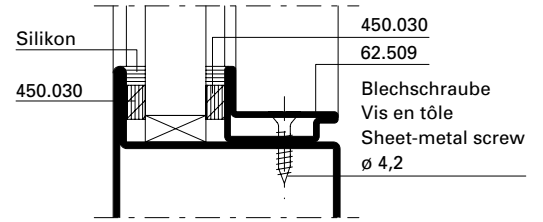
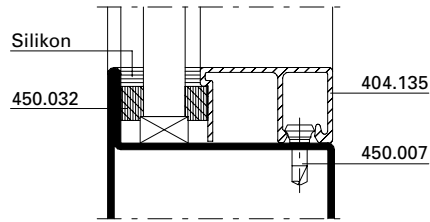
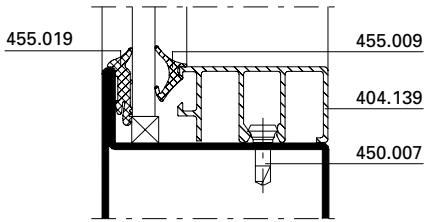

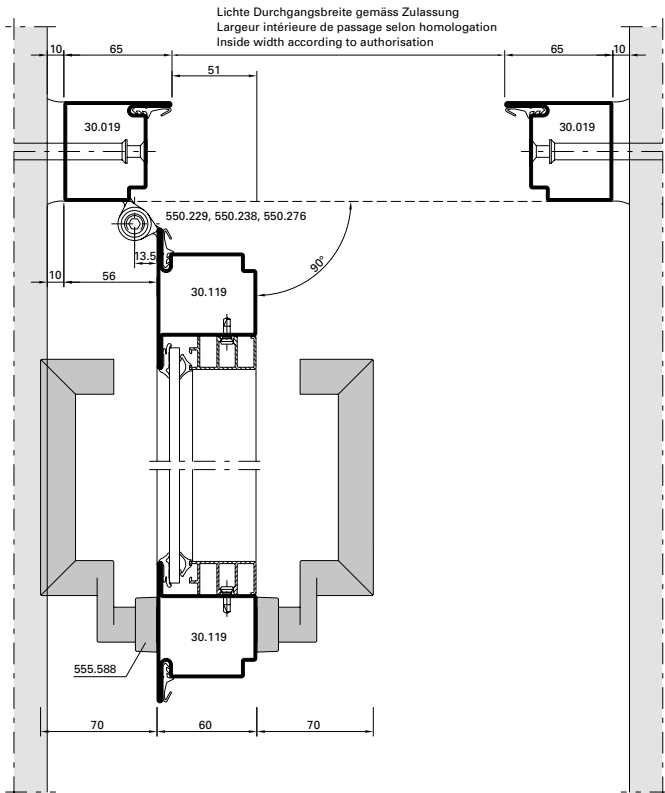

DXF DWG 41-0301-E-013

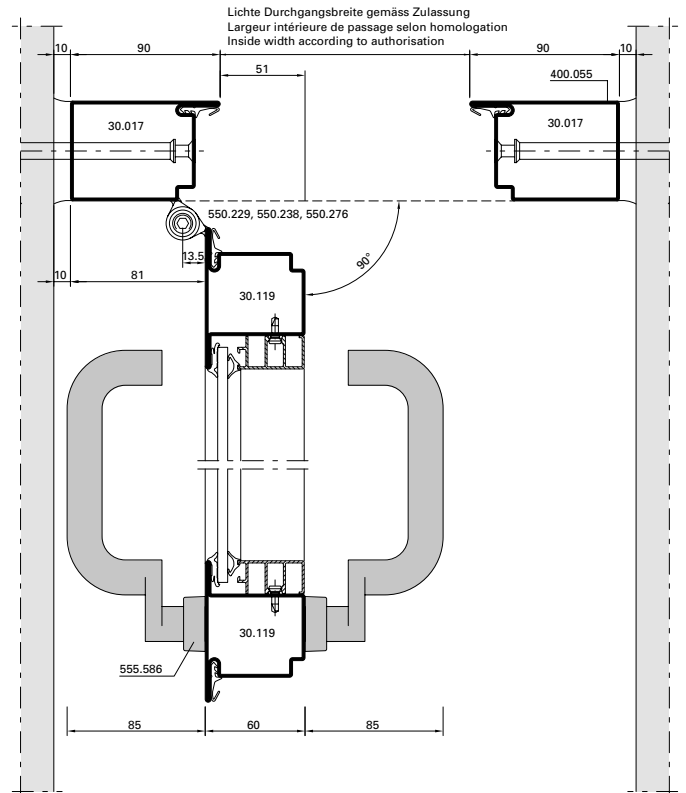

DXF DWG 41-0301-E-014

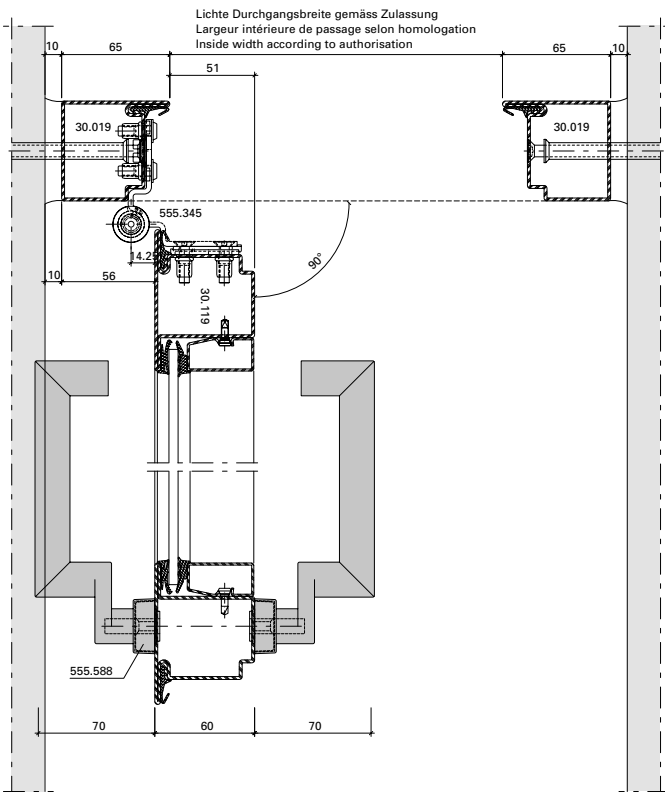

DXF DWG 41-0301-E-015

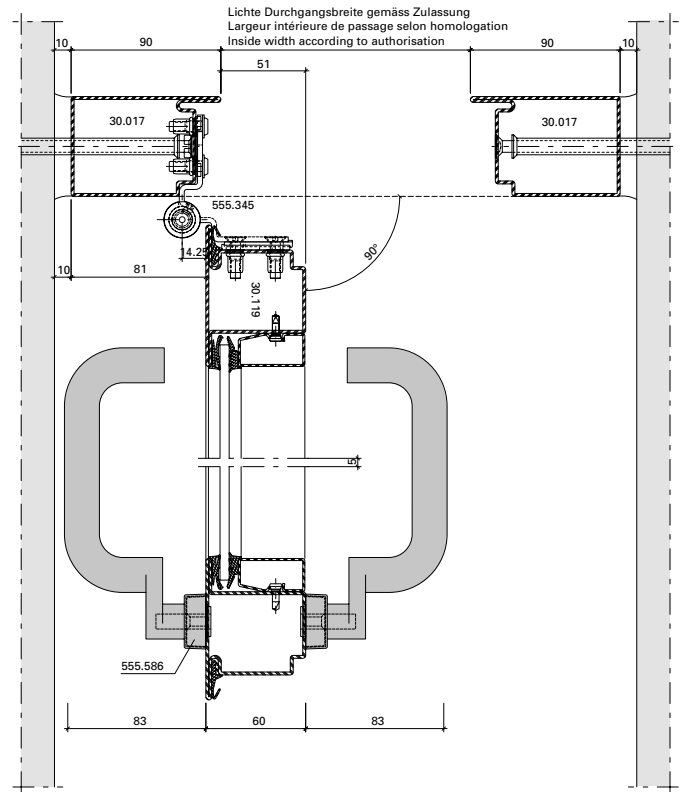

DXF DWG 41-0301-E-016

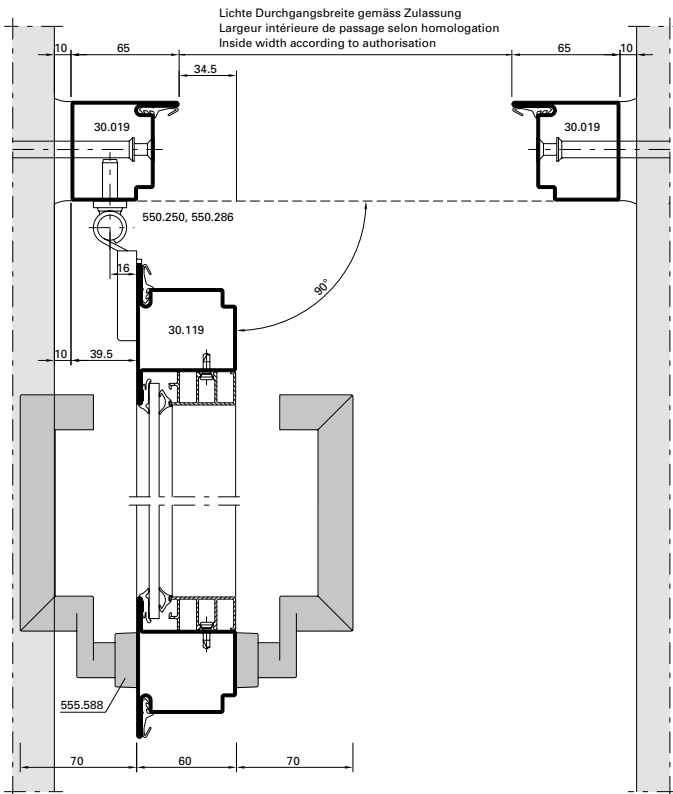

DXF **DWG** 41-0301-E-017

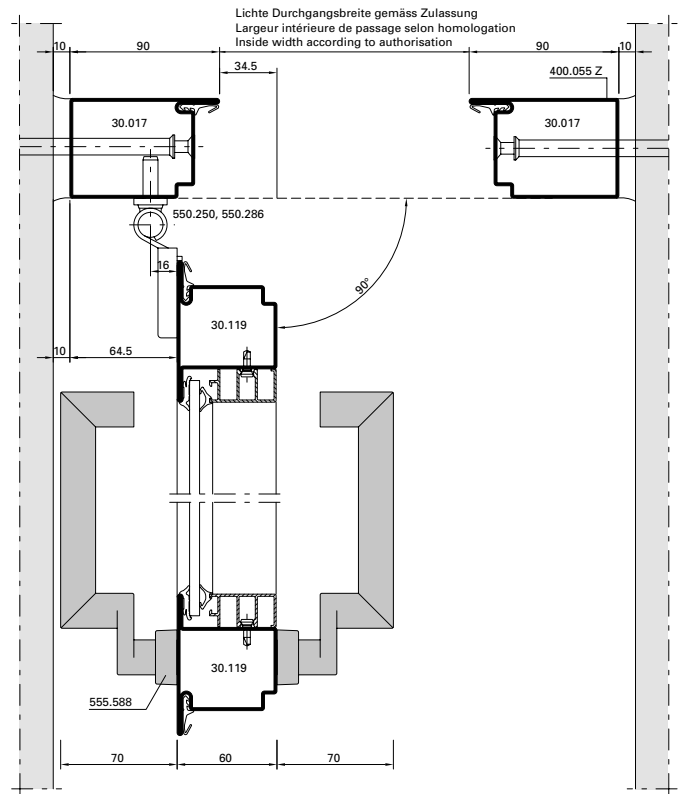

DXF **DWG** 41-0301-E-018

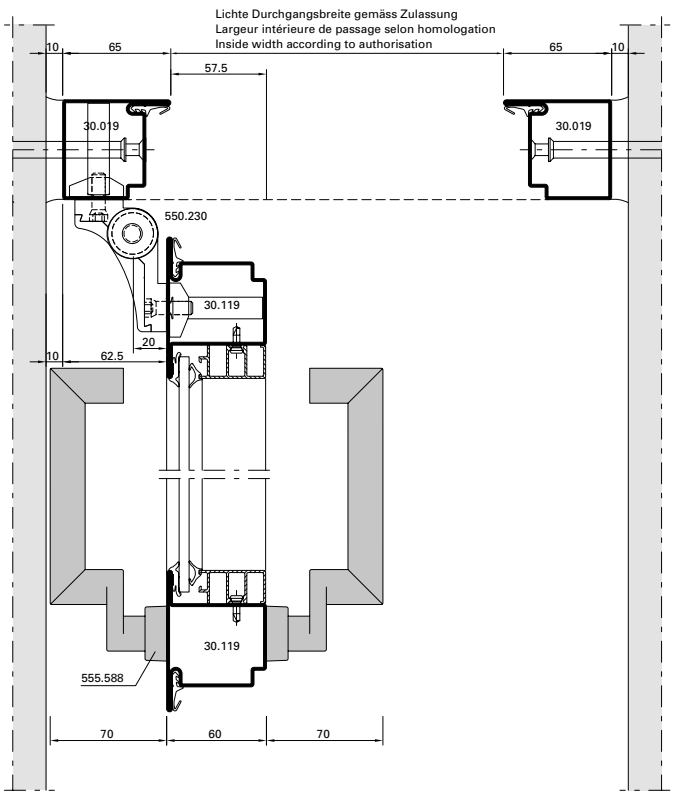

DXF **DWG** 41-0301-E-019

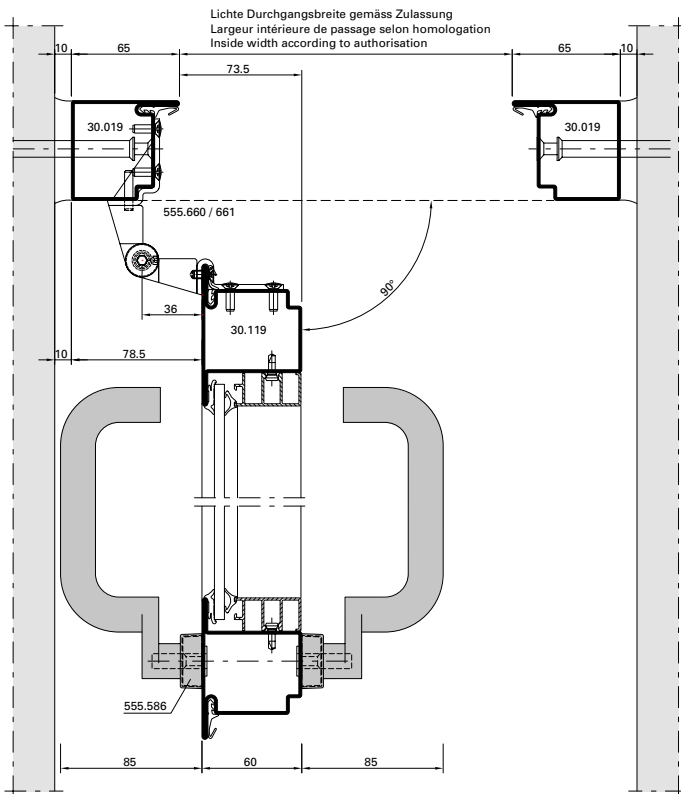

DXF **DWG** 41-0301-E-023

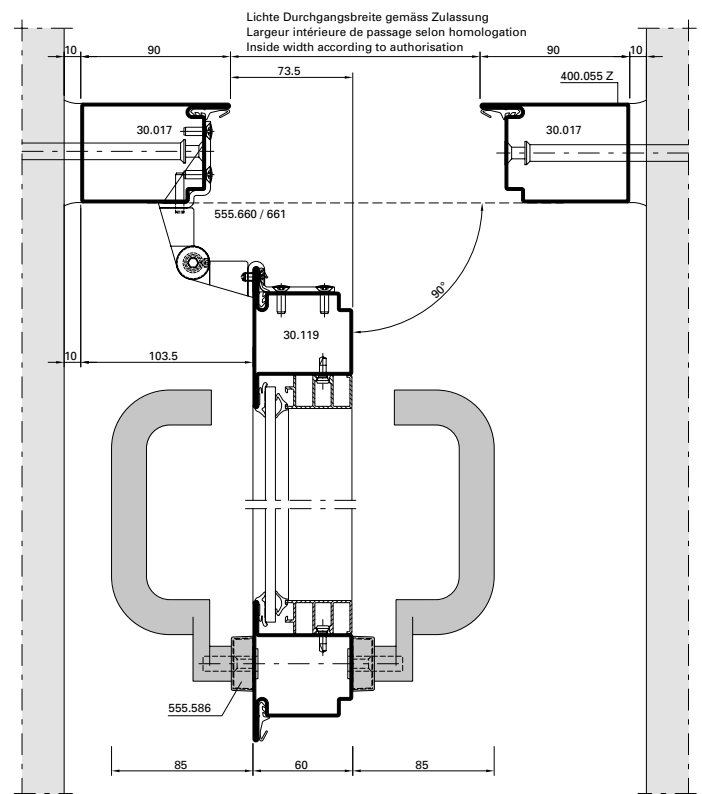

DXF **DWG** 41-0301-E-022

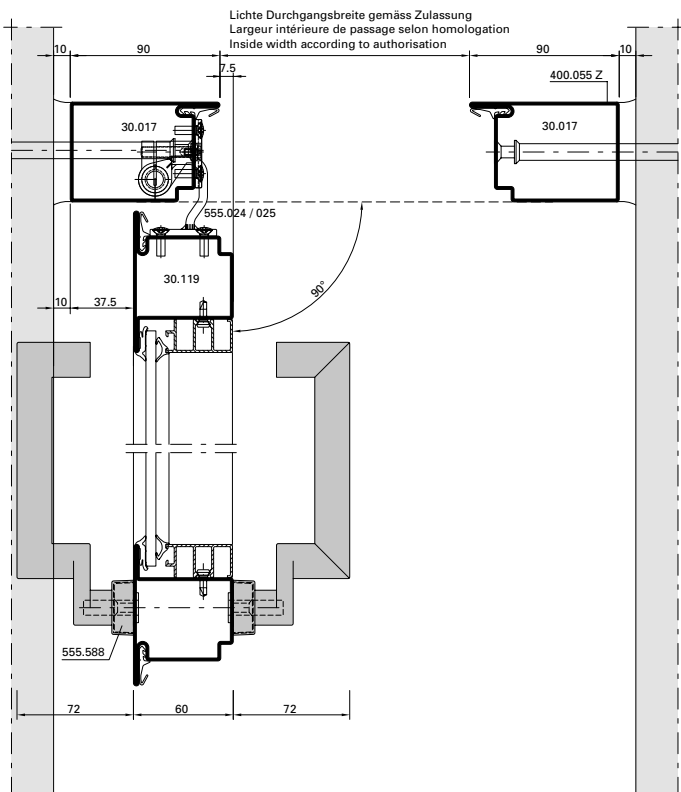

DXF **DWG** 41-0301-E-021

Anschlüsse am Bau im Masstab 1:2

Raccords au mur à l'échelle 1:2

Attachment to structure on scale 1:2

Jansen-Economy 60 RS DIN 18095

Jansen-Economy 60 RS DIN 18095

Jansen-Economy 60 RS DIN 18095

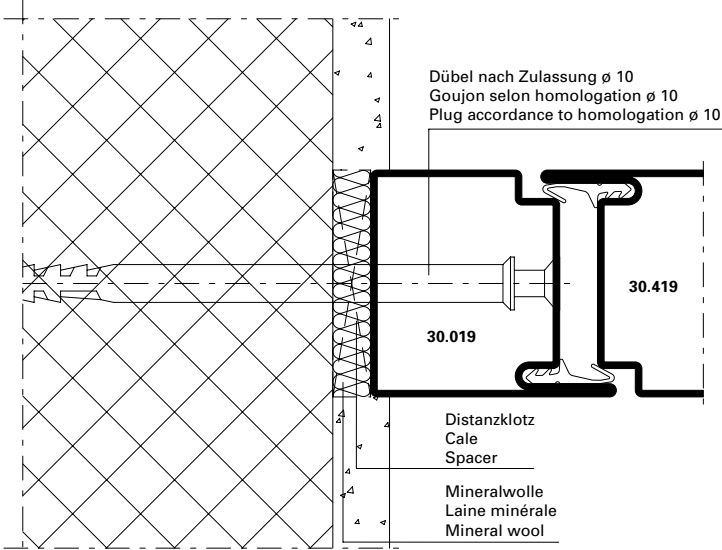

DXF

DWG

41-0301-A-014

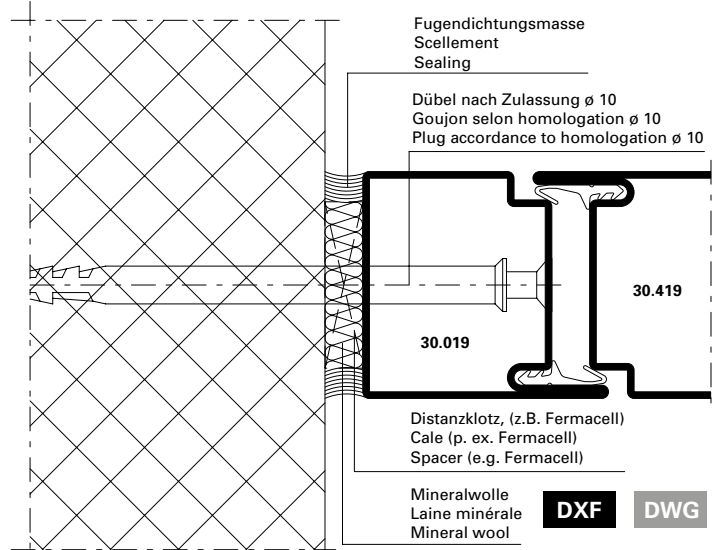

DXF

DWG

41-0301-A-015

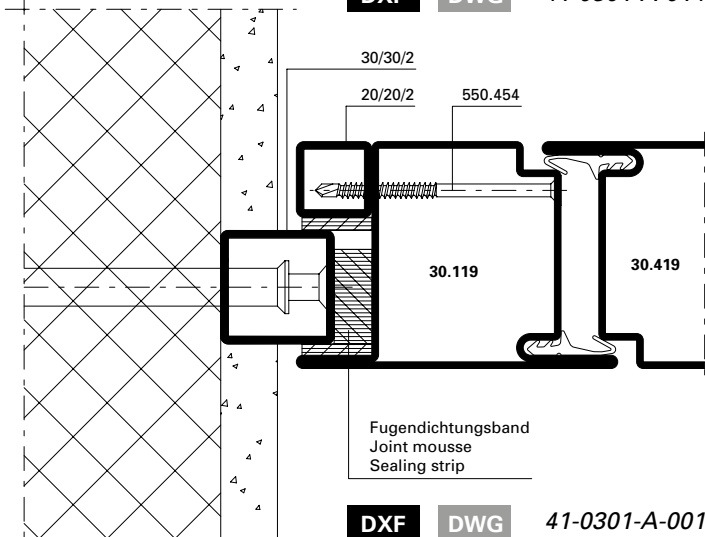

DXF

DWG

41-0301-A-001

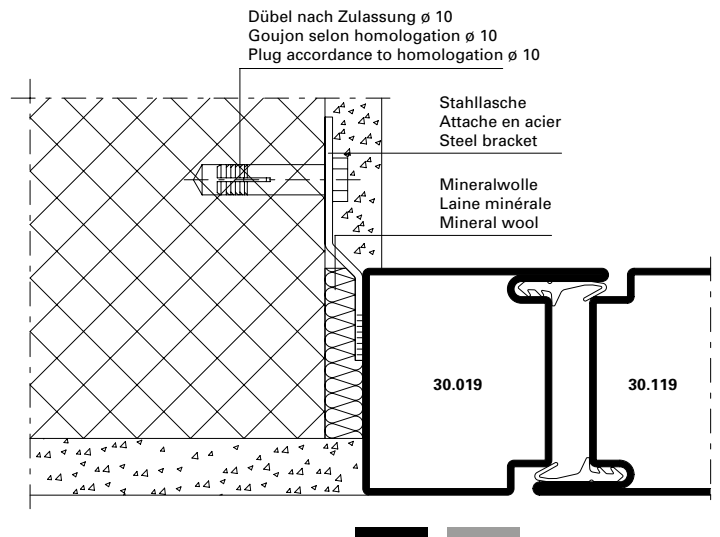

DXF

DWG

41-0301-A-002

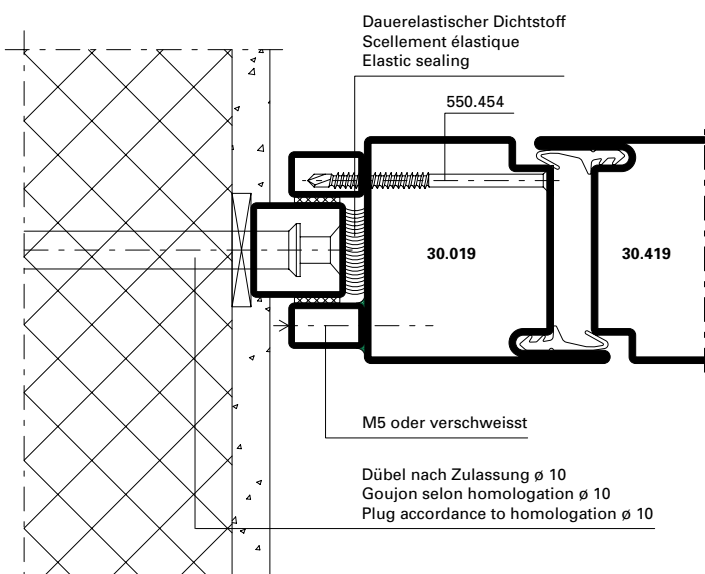

DXF

DWG

41-0301-A-003

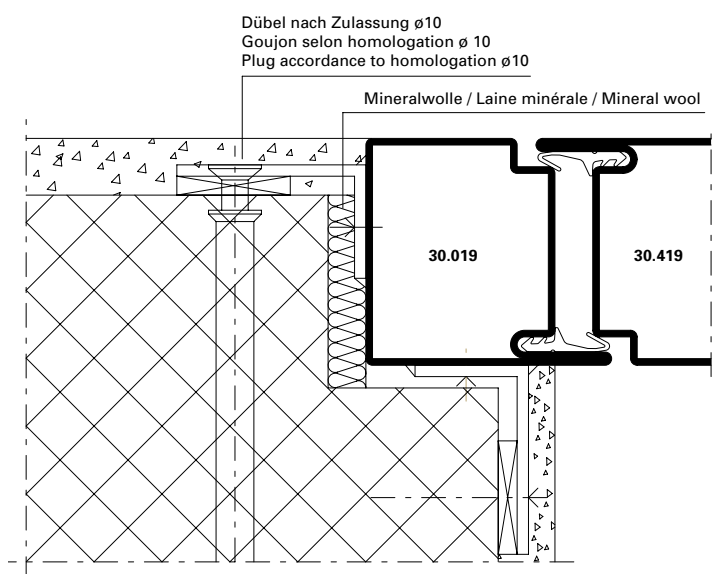

DXF

DWG

41-0301-A-016

Anschlüsse am Bau im Masstab 1:2

Raccords au mur à l'échelle 1:2

Attachment to structure on scale 1:2

Jansen-Economy 60 RS DIN 18095

Jansen-Economy 60 RS DIN 18095

Jansen-Economy 60 RS DIN 18095

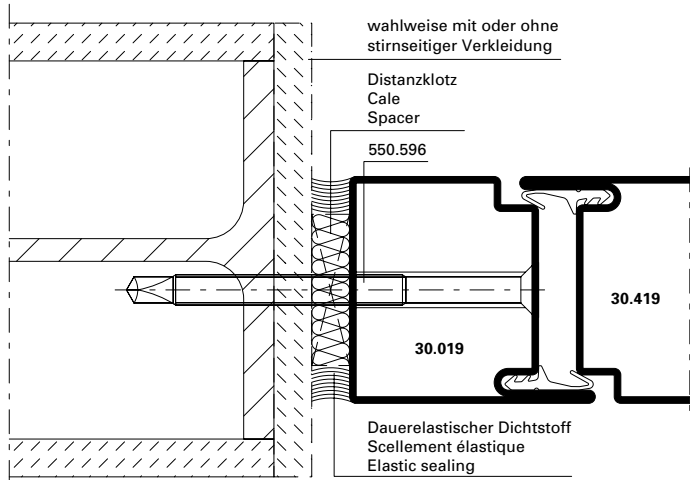

DXF DWG 41-0301-A-004

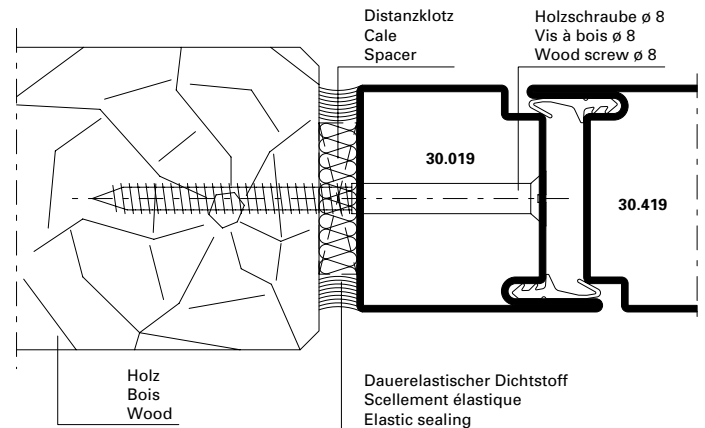

DXF DWG 41-0301-A-005

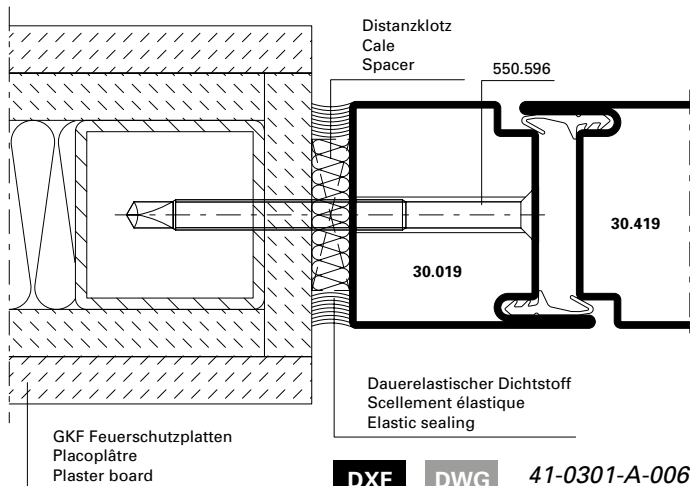

DXF DWG 41-0301-A-006

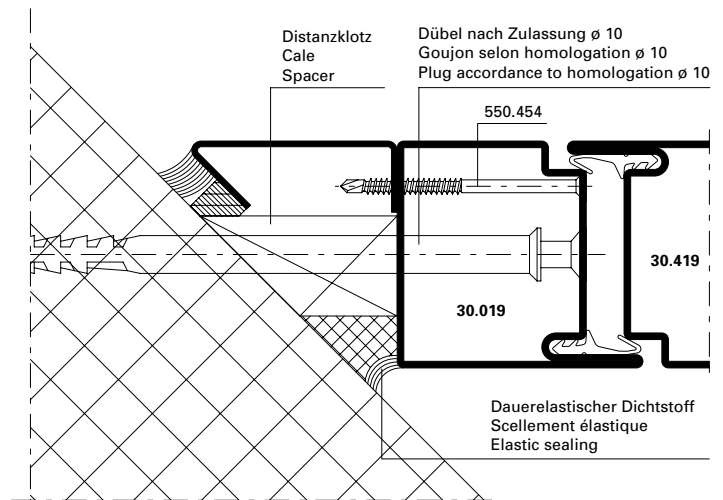

DXF DWG 41-0301-A-007

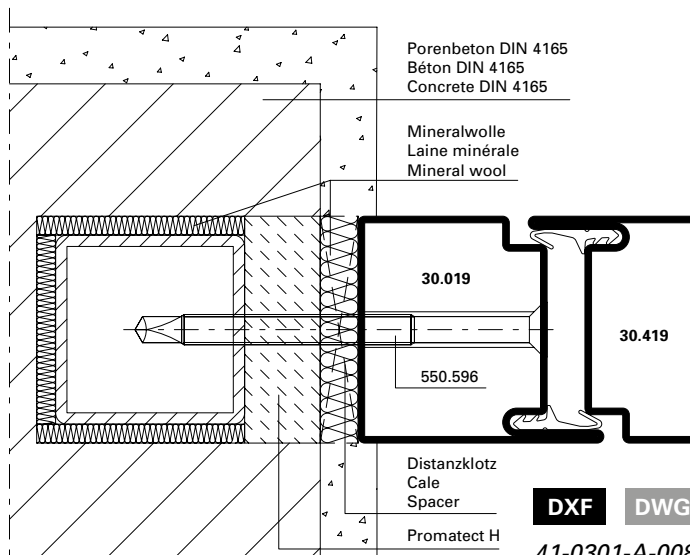

DXF DWG 41-0301-A-008

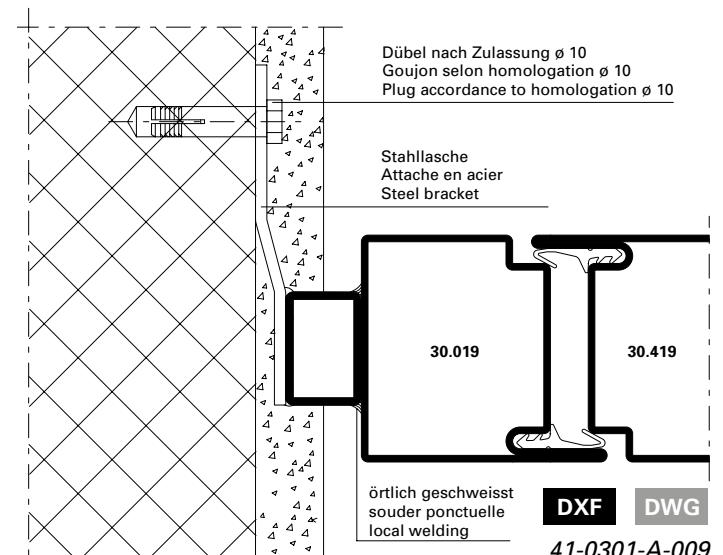

DXF DWG 41-0301-A-009

Anschlüsse am Bau im Massstab 1:2

Raccords au mur à l'échelle 1:2

Attachment to structure on scale 1:2

Jansen-Economy 60 RS DIN 18095

Jansen-Economy 60 RS DIN 18095

Jansen-Economy 60 RS DIN 18095

41-0301-A-011

DXF DWG

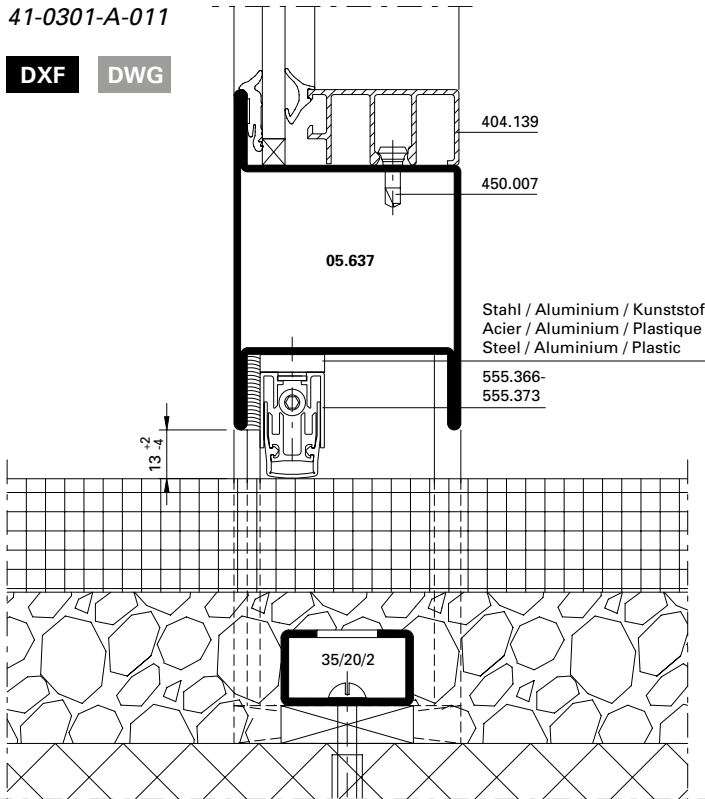

41-0301-A-013

DXF DWG

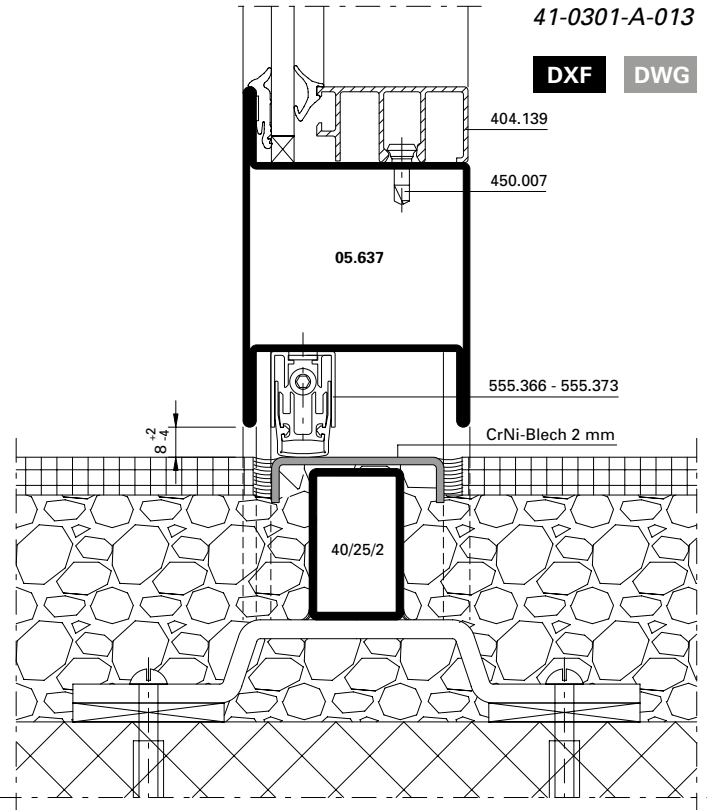

41-0301-A-010

DXF DWG

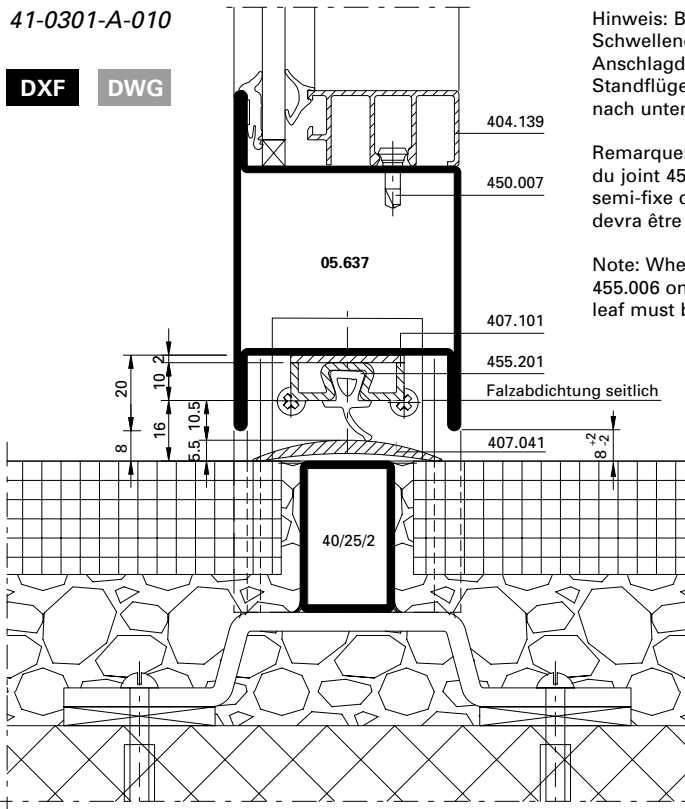

Hinweis: Bei Verwendung der Schwellendichtung 455.201 oder Anschlagdichtung 455.006 muss der Standflügel von zweiflügeligen Türen nach unten verriegelt werden.

Remarque: Dans le cas de l'utilisation du joint 455.201 ou 455.006, le vantail semi-fixe des portes à deux vantaux devra être verrouillé aussi en bas.

Note: When using gasket 455.201 or 455.006 on two leaf doors the fixed leaf must be locked towards the bottom.

41-0301-A-012

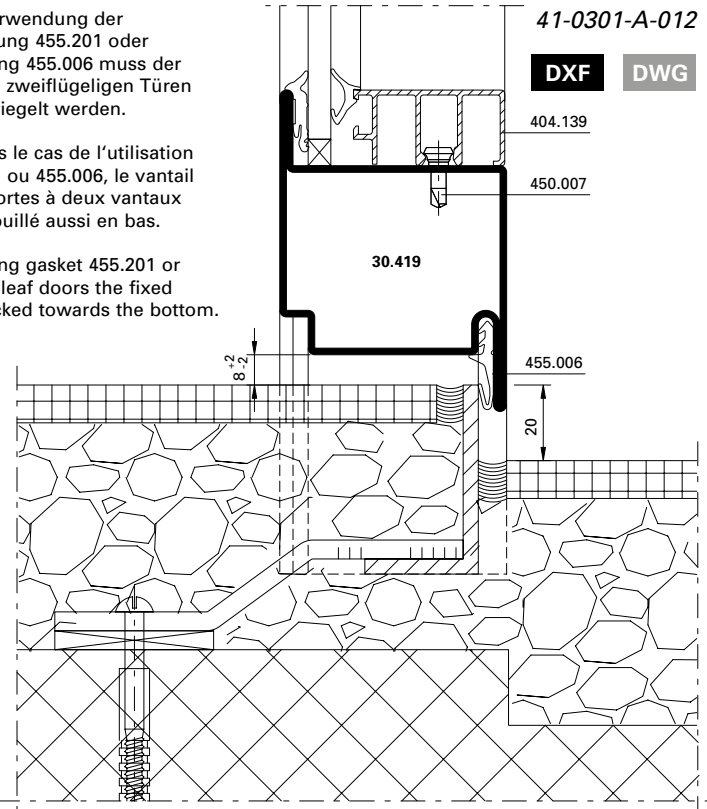

DXF DWG



Einflügelige Türen,
 auswärts öffnend,
 Flügelhöhe ≤ 2200 mm

Porte à un vantail,
 ouvrant vers l'extérieur,
 hauteur du vantail ≤ 2200 mm

Single leaf door,
 outward opening,
 leaf height ≤ 2200 mm

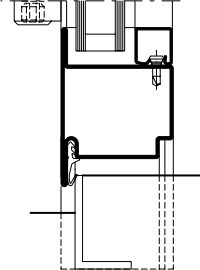
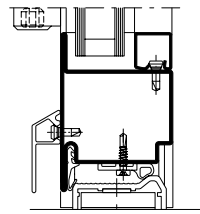
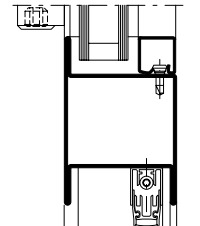
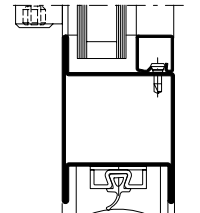
Variante	Beschlag Ferrure Fitting	 EN 12207	 EN 12208	 EN 12210	
Anschlagdichtung Joint de butée Rebate gasket		❶	2	1A	C4
		❷	2	2A	C4
		❸	3	2A	C5
Doppel-Anschlagdichtung Joint de base double Double rebate gasket		❶	4	3A	C4
		❷	4	3A	C4
		❸	4	5A	C5
Senkdichtung Joint seuil Drop seal		❶	2	1A	C4
		❷	2	2A	C4
		❸	3	2A	C5
Auflaufdichtung Joint de contact Ramp seal		❶	2	0	C4
		❷	2	0	C4
		❸	2	0	C5

❶ Fallenriegel-Schloss
 Serrure à mortaiser
 Latch and bolt lock



❷ Schloss mit Obenverriegelung
 Serrure avec verrouillage supérieur
 Lock with top locking point

❸ Mehrfachverriegelungs-Schloss
 Serrure à verrouillage multiple
 Multipoint lock

Einflügelige Türen,
 einwärts öffnend,
 Flügelhöhe ≤ 2200 mm

Porte à un vantail,
 ouvrant vers l'intérieur,
 hauteur du vantail ≤ 2200 mm

Single leaf door,
 inward opening,
 leaf height ≤ 2200 mm

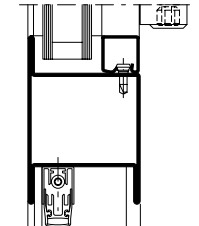
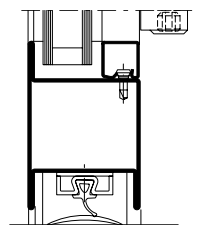
Variante	Beschlag Ferrure Fitting	 EN 12207	 EN 12208	 EN 12210
Senkdichtung Joint seuil Drop seal 	❶	2	0	C4
	❷	2	0	C4
	❸	3	1A	C5
Auflaufdichtung Joint de contact Ramp seal 	❶	2	0	C4
	❷	2	0	C4
	❸	2	0	C5

❶ Fallenriegel-Schloss
 Serrure à mortaiser
 Latch and bolt lock



❷ Schloss mit Obenverriegelung
 Serrure avec verrouillage supérieur
 Lock with top locking point

❸ Mehrfachverriegelungs-Schloss
 Serrure à verrouillage multiple
 Multipoint lock

Einflügelige Türen,
 auswärts öffnend,
 Flügelhöhe ≤ 3000 mm

Porte à un vantail,
 ouvrant vers l'extérieur,
 hauteur du vantail ≤ 3000 mm

Single leaf door,
 outward opening,
 leaf height ≤ 3000 mm

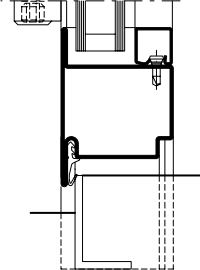
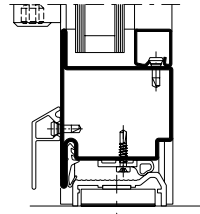
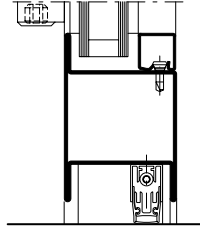
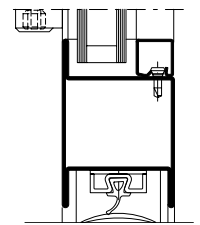
Variante	Beschlag Ferrure Fitting	 EN 12207	 EN 12208	 EN 12210	
Anschlagdichtung Joint de butée Rebate gasket		1	1	0	C1
		2	1	0	C1
		3	1	0	C2
Doppel-Anschlagdichtung Joint de base double Double rebate gasket		1	1	1A	C1
		2	1	1A	C1
		3	2	2A	C2
Senkdichtung Joint seuil Drop seal		1	1	0	C1
		2	1	0	C1
		3	1	0	C2
Auflaufdichtung Joint de contact Ramp seal		1	0	0	C1
		2	0	0	C1
		3	1	0	C2

1 Fallenriegel-Schloss
 Serrure à mortaiser
 Latch and bolt lock



2 Schloss mit Obenverriegelung
 Serrure avec verrouillage supérieur
 Lock with top locking point

3 Mehrfachverriegelungs-Schloss
 Serrure à verrouillage multiple
 Multipoint lock

Einflügelige Türen,
 einwärts öffnend,
 Flügelhöhe ≤ 3000 mm

Porte à un vantail,
 ouvrant vers l'intérieur,
 hauteur du vantail ≤ 3000 mm

Single leaf door,
 inward opening,
 leaf height ≤ 3000 mm

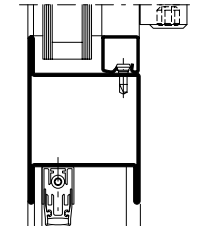
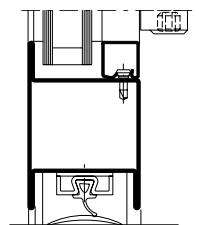
Variante	Beschlag Ferrure Fitting	 EN 12207	 EN 12208	 EN 12210	
Senkdichtung Joint seuil Drop seal		1 1 2 1 3 1	1 0 0	0 0 0	C1 C1 C2
Auflaufdichtung Joint de contact Ramp seal		1 0 2 0 3 1	0 0 1	0 0 0	C1 C1 C2

1 Fallenriegel-Schloss
 Serrure à mortaiser
 Latch and bolt lock





2 Schloss mit Obenverriegelung
 Serrure avec verrouillage supérieur
 Lock with top locking point

3 Mehrfachverriegelungs-Schloss
 Serrure à verrouillage multiple
 Multipoint lock

Zweiflügelige Türen,
 auswärts öffnend,
 Flügelhöhe ≤ 2200 mm

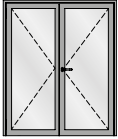
Porte à deux vantaux,
 ouvrant vers l'extérieur,
 hauteur du vantail ≤ 2200 mm

Double leaf door,
 outward opening,
 leaf height ≤ 2200 mm

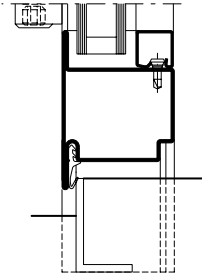
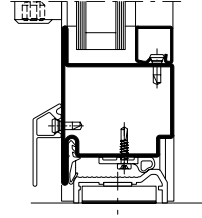
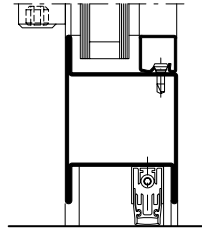
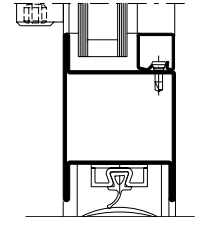
Variante		Beschlag Ferrure Fitting	 EN 12207	 EN 12208	 EN 12210
Anschlagdichtung Joint de butée Rebate gasket		❶	2	1A	C2
		❷	2	2A	C2
		❸	2	2A	C3
Doppel-Anschlagdichtung Joint de base double Double rebate gasket		❶	2	2A	C2
		❷	2	2A	C2
		❸	3	3A	C3
Senkdichtung Joint seuil Drop seal		❶	2	1A	C2
		❷	2	2A	C2
		❸	2	2A	C3
Auflaufdichtung Joint de contact Ramp seal		❶	2	0	C2
		❷	2	0	C2
		❸	2	0	C3

❶ Fallenriegel-Schloss
 Serrure à mortaiser
 Latch and bolt lock





❷ Schloss mit Obenverriegelung
 Serrure avec verrouillage supérieur
 Lock with top locking point

❸ Mehrfachverriegelungs-Schloss
 Serrure à verrouillage multiple
 Multipoint lock

Zweiflügelige Türen,
 einwärts öffnend,
 Flügelhöhe ≤ 2200 mm

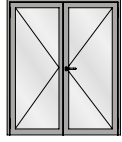
Porte à deux vantaux,
 ouvrant vers l'intérieur,
 hauteur du vantail ≤ 2200 mm

Double leaf door,
 inward opening,
 leaf height ≤ 2200 mm

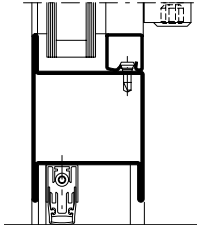
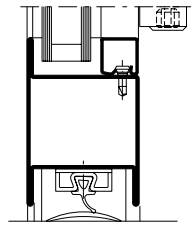
Variante		Beschlag Ferrure Fitting	 EN 12207	 EN 12208	 EN 12210
Senkdichtung Joint seuil Drop seal		❶	2	0	C2
		❷	2	0	C2
		❸	2	0	C3
Auflaufdichtung Joint de contact Ramp seal		❶	2	0	C2
		❷	2	0	C2
		❸	2	0	C3

❶ Fallenriegel-Schloss
 Serrure à mortaiser
 Latch and bolt lock





❷ Schloss mit Obenverriegelung
 Serrure avec verrouillage supérieur
 Lock with top locking point

❸ Mehrfachverriegelungs-Schloss
 Serrure à verrouillage multiple
 Multipoint lock

Zweiflügelige Türen,
 auswärts öffnend,
 Flügelhöhe ≤ 3000 mm

Porte à deux vantaux,
 ouvrant vers l'extérieur,
 hauteur du vantail ≤ 3000 mm

Double leaf door,
 outward opening,
 leaf height ≤ 3000 mm

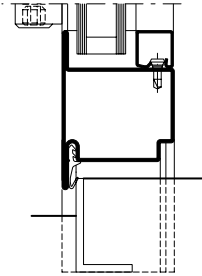
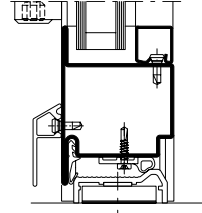
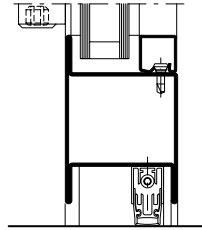
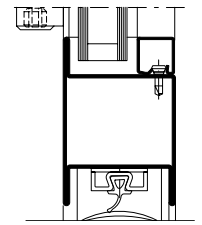
Variante		Beschlag Ferrure Fitting	 EN 12207	 EN 12208	 EN 12210
Anschlagdichtung Joint de butée Rebate gasket		❶	0	0	C1
		❷	0	0	C1
		❸	1	0	C2
Doppel-Anschlagdichtung Joint de base double Double rebate gasket		❶	1	0	C1
		❷	1	0	C1
		❸	2	0	C2
Senkdichtung Joint seuil Drop seal		❶	0	0	C1
		❷	0	0	C1
		❸	1	0	C2
Auflaufdichtung Joint de contact Ramp seal		❶	0	0	C1
		❷	0	0	C1
		❸	1	0	C2

❶ Fallenriegel-Schloss
 Serrure à mortaiser
 Latch and bolt lock





❷ Schloss mit Obenverriegelung
 Serrure avec verrouillage supérieur
 Lock with top locking point

❸ Mehrfachverriegelungs-Schloss
 Serrure à verrouillage multiple
 Multipoint lock

Zweiflügelige Türen,
 einwärts öffnend,
 Flügelhöhe ≤ 3000 mm

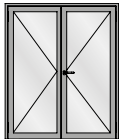
Porte à deux vantaux,
 ouvrant vers l'intérieur,
 hauteur du vantail ≤ 3000 mm

Double leaf door,
 inward opening,
 leaf height ≤ 3000 mm

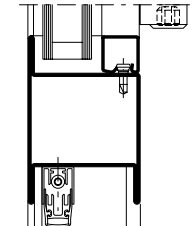
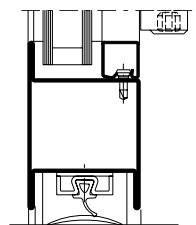
Variante		Beschlag Ferrure Fitting	 EN 12207	 EN 12208	 EN 12210
Senkdichtung Joint seuil Drop seal		①	0	0	C1
		②	0	0	C1
		③	1	0	C2
Auflaufdichtung Joint de contact Ramp seal		①	0	0	C1
		②	0	0	C1
		③	1	0	C2

U_f-Werte
(nach EN ISO 10077-2:2018-01)

Auf den folgenden Seiten finden Sie die U_f-Werte für die verschiedenen Anwendungen von Jansen-Economy 60 RS.

Sie basieren auf folgenden Grundlagen:

Stahl

- Profile bandverzinkter Stahl, unbeschichtet
- Stahl-Glasleisten
- Trockenverglasung
- Nassverglasung

Valeurs U_f
(selon EN ISO 10077-2:2018-01)

Vous trouverez les valeurs U_f pour les différentes applications Jansen-Economy 60 RS. dans les pages qui suivent.

Elles se basent sur les principes suivants:

Acier

- Profilés en bande d'acier zingué, sans revêtement
- Parcloses en acier
- Vitrage à sec
- Vitrage à mastic

U_f values
(according to
EN ISO 10077-2:2018-01)

On the following pages you will find the U_f values for the various applications for Jansen-Economy 60 RS.

They are based on the following:

Steel

- Strip galvanised steel profiles, uncoated
- Steel glazing beads
- Glazing with dry glazing
- Glazing with sealing

U_f-Werte
 (nach EN ISO 10077-2:2018-01)

Valeurs U_f
 (selon EN ISO 10077-2:2018-01)

U_f values
 (according to EN ISO 10077-2:2018-01)

 © ift Rosenheim	Füllelementstärken Elements de remplissages Infill elements > 24 mm
	5,5 W/m ² K
	5,6 W/m ² K
	5,3 W/m ² K
	5,3 W/m ² K
	5,3 W/m ² K
	5,3 W/m ² K
	5,6 W/m ² K
	5,7 W/m ² K

 © ift Rosenheim	Füllelementstärken Elements de remplissages Infill elements > 24 mm
	5,7 W/m ² K
	5,8 W/m ² K
	5,5 W/m ² K
	5,5 W/m ² K
	6,0 W/m ² K
	6,1 W/m ² K
	6,9 W/m ² K
	6,1 W/m ² K

U_f-Werte
 (nach EN ISO 10077-2:2018-01)

Valeurs U_f
 (selon EN ISO 10077-2:2018-01)

U_f values
 (according to EN ISO 10077-2:2018-01)

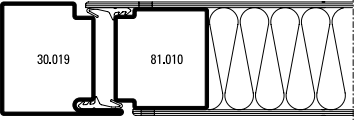
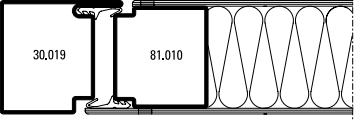
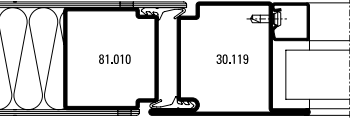
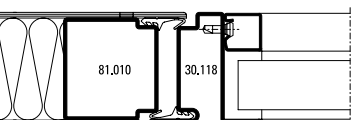
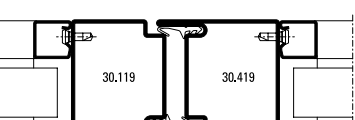
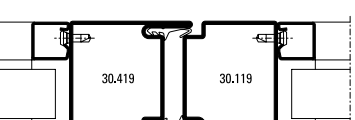
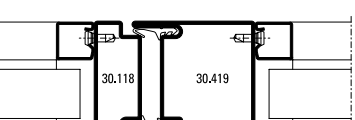
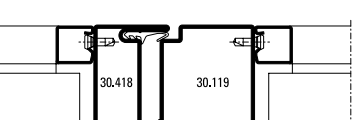
	Füllelementstärken Elements de remplissages Infill elements > 24 mm
	5,3 W/m²K
	5,3 W/m²K
	5,7 W/m²K
	6,0 W/m²K
	5,8 W/m²K
	5,8 W/m²K
	6,1 W/m²K
	6,1 W/m²K

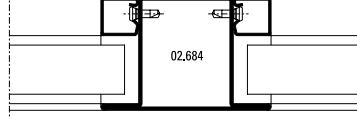
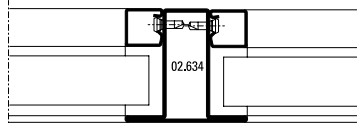
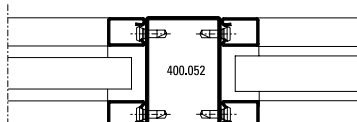

	Füllelementstärken Elements de remplissages Infill elements > 24 mm
	6,3 W/m²K
	7,2 W/m²K
	6,4 W/m²K*

- * Nassverglasung
- * Vitrage à mastic
- * Glazing with sealing

U_f-Werte
 (nach EN ISO 10077-2:2018-01)

Valeurs U_f
 (selon EN ISO 10077-2:2018-01)

U_f values
 (according to EN ISO 10077-2:2018-01)

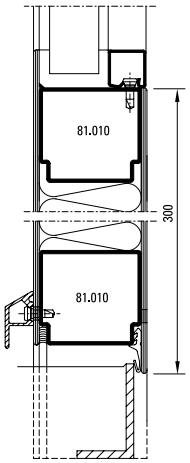
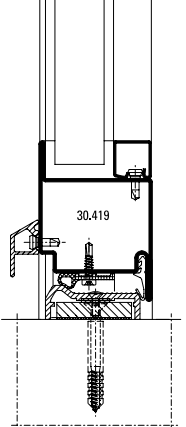
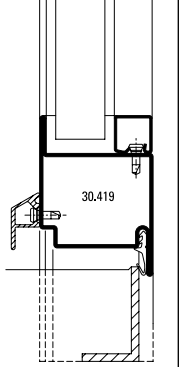
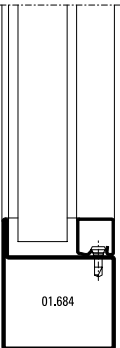
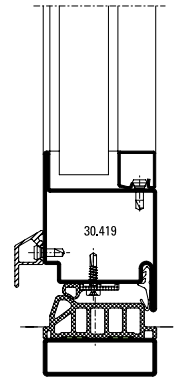
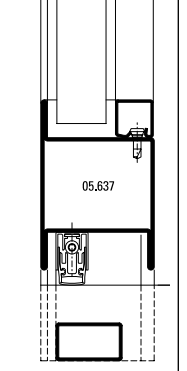
 <p>Füllelementstärken Elements de remplissages Infill elements > 24 mm</p>		 <p>Füllelementstärken Elements de remplissages Infill elements > 24 mm</p>		 <p>Füllelementstärken Elements de remplissages Infill elements > 24 mm</p>	
	<p>4,4 W/m²K</p>		<p>6,1 W/m²K</p>		<p>6,8 W/m²K</p>
	<p>6,1 W/m²K</p>		<p>5,6 W/m²K</p>		<p>5,6 W/m²K</p>



Schallschutz

Ausführungsvarianten

Die nachfolgende Typenübersicht ergibt einen Überblick über die beurteilten Varianten.

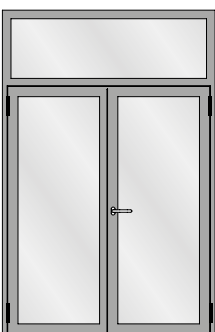
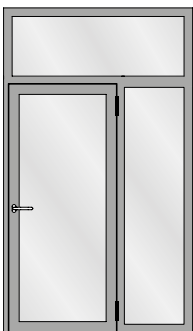
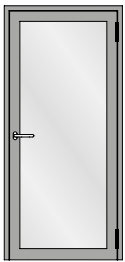

Isolation phonique

Modèles

L'aperçu des types suivant fournit une vue d'ensemble des variantes examinées.

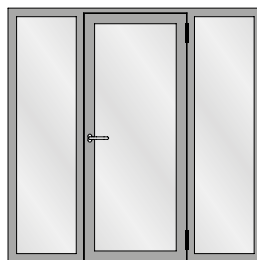
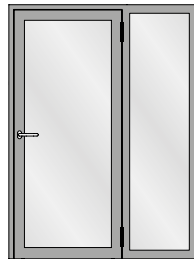
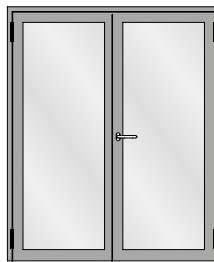

Sound insulation

Design range

The following overview of types provides an overview of the evaluated designs.

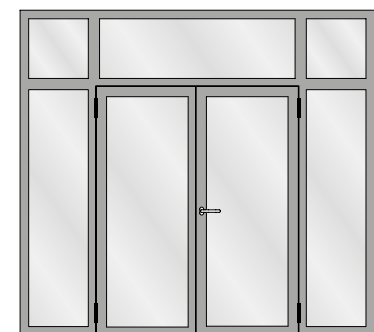
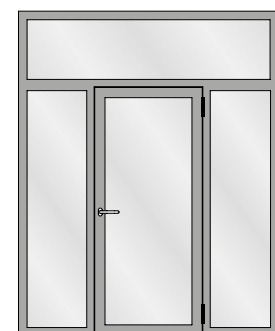

Schallschutz

Isolation phonique

Sound insulation

Tabelle A1

Korrekturtabelle für Jansen-Economy-Türen mit Glasfüllungen

Tableau A1

Tableau de correction pour les portes Jansen-Economy avec vitrage

Table A1

Correction table for Jansen-Economy doors with glass

	1	2	3	4	5	6	7	8	9	10	11
	Türe mit zwei absenkba- ren Bodendichtungen Porte avec deux joint seuil automatique Door with two threshold gaskets that can be lowered R_w (C, Ctr) dB	Glas Verre Glass $R_{w, P, Glas}$ dB	Korrekturen Corrections Corrections K_S dB K_{FV} dB K_{Nass} dB K_{1aB} dB $K_{W/S}$ dB $K_{G 0,4}$ dB $K_{G 1,8}$ dB $K_{G 2,6}$ dB $K_{G 3,2}$ dB								
1	32 (-1; -5)	31	0	-1	0	0	0	0	-1	-2	-3
2	33 (-1; -5)	32	0	-1	0	0	0	0	-1	-2	-3
3	35 (-1; -5)	34	0	-1	0	0	0	0	-1	-2	-3
4	36 (-2; -5)	35	0	-1	-1	0	0	0	-1	-2	-3
5	37 (-2; -5)	37	0	0	-1	0	-1	0	-1	-2	-3
6	38 (-2; -5)	39	0	0	-1	-1	-1	0	-1	-2	-3
7	39 (-2; -5)	40	0	0	-1	-1	-1	0	-1	-2	-3
8	40 (-2; -5)	41	0	0	-1	-1	-2	-1	-1	-2	-3
9	41 (-2; -5)	42	0	0	-1	-1	-2	-2	-1	-2	-3
10	42 (-2; -5)	43	-1	0	-1	-1	-2	-2	-1	-2	-3
11	42 (-2; -5)	44	-1	0	-1	-1	-2	-2	-1	-2	-3
12	43 (-2; -5)	45	-1	+1	-1	-1	-3	-3	-1	-2	-3
13	44 (-2; -5)	49	-1	+1	-1	-2	-3	-3	-1	-2	-3

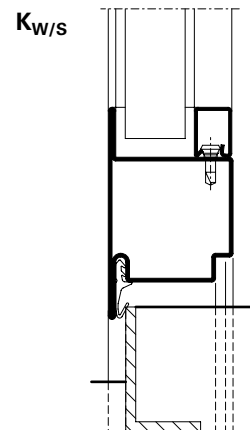
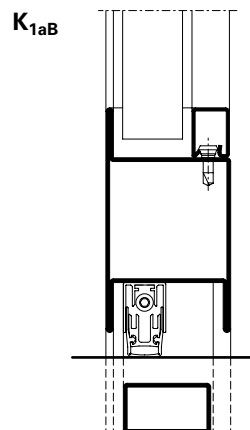
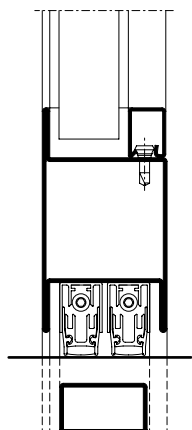

Schallschutz

Der aus der Tabelle A1 abzulesende Wert für die Schalldämmung $R_{w, Tür}$ beträgt:

Isolation phonique

La valeur à relever sur le tableau A1 concernant l'isolement contre les sons aériens $R_{w, Porte}$ est la suivante:

Sound insulation

The value taken from table A1 for the sound insulation $R_{w, Door}$ is:

$$R_{w, Tür} = R_w + K_S + K_{FV} + K_{Nass} + K_{1aB} + K_{W/S} + K_{Band} + K_{G 0,4} + K_{G 1,8} + K_{G 2,6} + K_{G 3,2} \text{ dB}$$

- R_w** bewertetes Schalldämm-Mass der Türe in Abhängigkeit von der Schalldämmung $R_{w,P, Glas}$
- $R_{w,P, Glas}$** bewertetes Schalldämm-Mass der Verglasung (Prüfwert nach ISO 140-3, mit Prüfnachweis einer PÜZ-Stelle). Alternativ können Tabellenwerte nach DIN EN 12758, Abschnitt 6 verwendet werden
- K_S** Korrekturwert für zweiflügelige Türen
- K_{FV}** Korrekturwert für Festverglasungen mit erhöhtem Scheibenanteil
- K_{Nass}** Korrekturwert für Nassverglasung
- K_{1aB}** Korrekturwert für Türen mit einer absenkbaren Bodendichtung
- K_{Band}** Korrekturwert bei Verwendung von Anschlagbändern, die eine Dichtungsebene unterbrechen ($K_{Band} = - 0,5 \text{ dB pro Band}$)
- $K_{W/S}$** Korrekturwert für Türen mit einer Anschlagsschwelle
- $K_{G 0,4}$** Korrekturwert für Einzelscheiben mit einer Glasfläche $\leq 0,4 \text{ m}^2$. Die Korrektur gilt auch für Konstruktionen mit glasteilenden Sprossen.
- $K_{G 1,8}$** Korrekturwert für Einzelscheiben mit einer Glasfläche $\geq 1,8 \text{ m}^2$
- $K_{G 2,6}$** Korrekturwert für Einzelscheiben mit einer Glasfläche $\geq 2,6 \text{ m}^2$
- $K_{G 3,2}$** Korrekturwert für Einzelscheiben mit einer Glasfläche $\geq 3,2 \text{ m}^2$

- R_w** Mesure d'isolement contre les sons aériens des portes évaluée suivant l'isolement phonique $R_{w,P, Glas}$
- $R_{w,P, Glas}$** Cote d'isolement acoustique du vitrage évalué (valeur contrôlée selon ISO 140-3 avec certificat d'un bureau de contrôle, de surveillance ou de certification). Il est également possible d'utiliser les valeurs selon le tableau DIN EN 12758, section 6
- K_S** Valeur de correction pour portes à deux vantaux
- K_{FV}** Valeur de correction pour vitrages fixes à fort pourcentage de vitre
- K_{Nass}** Valeur de correction pour vitrage avec mastic
- K_{1aB}** Valeur de correction pour portes avec un joint seuil automatique
- K_{Band}** Valeur corrective en cas d'utilisation de paumelles qui interrompent un plan d'étanchéité ($K_{Band} = - 0,5 \text{ dB par paumelle}$)
- $K_{W/S}$** Valeur de correction pour portes avec un seuil de butée
- $K_{G 0,4}$** Valeur de correction pour vitres individuelles avec une surface vitrée $\leq 0,4 \text{ m}^2$. La correction s'applique aussi aux constructions à meneaux séparant les vitres.
- $K_{G 1,8}$** Valeur de correction pour vitres individuelles avec surface vitrée $\geq 1,8 \text{ m}^2$
- $K_{G 2,6}$** Valeur de correction pour vitres individuelles avec surface vitrée $\geq 2,6 \text{ m}^2$
- $K_{G 3,2}$** Valeur de correction pour vitres individuelles avec surface vitrée $\geq 3,2 \text{ m}^2$

- R_w** Airborne sound reduction index of doors depending on the sound insulation $R_{w,P, Glas}$
- $R_{w,P, Glas}$** Airborne sound reduction index (test value in accordance with ISO 140-3, with a test certificate from a recognised testing, inspection or certification body). Alternatively, the tabulated values in DIN EN 12758, Section 6 may be used
- K_S** Correction value for double-leaf doors
- K_{FV}** Correction value for fixed glazing with increased proportion of pane
- K_{Nass}** Correction value for glazing with sealing
- K_{1aB}** Correction value for doors with a threshold gasket that can be lowered
- K_{Band}** Correction value when using hinges that interrupt a sealing plane ($K_{Band} = - 0.5 \text{ dB per hinge}$)
- $K_{W/S}$** Correction value for doors with a rebate threshold
- $K_{G 0,4}$** Correction value for single panes with a glass area $\leq 0,4 \text{ m}^2$. The correction also applies to buildings with glazing bars
- $K_{G 1,8}$** Correction value for single panes with a glass area $\geq 1,8 \text{ m}^2$
- $K_{G 2,6}$** Correction value for single panes with a glass area $\geq 2,6 \text{ m}^2$
- $K_{G 3,2}$** Correction value for single panes with a glass area $\geq 3,2 \text{ m}^2$

