

## Jansen-Economy 50 RS (Smoke)

Rauchschutztüren nach DIN 18095 (EN 1634-3) aus Stahl und Edelstahl

## Jansen-Economy 50 RS (Smoke)

Portes coupe-fumée selon DIN 18095 (EN 1634-3) en acier et acier Inox

## Jansen-Economy 50 RS (Smoke)

Smoke control doors according to DIN 18095 (EN 1634-3) in steel and stainless steel



---

**Systemübersicht**

Merkmale  
Zulassungen  
Systemausführungen  
Typenübersicht

**Sommaire du système**

Caractéristiques  
Homologations  
Exécutions de système  
Sommaire des types

**Summary of system**

Characteristics  
Authorisations  
System versions  
Summary of types

**2**

---

**Profilsortiment in Stahl  
und Edelstahl****Assortiment de profilé  
en acier et acier inox****Range of profiles in  
steel and stainless steel****12**

---

**Beispiele**

Schnittpunkte  
Konstruktionsdetails  
Anschlüsse am Bau

**Exemples**

Coupes de détails  
Détails de construction  
Raccords au mur

**Examples**

Section details  
Construction details  
Attachment to structure

**18**

---

**Leistungseigenschaften****Caractéristiques de  
performance****Performance  
characteristics****29**

Alle Ausführungen dieser Dokumentation haben wir sorgfältig und nach bestem Wissen zusammengestellt. Wir können aber keine Verantwortung für die Benutzung der vermittelten Vorschläge und Daten übernehmen. Wir behalten uns technische Änderungen ohne Vorankündigung vor.  
Aktuelle Version auf [www.jansen.com](http://www.jansen.com)







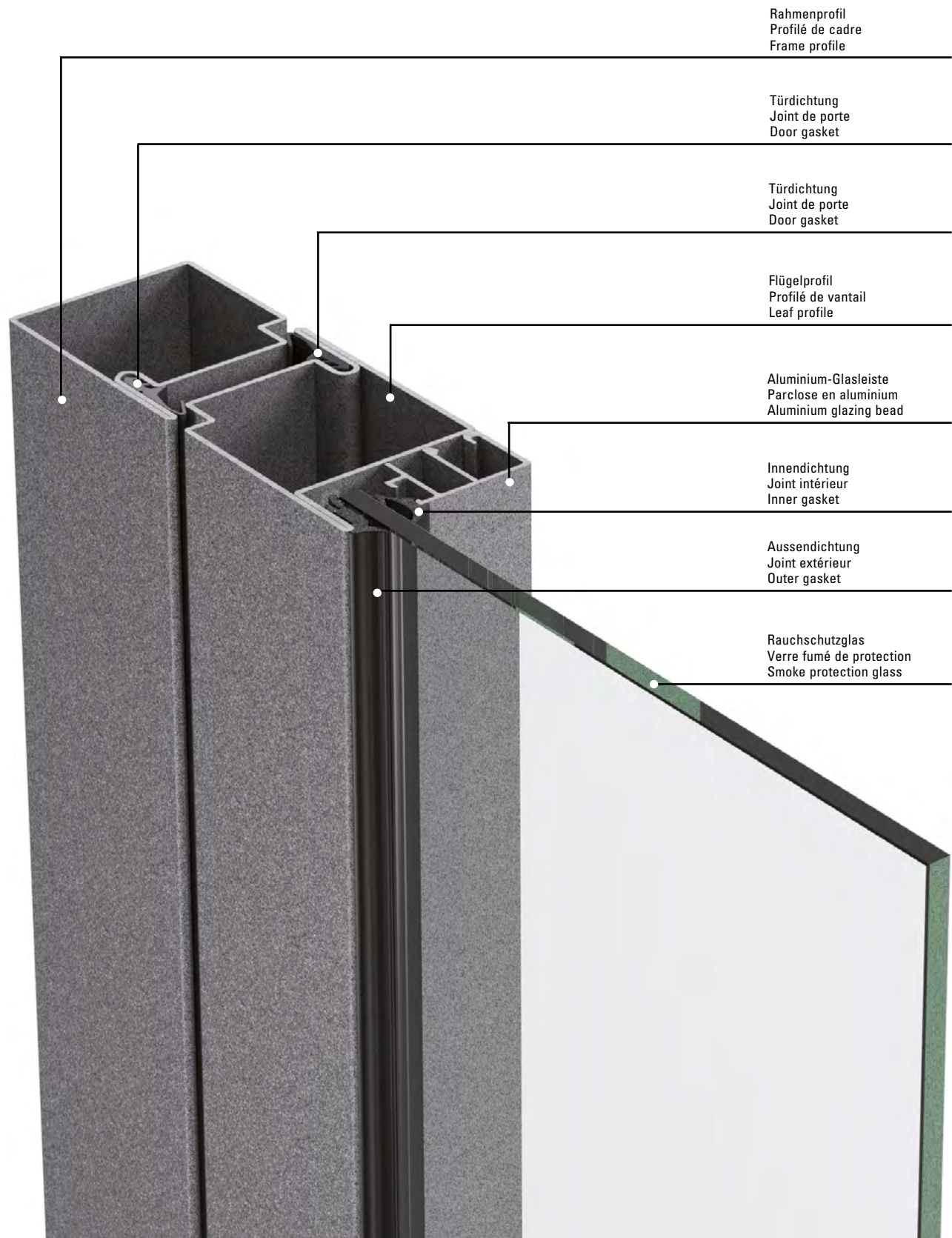

Nous avons apporté le plus grand soin à l'élaboration de cette documentation. Cependant, nous déclinons toute responsabilité pour l'utilisation faite de nos propositions et de nos données.  
Nous nous réservons le droit de procéder à des modifications techniques sans préavis.  
Version actuelle sur [www.jansen.com](http://www.jansen.com)



All the information contained in this documentation is given to the best of our knowledge and ability. However, we decline all responsibility for the use made of these suggestions and data.  
We reserve the right to effect technical modifications without prior warning.  
Current version available at [www.jansen.com](http://www.jansen.com)







Norm	Eigenschaft Caractéristique Characteristic	Klassifizierung/Wert Classification / Valeur Classification / Value										
		npd	1 (400)	2 (800)	3 (1200)	4 (1600)	5 (2000)	Exxx (>2000)				
 EN 12210	<b>Widerstandsfähigkeit bei Windlast</b> <b>Résistance à la pression du vent</b> <b>Resistance to wind load</b>	npd	1 (400)	2 (800)	3 (1200)	4 (1600)	5 (2000)	Exxx (>2000)				
 EN 12208	<b>Schlagregendichtheit</b> <b>Etanchéité à la pluie battante</b> <b>Watertightness</b>	npd	1A (0)	2A (50)	3A (100)	4A (150)	5A (200)	6A (250)	7A (300)	8A (450)	9A (600)	Exxx (>750)
 EN ISO 10140	<b>Schalldämmung</b> $R_w$ (C, $C_{tr}$ ) (dB) <b>Isolation phonique</b> $R_w$ (C, $C_{tr}$ ) (dB) <b>Sound insulation</b> $R_w$ (C, $C_{tr}$ ) (dB)	npd	bis $R_w$ 44 dB (-2; -5) jusqu'à $R_w$ 44 dB (-2; -5) up to $R_w$ 44 dB (-2; -5)									
 EN ISO 10077-2	<b>Wärmedurchgangskoeffizient</b> $U_f$ (W/(m <sup>2</sup> ·K)) <b>Transmission thermique</b> $U_f$ (W/(m <sup>2</sup> ·K)) <b>Thermal production</b> $U_f$ (W/(m <sup>2</sup> ·K))	npd	ab 5.65 W/m <sup>2</sup> K à partir de 5.65 W/m <sup>2</sup> K from 5.65 W/m <sup>2</sup> K									
 EN 12207	<b>Luftdurchlässigkeit</b> <b>Perméabilité à l'air</b> <b>Air permeability</b>	npd	1 (150)		2 (300)		3 (600)		4 (600)			
 EN 1192	<b>Klassifizierung der Festigkeitsanforderungen</b> <b>Classification des exigences de résistance méc.</b> <b>Classification of strength requirements</b>	npd	1		2		3		4			
 EN 1522	<b>Durchschusshemmung</b> <b>Résistance aux balles</b> <b>Bullet proofing</b>	npd	FB1	FB2	FB3	FB4	FB5	FB6	FB7	FSG		
 EN 1191 EN 1603	<b>Dauerfunktionsprüfung</b> <b>Durabilité mécanique</b> <b>Mechanical durability</b>	D	1 5'000	2 10'000	3 20'000	4 50'000	5 100'000	6 200'000	7 500'000	8 1'000'000		
 EN 179 EN 1125	<b>Fähigkeit zur Freigabe</b> <b>Capacité au déclenchement</b> <b>Ability to release</b>		Anforderung erfüllt Exigence remplie Requirement fulfilled									

Norm	Eigenschaft Caractéristique Characteristic	Klassifizierung/Wert Classification / Valeur Classification / Value
 EN 1634-3 DIN 18095	<b>Rauchschutz</b> <b>Etanchéité à la fumée</b> <b>Smoke control</b>	S <sub>a</sub> / S <sub>200</sub>
 EN 16034 EN 13501-2	<b>Selbstschliessung</b> <b>Fermeture automatique</b> <b>Self-closing</b>	C
 EN 16034	<b>Dauerhaftigkeit der Selbstschliessung                      gegenüber Alterung (Korrosion)</b> <b>Endurance de la fermeture automatique                      contre le vieillissement (corrosion)</b> <b>Durability of self-closing against ageing                      (corrosion)</b>	erzielt atteinte achieved



### **Fluchttürsysteme**

- Fluchttürsysteme geeignet für Notausgänge und Paniktüren
- Fluchttürnorm EN 179 für Notausgangsverschlüsse erfüllt
- Fluchttürnorm EN 1125 für Panikverschlüsse erfüllt

### **Systèmes de porte de secours**

- Systèmes de porte de secours pour issues de secours et portes panique
- Norme relative aux portes de secours EN 179, remplie pour les fermetures d'issue de secours
- Norme relative aux portes de secours EN 1125, remplie pour les fermetures panique

### **Emergency exit systems**

- Emergency exit systems suitable for emergency exits and panic doors
- Emergency exit standard EN 179 for emergency exit devices fulfilled
- Emergency exit standard EN 1125 for panic exit devices fulfilled



### **Jansen-Economy 50 RS Edelstahl**

- Werkstoff 1.4307 und 1.4404
- Für ein- und zweiflüglige Brandschutztüren mit oder ohne Seitenteile bzw. Oberlicht
- Für Brandschutztrennwände
- Für Aussenanwendungen
- Schlanke Rahmen und Türprofile mit nur 50 mm Bautiefe

### **Jansen-Economy 50 RS acier Inox**

- Matériaux 1.4307 et 1.4404
- Pour portes coupe-feu à un/deux vantaux avec ou sans pièces latérales ou imposte
- Pour cloisons coupe-feu
- Pour l'extérieur
- Cadres et profilés de porte fins avec une profondeur de montage de seulement 50 mm

### **Jansen-Economy 50 RS stainless steel**

- Material 1.4307 and 1.4404
- For single and double-leaf fire doors with or without sidelight/toplight
- For fire wallse
- For external usen
- Narrow frames and door profiles with just 50 mm basic depth

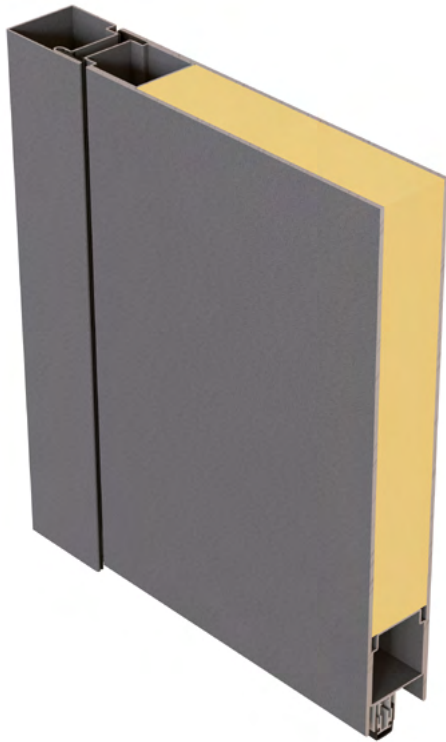

### **Verblechte Jansen-Economy 50 RS Türen**

- Für ein- und zweiflügelige Brandschutztüren mit oder ohne Seitenteile resp. Oberlichter
- Flächenbündig verblechte Türen
- Bleche können an den Rahmen geschweisst oder geklebt werden
- Mit oder ohne Glasausschnitte möglich

### **Portes tôlées Jansen-Economy 50 RS**

- Pour des portes coupe-feu à un/deux vantaux avec ou sans pièces latérales ou impostes
- Portes tôlées à fleur
- Les tôles peuvent être soudées ou collées sur le cadre
- Possibles avec ou sans panneaux de verre

### **Jansen Economy 50 RS sheet metal doors**

- For single and double-leaf fire doors with or without sidelights or toplights
- Flush-fitted sheet metal doors
- Sheet metal can be welded or bonded to the frame
- Possible with or without glass vision panels

## Jansen Docu Center

Die Plattform zum effizienten Arbeiten mit Jansen Dokumentationen. Im Jansen Docu Center stehen alle Produktinformationen jederzeit digital in der aktuellsten Version zur Verfügung: von Architekten-Informationen über Bestell- und Fertigungskatalogen bis hin zu Anleitungen und Prospekten sowie Videos.

Die Inhalte können einfach und schnell aufgerufen werden. Ein für den Anwender komfortables papierloses Arbeiten, das zahlreiche Vorteile bietet.

## Download CAD Daten

**DXF**

**DWG**

Sie können die Zeichnungen in den Formaten DXF und/oder DWG herunterladen. Klicken Sie auf das entsprechende Icon und der Download erfolgt.

Die Hinweise «Artikelbibliothek/Türbeschläge/Fensterbeschläge» bedeuten, dass Sie mit einem Klick die gesamte Artikelbibliothek des entsprechenden Systems herunterladen (Profile, Beschläge, Glasleisten, Zubehör etc.).

## Info und Beratung

Gerne beraten wir Sie persönlich und stehen Ihnen bei Fragen zur Verfügung. Bitte schreiben Sie uns Ihre Anliegen an: [info@jansen.com](mailto:info@jansen.com)

## Jansen Docu Center

La plate-forme pour travailler efficacement avec les documentations Jansen. Le Jansen Docu Center met à votre disposition les informations sur les produits, en format numérique et dans une version actualisée: des catalogues de commande et de fabrication aux instructions et prospectus, en passant par les informations destinées aux architectes et vidéos.

Les contenus sont facilement et rapidement accessibles. Une manière de travailler confortable et offrant de nombreux avantages.

## Télécharger fichiers DAO

**DXF**

**DWG**

Vous pouvez télécharger les dessins aux formats DXF et/ou DWG. Cliquez sur l'icône correspondante et le téléchargement s'effectuera.

Les indications «Bibliothèque des articles/Ferures de porte/Ferrures de fenêtres» signifie que vous téléchargez la totalité de la bibliothèque des articles du système donné (profilés, ferrures, parcloles, accessoires etc.).

## Info et conseils

Nous vous conseillons volontiers individuellement et sommes à votre disposition si vous avez des questions à poser. Veuillez nous envoyer votre requête à: [info@jansen.com](mailto:info@jansen.com)

## Jansen Docu Center

The platform for working efficiently with Jansen documentation. The latest version of all the product information is available digitally at any time in the Jansen Docu Center – from order and fabrication manuals to architect information, instructions and brochures and videos.

The content can be retrieved quickly and easily. The user can work conveniently without paper, which has numerous benefits.

## Download CAD files

**DXF**

**DWG**

You can download the drawings in DXF and/or DWG format. Click on the relevant icon to begin the download.

The items «Article library/Door fittings/Window fittings» means that you download the entire article library for the corresponding system with one click (profiles, fittings, glazing beads, accessories etc.).

## Information and advice

We would be delighted to provide you with advice in person and are available to answer any questions you may have. Please write to us with your queries at: [info@jansen.com](mailto:info@jansen.com)

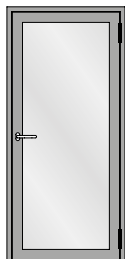

Einflügelige Türe  
Porte à un vantail  
Single leaf door

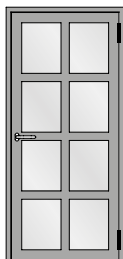

Einflügelige Türe mit Riegel  
Porte à un vantail avec traverse  
Single leaf door with transom

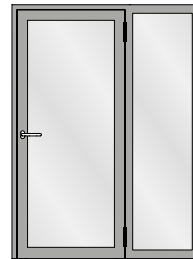

Einflügelige Türe mit festem Seitenteil  
Porte à un vantail avec partie latérale fixe  
Single leaf door with fixed side light

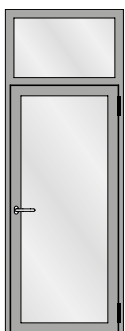

Einflügelige Türe mit festem Oberlicht  
Porte à un vantail avec imposte fixe  
Single leaf door with fixed top light

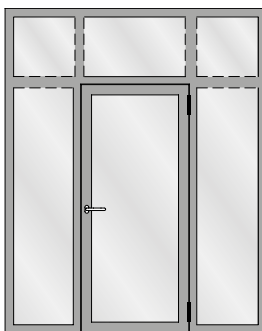

Einflügelige Türe mit zwei festen Seitenteilen  
und festem Oberlicht  
Porte à un vantail avec deux parties latérale fixe  
et imposte fixe  
Single leaf door with two fixed side light and  
fixed top light

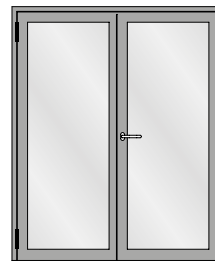

Zweiflügelige Türe  
Porte à deux vantaux  
Double leaf door



Zweiflügelige Türe mit zwei festen Seitenteilen  
Porte à deux vantaux avec deux parties  
latérales fixes  
Double leaf door with two fixed side lights

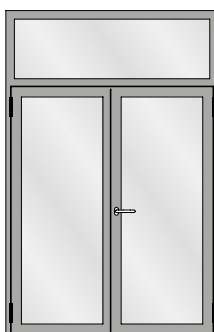

Zweiflügelige Türe mit festem Oberlicht  
Porte à deux vantaux avec imposte fixe  
Double leaf door with fixed top light

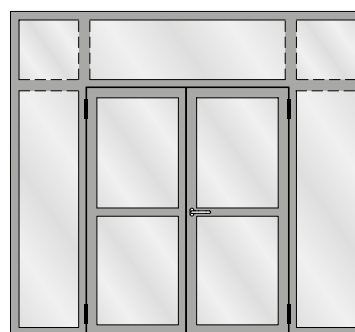

Zweiflügelige Türe mit zwei festen Seitenteilen  
und festen Oberlichtern  
Porte à deux vantaux avec deux parties latérales  
fixes et impostes fixes  
Double leaf door with two fixed side lights and  
fixed top lights



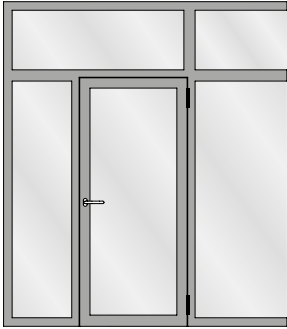

Festverglasung mit einflügeliger Türe  
Vitrage fixe avec porte à un vantail  
Fixed glazing with single leaf door

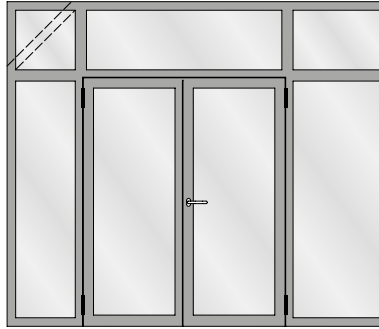

Festverglasung mit zweiflügeliger Türe  
Vitrage fixe avec porte à deux vantaux  
Fixed glazing with double leaf door

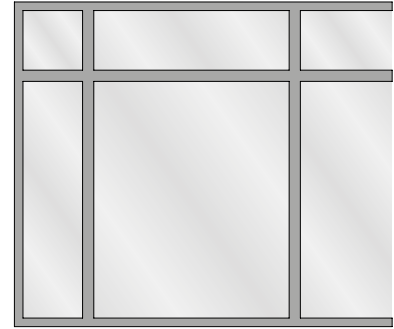

Festverglasung  
Vitrage fixe  
Fixed glazing

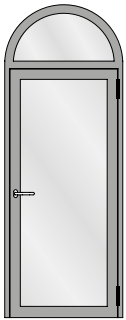

Einflügelige Türe mit Rundbogen-Oberlicht  
Porte à un vantail avec imposte demi-ronde  
Single leaf door with round arched top light

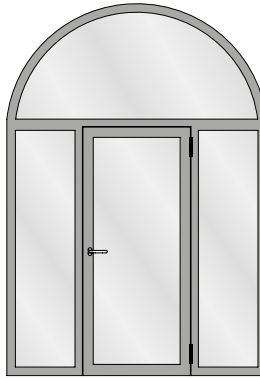

Einflügelige Türe mit zwei festen Seitenteilen  
und Rundbogen-Oberlicht  
Porte à un vantail avec deux parties latérales  
fixes et imposte demi-ronde  
Single leaf door with two fixed side lights and  
round arched top light

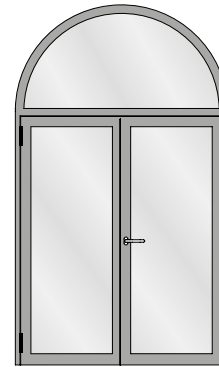

Zweiflügelige Türe mit Rundbogen-Oberlicht  
Porte à deux vantaux avec imposte demi-ronde  
Double leaf door with round arched top light

**Für Festverglasungen gelten  
nationale Zulassungen.**

**Les homologations nationales  
s'appliquent aux vitrages fixes.**

**National approvals apply to fixed  
glazing.**



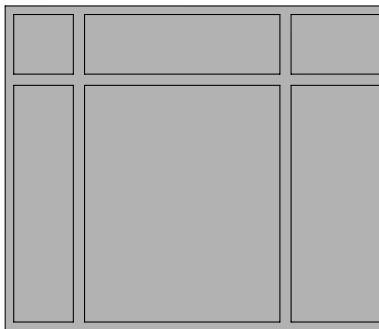
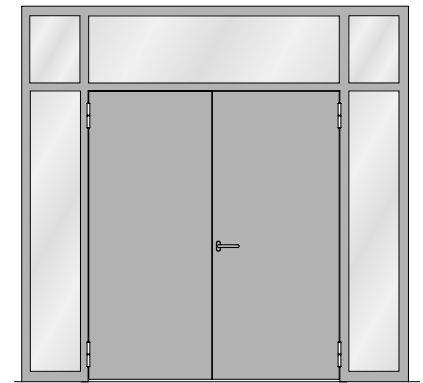
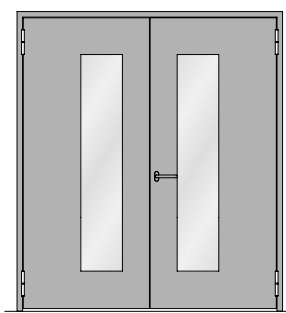
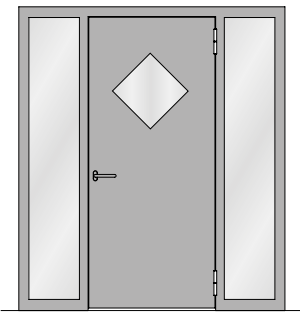
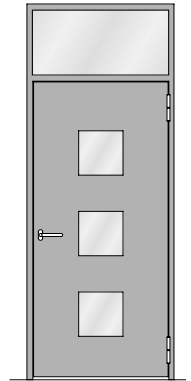
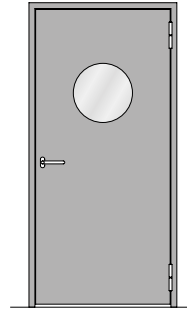
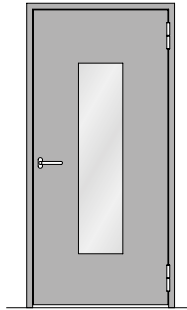
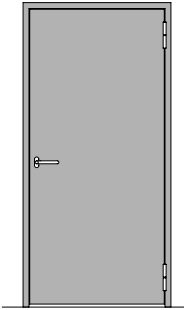

**Für Festverglasungen gelten nationale Zulassungen.**

**Les homologations nationales s'appliquent aux vitrages fixes.**

**National approvals apply to fixed glazing.**

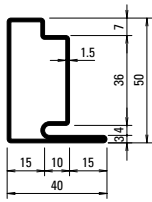

**30.006**  
**30.006 Z**  
 30.006.01\*  
 30.006.05\*

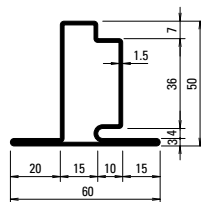

**30.106**  
**30.106 Z**

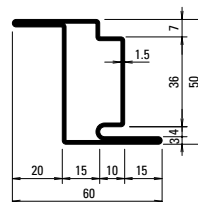

**30.406**  
**30.406 Z**

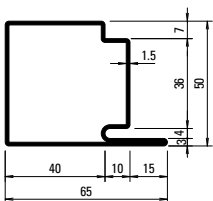

**30.007**  
**30.007 Z**  
 30.007.01  
 30.007.05

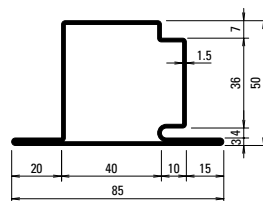

**30.107**  
**30.107 Z**  
 30.107.01  
 30.107.05

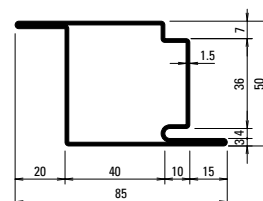

**30.407**  
**30.407 Z**  
 30.407.01  
 30.407.05

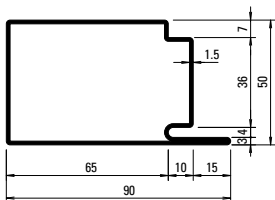

**30.008**  
**30.008 Z**

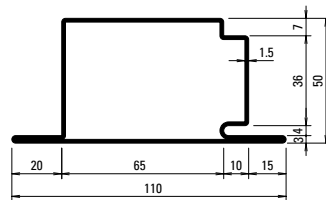

**30.108**  
**30.108 Z**

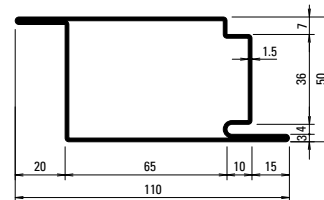

**30.408**  
**30.408 Z**

Gewichte für die Edelstahl-Profile siehe Seite 15  
 Poids pour profilés en acier Inox voir page 15  
 Weights for stainless steel profiles see page 15

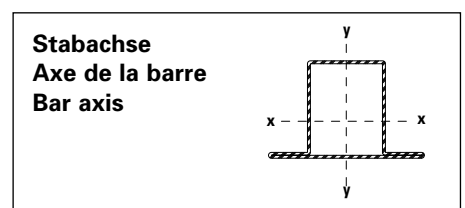

Profil-Nr.	G kg/m	F cm <sup>2</sup>	I <sub>x</sub> cm <sup>4</sup>	W <sub>x</sub> cm <sup>3</sup>	I <sub>y</sub> cm <sup>4</sup>	W <sub>y</sub> cm <sup>3</sup>	U m <sup>2</sup> /m
<b>30.006</b>	2,330	2,97	9,31	3,00	3,96	1,62	0,190
<b>30.106</b>	2,830	3,60	10,87	3,19	7,52	2,41	0,230
<b>30.406</b>	2,830	3,60	13,79	5,31	7,52	2,41	0,230
<b>30.007</b>	2,960	3,77	14,23	4,78	16,30	4,64	0,240
<b>30.107</b>	3,450	4,40	16,09	4,97	24,97	5,64	0,280
<b>30.407</b>	3,450	4,40	18,48	7,16	24,97	5,64	0,280

Profil-Nr.	G kg/m	F cm <sup>2</sup>	I <sub>x</sub> cm <sup>4</sup>	W <sub>x</sub> cm <sup>3</sup>	I <sub>y</sub> cm <sup>4</sup>	W <sub>y</sub> cm <sup>3</sup>	U m <sup>2</sup> /m
<b>30.008</b>	3,590	4,57	19,06	6,59	40,34	8,68	0,290
<b>30.108</b>	4,080	5,20	21,15	6,76	56,20	9,84	0,330
<b>30.408</b>	4,080	5,20	23,17	9,02	56,20	9,84	0,330

**Profilübersicht**  
**Sommaire des profilés**  
**Summary of profiles**

Jansen-Economy 50 RS DIN 18095  
 Jansen-Economy 50 RS DIN 18095  
 Jansen-Economy 50 RS DIN 18095

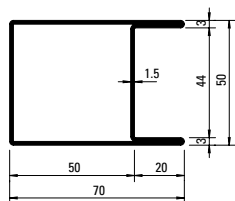

**04.568**  
**04.568 Z**

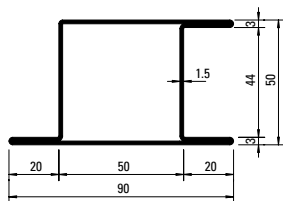

**05.568**  
**05.568 Z**  
 05.568.01  
 05.568.05

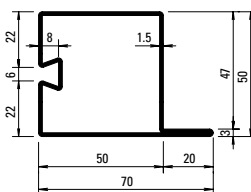

**32.388**  
**32.388 Z**

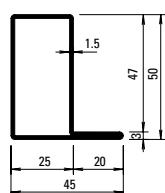

**01.534**  
**01.534 Z**  
 01.534.01  
 01.534.05

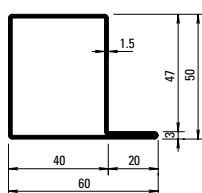

**01.564**  
**01.564 Z**  
 01.564.01  
 01.564.05

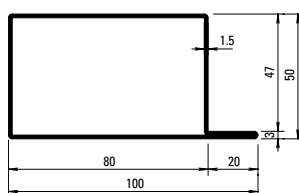

**01.592**  
**01.592 Z**

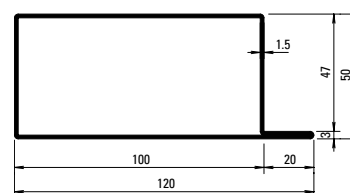

**01.596**  
**01.596 Z**

Gewichte für die Edelstahl-Profile  
 siehe Seite 15

Poids pour profilés en acier Inox  
 voir page 15

Weights for stainless steel profiles  
 see page 15

**Oberfläche/Werkstoff**

Artikel-Nr.

**ohne Zusatz** = blank

**mit Z** = bandverzinkter Stahl

**Werkstoff 1.4404 (AISI 316L)**

mit 01 = blank

mit 03 = geschliffen, Korn 220-240

**Werkstoff 1.4307 (AISI 304L)**

mit 05 = blank

mit 07 = geschliffen, Korn 220-240

Edelstahl geschliffen auf Anfrage

**Surface/Matériau**

No. d'article

**sans supplément** = brut

**avec Z** = bande d'acier zinguée

**Matériau 1.4404 (AISI 316L)**

avec 01 = brut

avec 03 = polies, grain 220-240

**Matériau 1.4307 (AISI 304L)**

avec 05 = brut

avec 07 = polies, grain 220-240

Acier Inox polie sur demande

**Surface/Material**

Part no.

**without addition** = bright

**with Z** = strip galvanised steel

**Material 1.4404 (AISI 316L)**

with 01 = bright

with 03 = polished, grain 220-240

**Material 1.4307 (AISI 304L)**

with 05 = bright

with 07 = polished, grain 220-240

Stainless steel polished on request

Profil-Nr.	G kg/m	F cm <sup>2</sup>	I <sub>x</sub> cm <sup>4</sup>	W <sub>x</sub> cm <sup>3</sup>	I <sub>y</sub> cm <sup>4</sup>	W <sub>y</sub> cm <sup>3</sup>	U m <sup>2</sup> /m
<b>01.534</b>	2,130	2,71	9,35	3,11	4,78	1,73	0,185
<b>01.564</b>	2,490	3,17	12,10	4,12	11,20	3,25	0,216
<b>01.592</b>	3,430	4,37	19,35	6,86	46,90	8,80	0,296
<b>01.596</b>	3,900	4,97	22,93	8,25	77,23	12,30	0,336

Profil-Nr.	G kg/m	F cm <sup>2</sup>	I <sub>x</sub> cm <sup>4</sup>	W <sub>x</sub> cm <sup>3</sup>	I <sub>y</sub> cm <sup>4</sup>	W <sub>y</sub> cm <sup>3</sup>	U m <sup>2</sup> /m
<b>04.568</b>	3,190	4,06	17,76	7,11	21,77	6,20	0,275
<b>05.568</b>	3,620	4,65	20,62	7,37	32,39	6,55	0,315
<b>32.388</b>	2,940	3,74	14,10	4,89	18,50	4,56	0,254

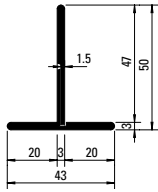

**400.023**  
**400.023 Z**

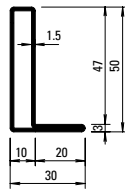

**01.531**  
**01.531 Z**

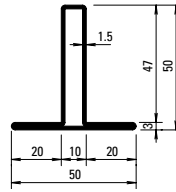

**02.531**  
**02.531 Z**

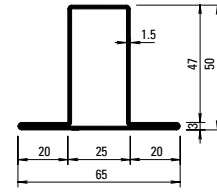

**02.534**  
**02.534 Z**  
**02.534.01**  
**02.534.05**

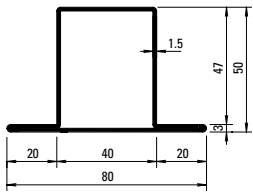

**02.564**  
**02.564 Z**  
**02.564.01\***  
**02.564.05\***

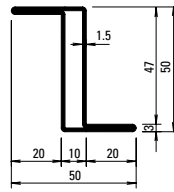

**03.531**  
**03.531 Z**

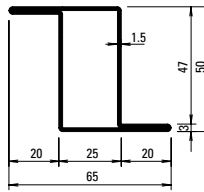

**03.534**  
**03.534 Z**

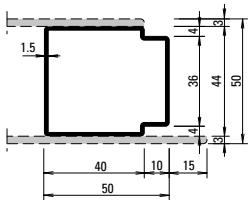

**81.009**  
**81.009 Z**

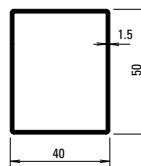

**400.048**  
**400.048 Z**

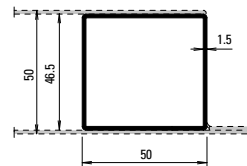

**400.049**  
**400.049 Z**

Profil-Nr.	G kg/m	F cm <sup>2</sup>	I <sub>x</sub> cm <sup>4</sup>	W <sub>x</sub> cm <sup>3</sup>	I <sub>y</sub> cm <sup>4</sup>	W <sub>y</sub> cm <sup>3</sup>	U m <sup>2</sup> /m
<b>01.531</b>	1,770	2,26	6,55	2,11	1,42	0,67	0,155
<b>02.531</b>	2,240	2,86	8,00	2,31	3,26	1,30	0,195
<b>02.534</b>	2,590	3,30	10,99	3,30	8,56	2,63	0,224
<b>03.531</b>	2,240	2,85	10,63	4,25	3,25	1,30	0,194
<b>02.564</b>	2,950	3,75	13,90	4,31	17,60	4,40	0,255
<b>03.534</b>	2,590	3,30	13,28	5,13	8,56	2,63	0,224
<b>81.009</b>	2,090	2,67	7,79	3,54	9,63	3,76	0,182
<b>400.023</b>	2,060	2,62	6,63	1,87	1,91	0,88	0,182
<b>400.048</b>	2,050	2,58	9,46	3,78	6,70	3,35	0,177
<b>400.049</b>	2,200	2,77	10,61	4,24	9,49	4,08	0,190

**Stabachse**  
**Axe de la barre**  
**Bar axis**

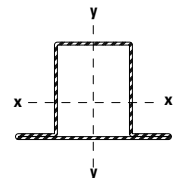

Artikelbibliothek  
 Bibliothèque des articles  
 Article library

**DXF** **DWG**

**Profilübersicht**  
**Sommaire des profilés**  
**Summary of profiles**

Jansen-Economy 50 RS DIN 18095  
Jansen-Economy 50 RS DIN 18095  
Jansen-Economy 50 RS DIN 18095

**Oberfläche/Werkstoff**

Artikel-Nr.

**ohne Zusatz** = blank

**mit Z** = bandverzinkter Stahl

**Werkstoff 1.4404 (AISI 316L)**

mit 01 = blank

mit 03 = geschliffen, Korn 220-240

**Werkstoff 1.4307 (AISI 304L)**

mit 05 = blank

mit 07 = geschliffen, Korn 220-240

Edelstahl geschliffen auf Anfrage

**Surface/Matériau**

No. d'article

**sans supplément** = brut

**avec Z** = bande d'acier zinguée

**Matériau 1.4404 (AISI 316L)**

avec 01 = brut

avec 03 = polies, grain 220-240

**Matériau 1.4307 (AISI 304L)**

avec 05 = brut

avec 07 = polies, grain 220-240

Acier Inox polie sur demande

**Surface/Material**

Part no.

**without addition** = bright

**with Z** = strip galvanised steel

**Material 1.4404 (AISI 316L)**

with 01 = bright

with 03 = polished, grain 220-240

**Material 1.4307 (AISI 304L)**

with 05 = bright

with 07 = polished, grain 220-240

Stainless steel polished on request

**Gewichte für Edelstahl-Profile**

.01 = Werkstoff 1.4404 (AISI 316L)

.05 = Werkstoff 1.4307 (AISI 304L)

30.006.01 = 2,232 kg/m

30.007.01 = 2,832 kg/m

30.107.01 = 3,288 kg/m

30.407.01 = 3,288 kg/m

01.534.01 = 2,153 kg/m

02.534.01 = 2,622 kg/m

01.564.01 = 2,513 kg/m

02.564.01 = 2,975 kg/m

05.568.01 = 3,672 kg/m

**Poids pour profilés en acier Inox**

.01 = matériau 1.4404 (AISI 316L)

.05 = matériau 1.4307 (AISI 304L)

30.006.05 = 2,204 kg/m

30.007.05 = 2,797 kg/m

30.107.05 = 3,247 kg/m

30.407.05 = 3,247 kg/m

01.534.05 = 2,126 kg/m

02.534.05 = 2,589 kg/m

01.564.05 = 2,481 kg/m

02.564.05 = 2,938 kg/m

05.568.05 = 3,626 kg/m

**Weights for stainless steel profiles**

.01 = material 1.4404 (AISI 316L)

.05 = material 1.4307 (AISI 304L)

**Bogentüren**  
**Portes cintrées**  
**Arched doors**

Jansen-Economy 50 RS DIN 18095  
 Jansen-Economy 50 RS DIN 18095  
 Jansen-Economy 50 RS DIN 18095

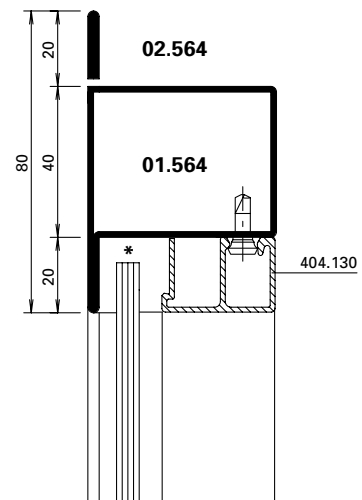
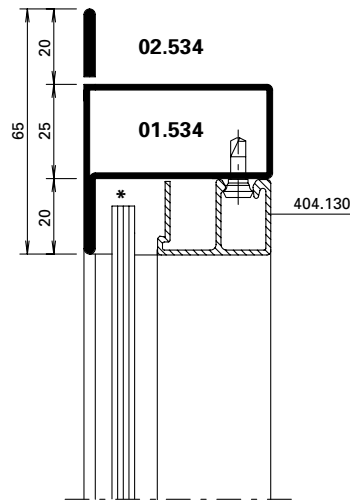
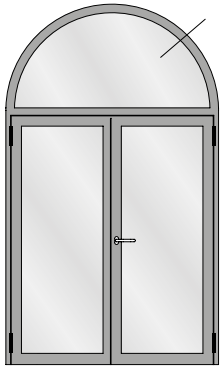

\* Füllelemente mit rauchdichtem dauerelastischem Dichtstoff (z.B. 450.092) vollständig in den Glasfalzgrund einkleben.

\* Coller entièrement les éléments de remplissage avec produit d'étanchéité à l'élasticité permanente (p.ex. 450.092) dans la feuillure en verre.

\* Infill panels with smoke-tight, permanently flexible sealant (e.g. 450.092) fully glued into the glazing rebate platform.

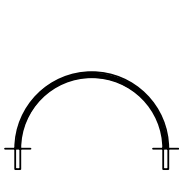

Halbrundbogen  
 Arc semi-circulaire  
 Semi-circular arch

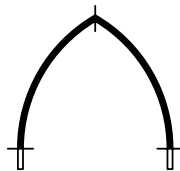

Spitzbogen  
 Arc en ogive  
 Gothic arch



Stichbogen  
 Arc bombé  
 Segmented arch



Korbbogen  
 Anse de panier  
 Oval arch

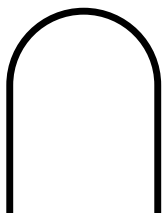

Halbrundbogen mit Schenkel  
 Arc surhaussé prolongée  
 Semi-circular arch with side extension

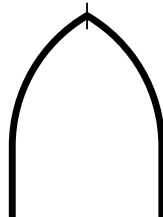

Spitzbogen mit Schenkel  
 Arc en ogive prolongée  
 Gothic arch with side extension

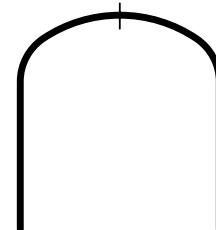



Korbbogen mit Schenkel  
 Anse de panier prolongée  
 Oval arch with side extension

**Bogentüren**  
**Portes cintrées**  
**Arched doors**

Jansen-Economy 50 RS DIN 18095  
 Jansen-Economy 50 RS DIN 18095  
 Jansen-Economy 50 RS DIN 18095

Profil Profilé Profile	Min. Radius Rayon min. Min. radius R	
------------------------------	---	--

	blank brut bright	verzinkt zinguée galvanised
	mm	mm
01.531	350	
01.534	400	800
01.564	650	1050
01.592	1100	

		
02.531	350	600
02.534	400	800
02.564	650	1050
400.023		800

		
03.531	600	
03.534	500	800

	
04.568	850

		
05.568	850	1250

		
400.048	550	650
400.049	550	850

Stahl-Glasleisten Parcloses en acier Steel glazing beads	Min. Radius Rayon min. Min. radius R
--	---

	
402.112 Z	500 mm
402.115 Z	500 mm
402.120 Z	600 mm
402.125 Z	750 mm
402.130 Z	1000 mm
402.135 Z	1500 mm

Stahl-Glasleisten Parcloses en acier Steel glazing beads	Min. Radius Rayon min. Min. radius R
--	---

	
62.507 Z	300 mm
62.508 Z	300 mm
62.509 Z	300 mm

Aluminium-Glasleisten Parcloses en aluminium Aluminium glazing beads	Min. Radius Rayon min. Min. radius R
--	---

	
404.112	400 mm
404.115	400 mm
404.120	400 mm
404.125	450 mm
404.130	500 mm
404.135	600 mm

	
405.115	500 mm
405.120	500 mm
405.125	800 mm
405.130	1000 mm
406.903	500 mm
406.905	500 mm
406.907	500 mm
406.909	600 mm

**Biegen von Edelstahl-Profilen auf Anfrage!**

Die Radien-Angaben beziehen sich auf die langjährige Erfahrung und Fertigung im Hause Jansen.

**Profilés acier Inox sur demande!**

Les rayons indiqués se fondent sur la longue expérience et la fabrication au sein de la maison Jansen.

**Stainless steel profiles on request!**

The radii specifications are based on the many years of experience Jansen has in fabrication.

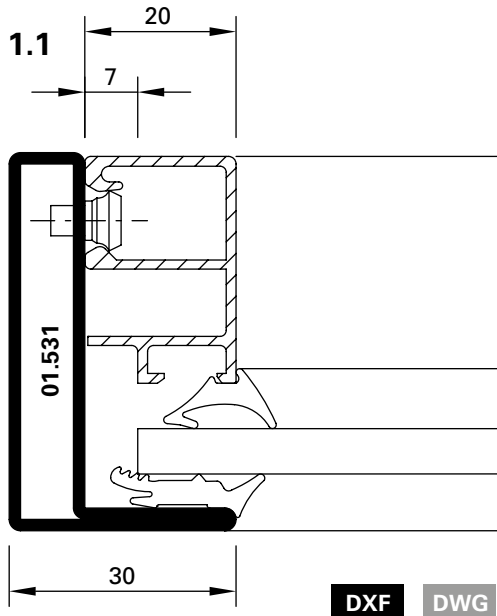
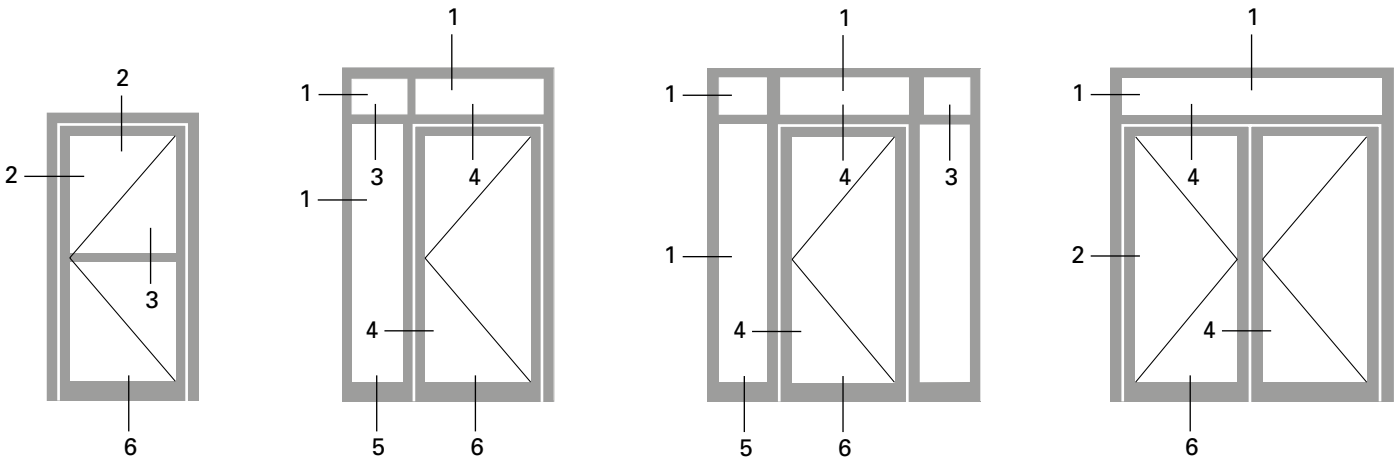

41-0101-C-001

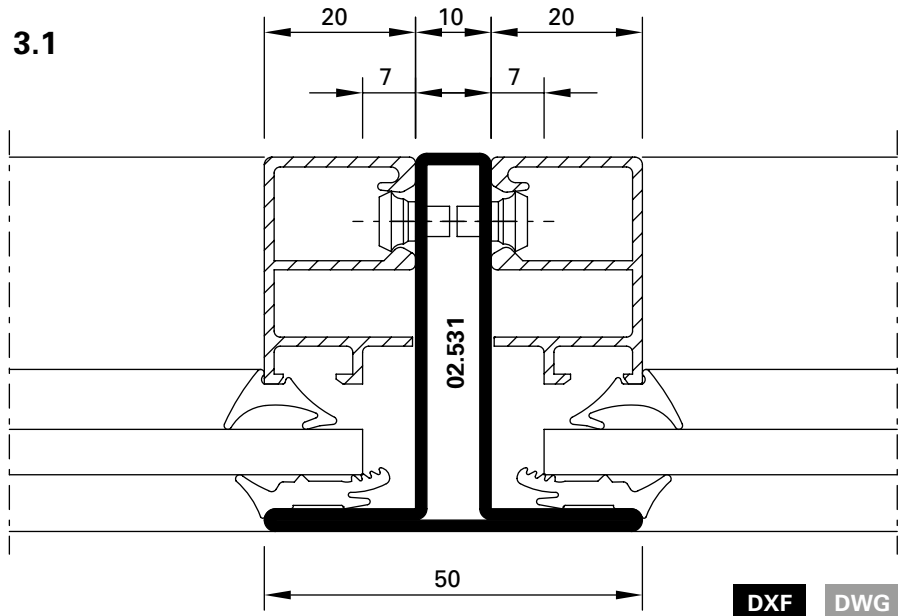

41-0101-C-002

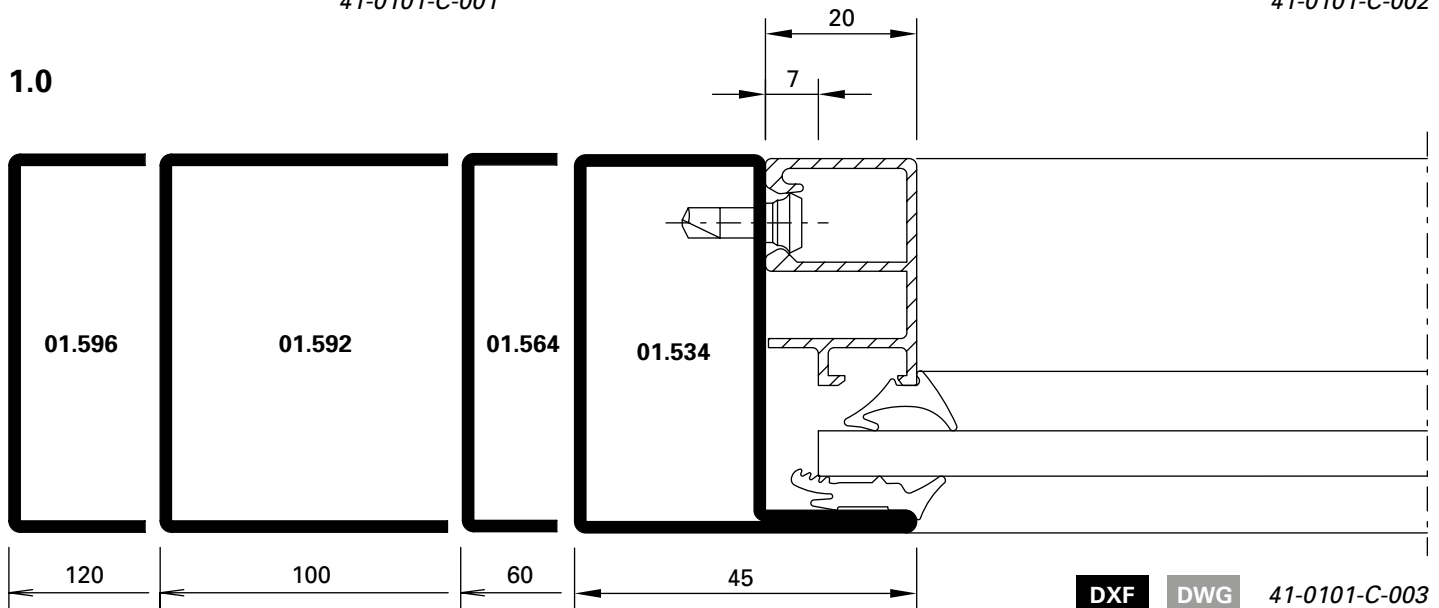

41-0101-C-003



2.0

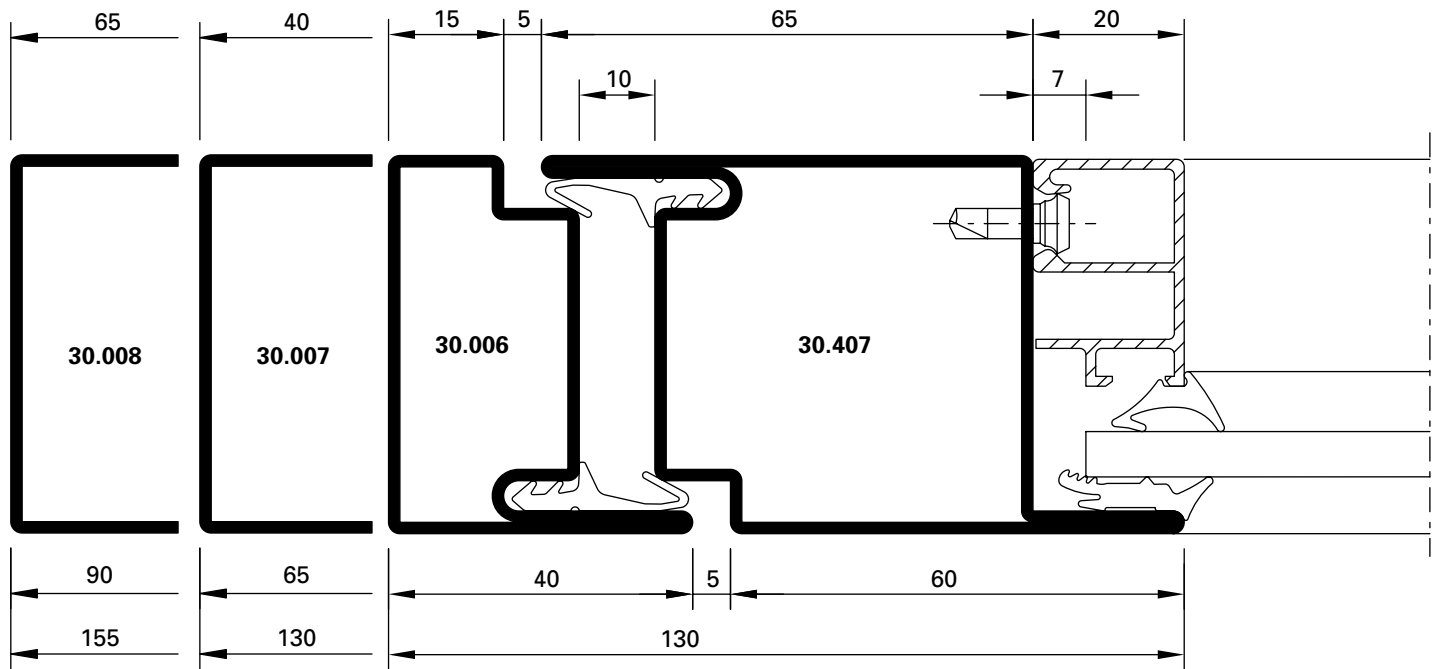

**DXF** **DWG** 41-0101-C-004

2.1

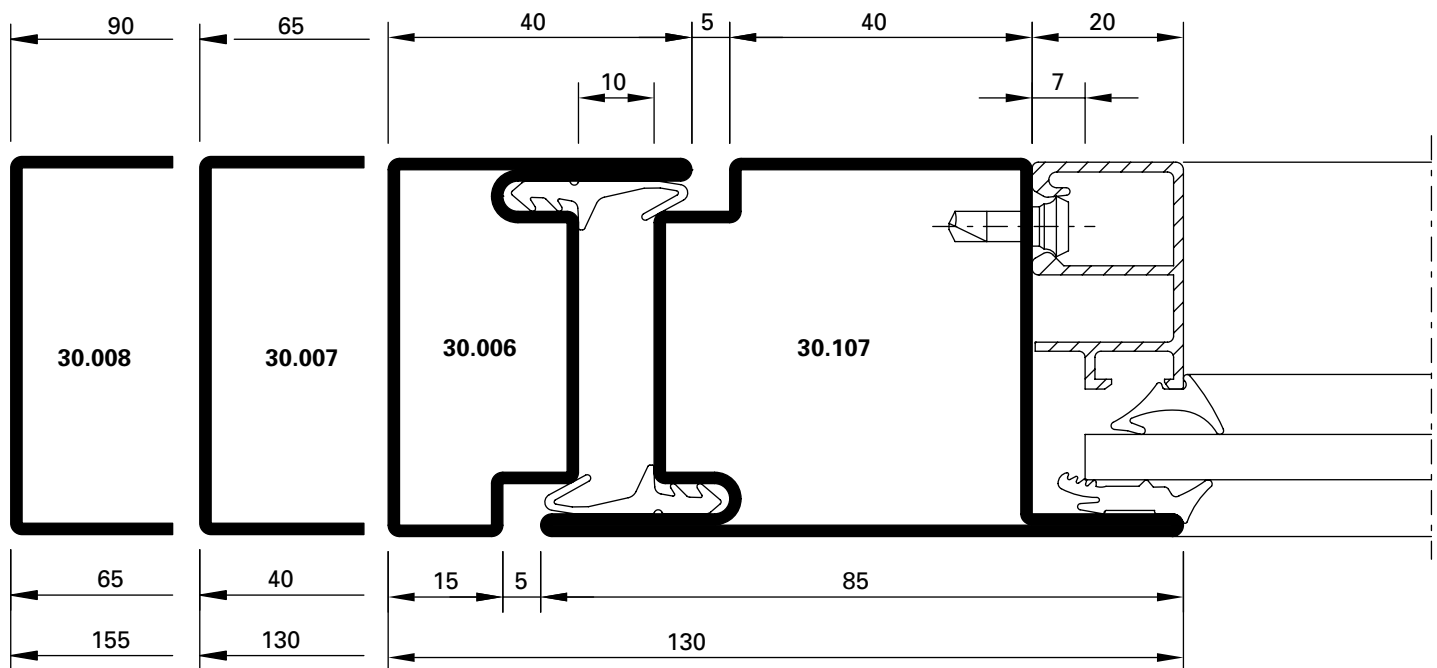

**DXF** **DWG** 41-0101-C-005

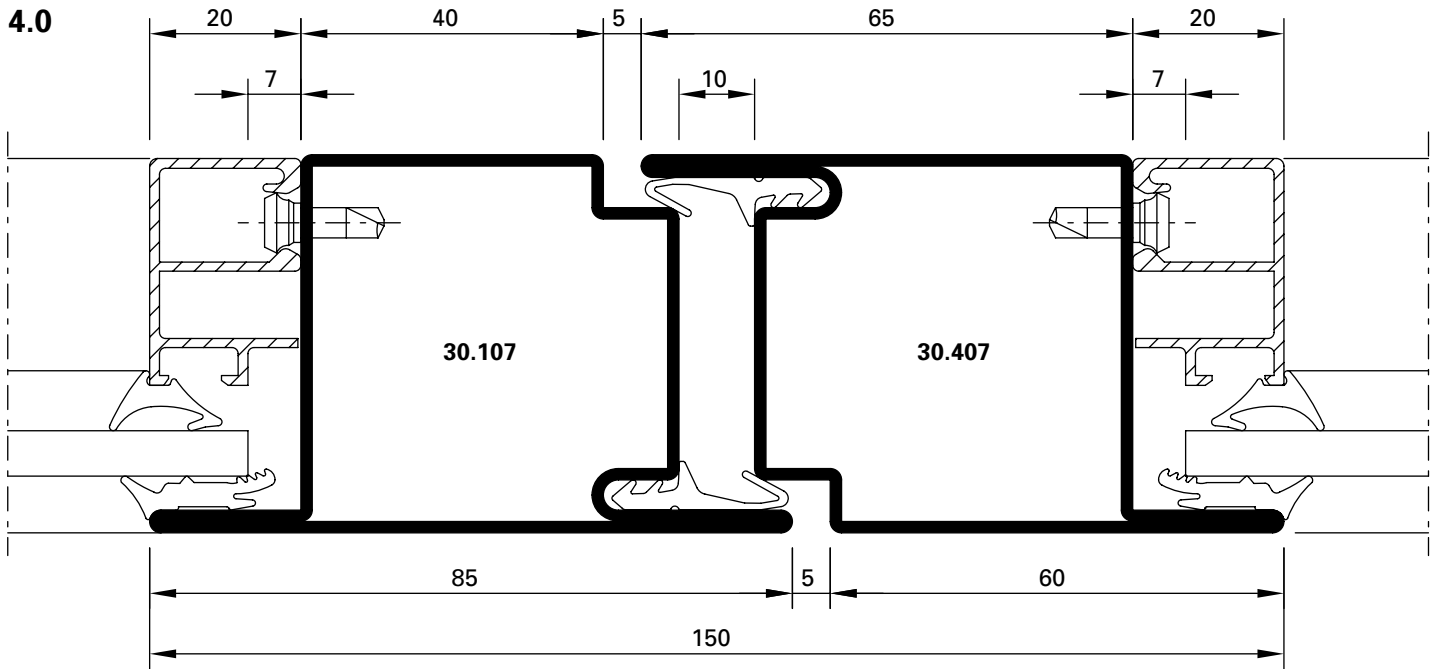

DXF DWG

41-0101-C-006

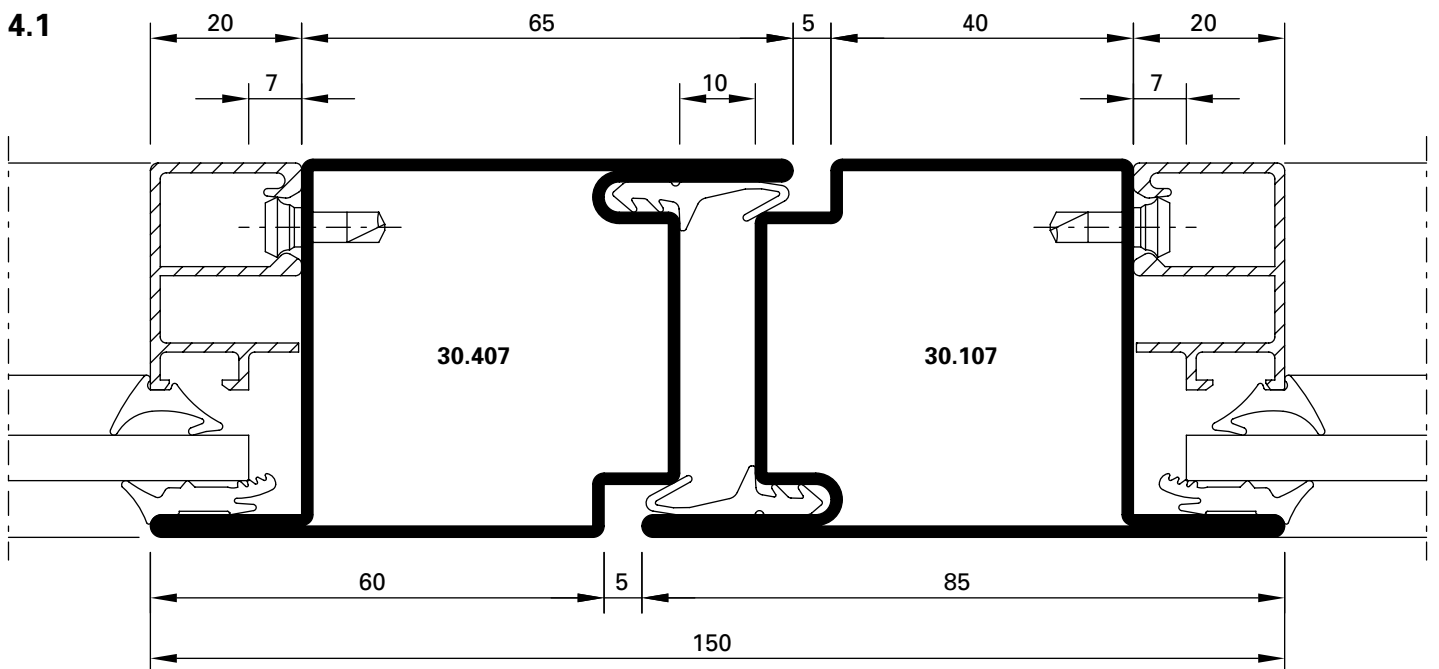

DXF DWG

41-0101-C-007

2.2

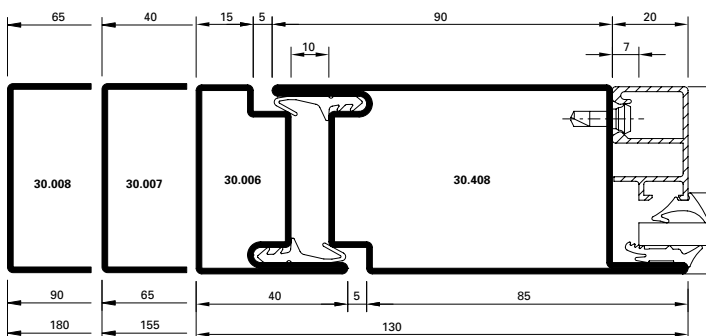

**DXF** **DWG** 41-0101-C-008

2.3

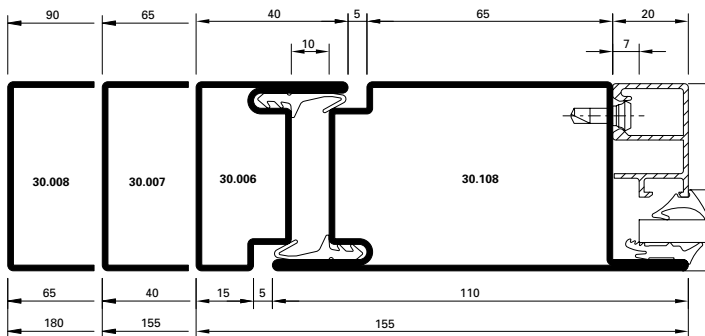

**DXF** **DWG** 41-0101-C-009

3.0

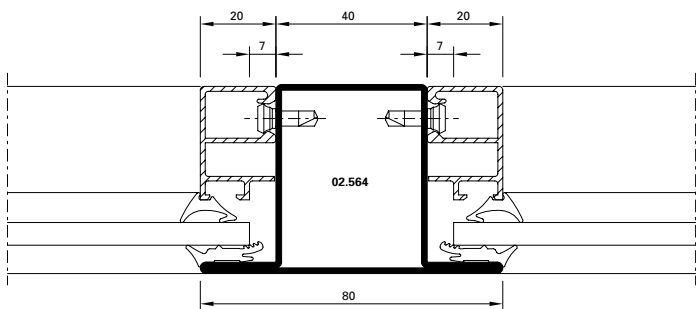

**DXF** **DWG** 41-0101-C-010

3.2

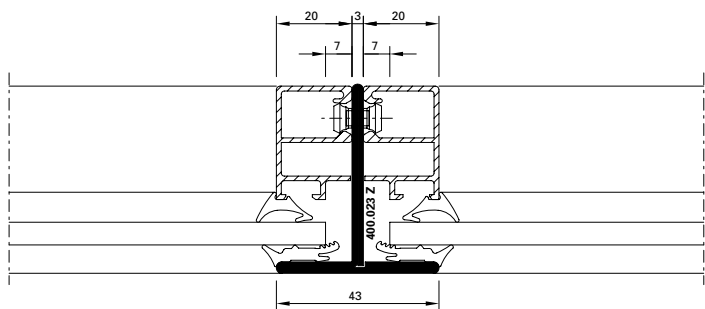

**DXF** **DWG** 41-0101-C-011

2.4

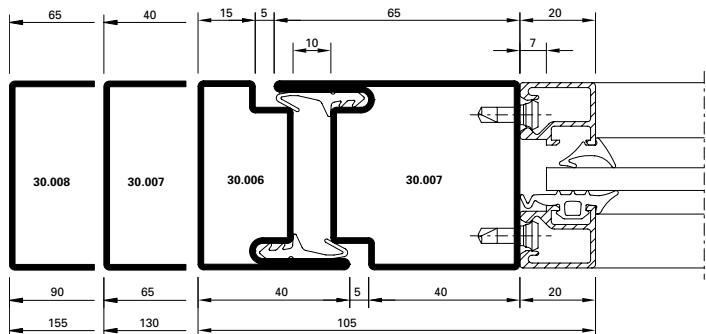

**DXF** **DWG** 41-0101-C-012

4.2

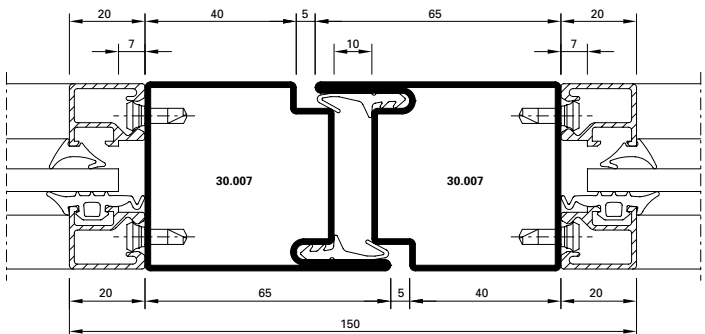

**DXF** **DWG** 41-0101-C-013

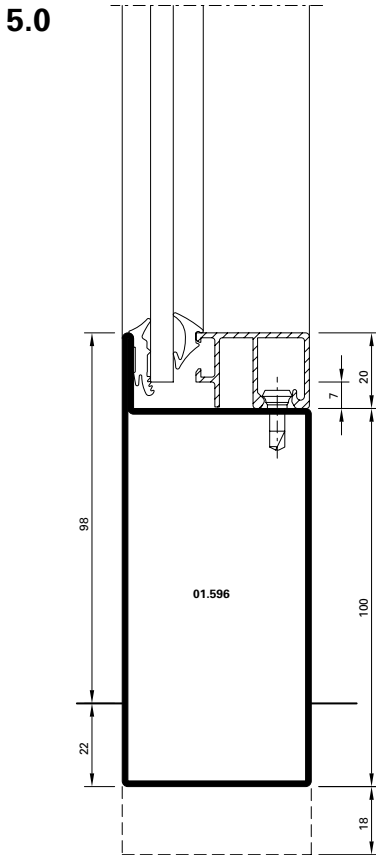

**DXF** **DWG** 41-0101-C-014

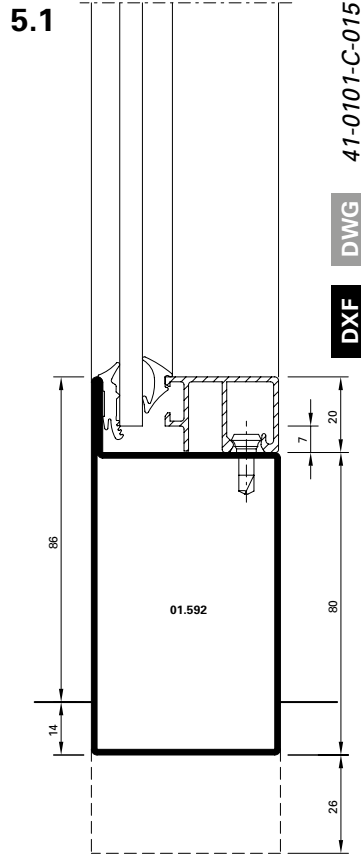

**DXF** **DWG** 41-0101-C-015

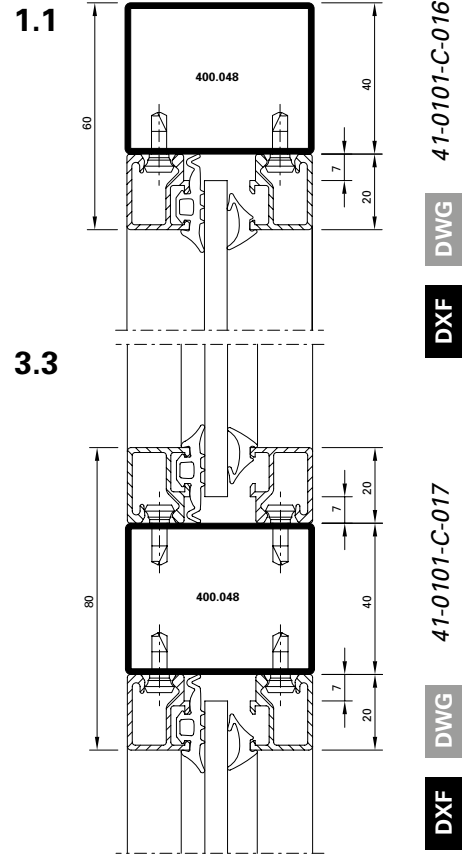

**DXF** **DWG** 41-0101-C-016

**DXF** **DWG** 41-0101-C-017

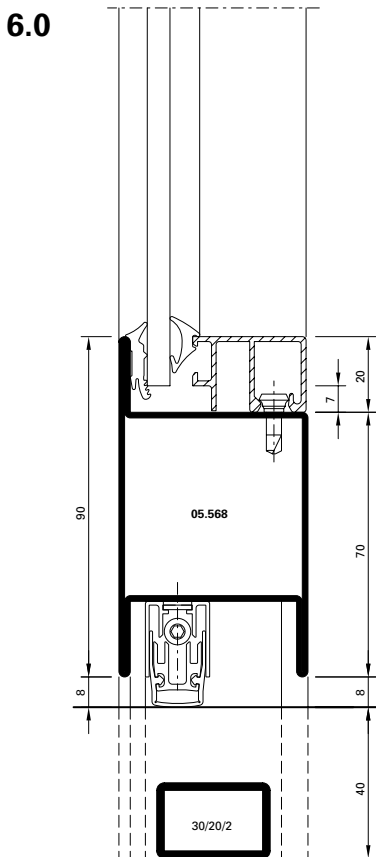

**DXF** **DWG** 41-0101-C-018

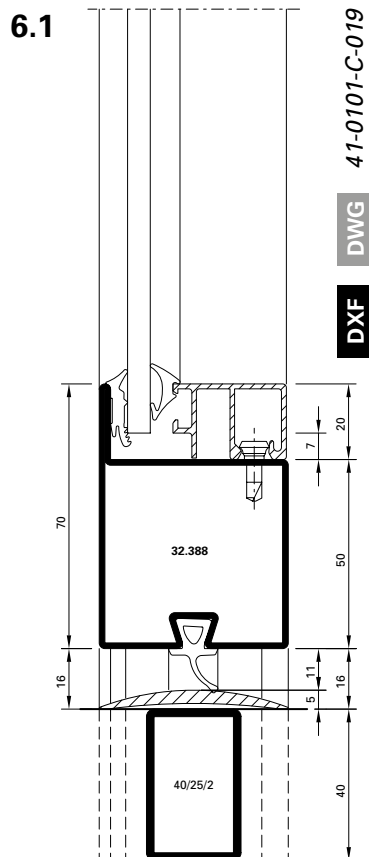

**DXF** **DWG** 41-0101-C-019

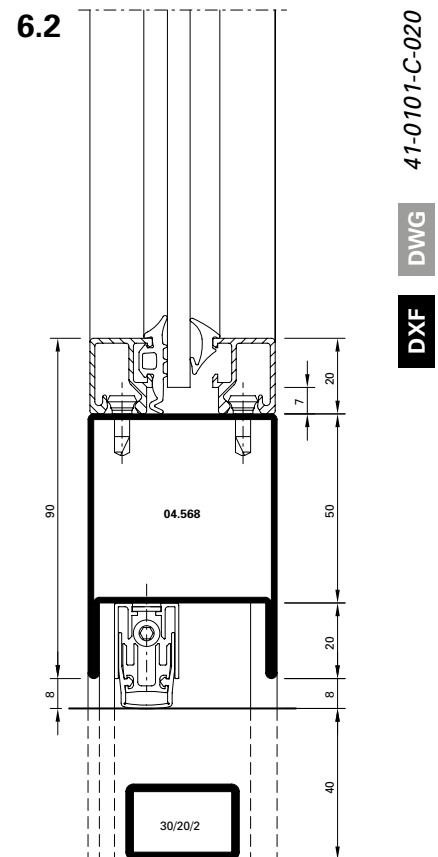

**DXF** **DWG** 41-0101-C-020

**Glasleisten-Varianten im Massstab 1:2**  
**Variantes de parcloses à l'échelle 1:2**  
**Glazing bead options on scale 1:2**

Jansen-Economy 50 RS DIN 18095  
 Jansen-Economy 50 RS DIN 18095  
 Jansen-Economy 50 RS DIN 18095

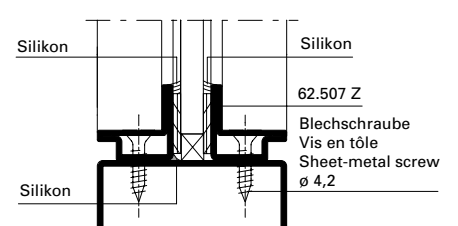
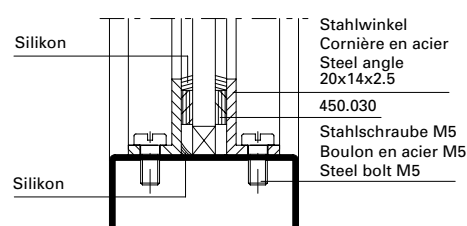
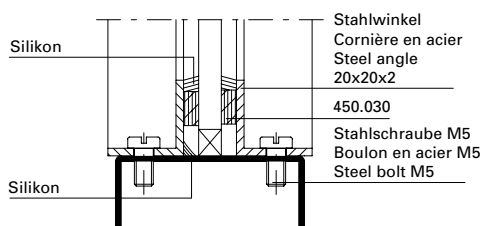
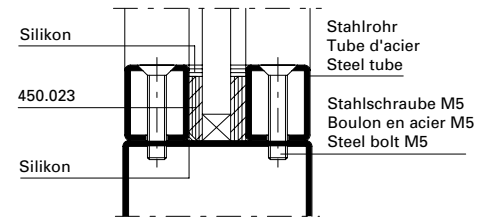
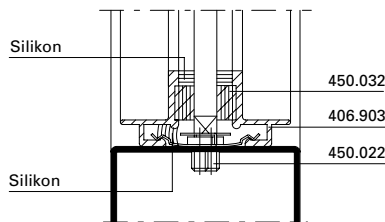
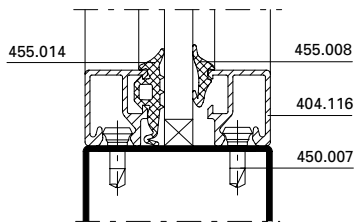
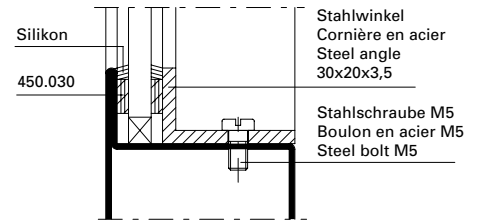
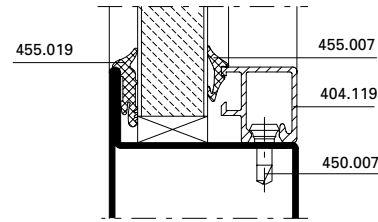
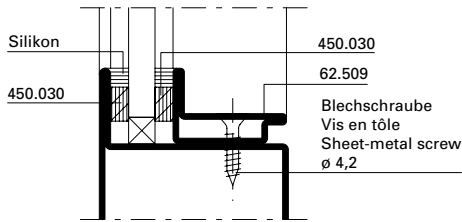
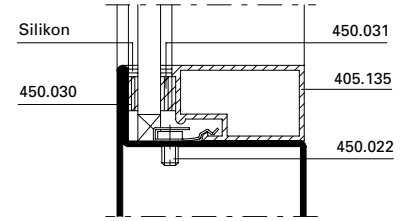
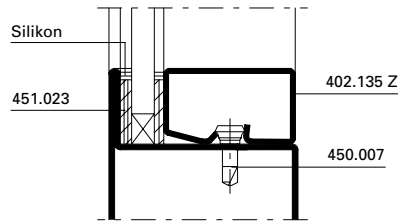
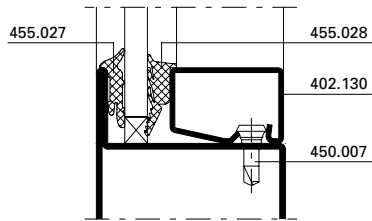
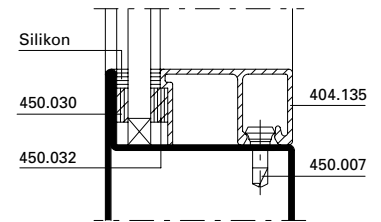
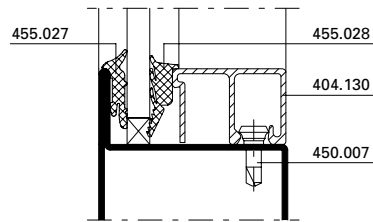
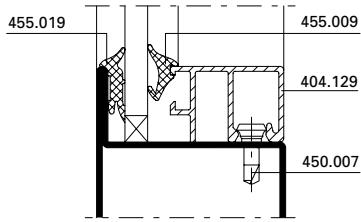

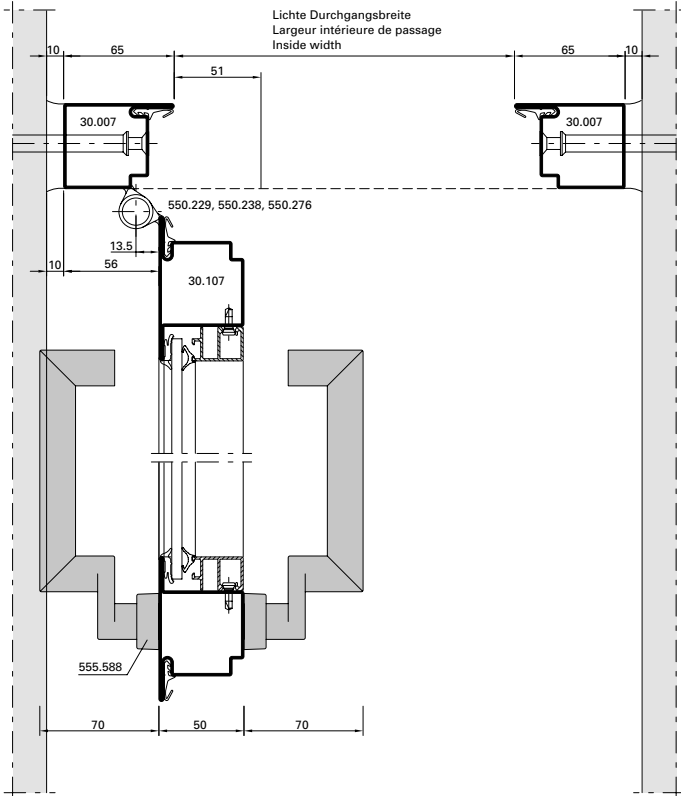

**DXF** **DWG** 41-0101-E-001

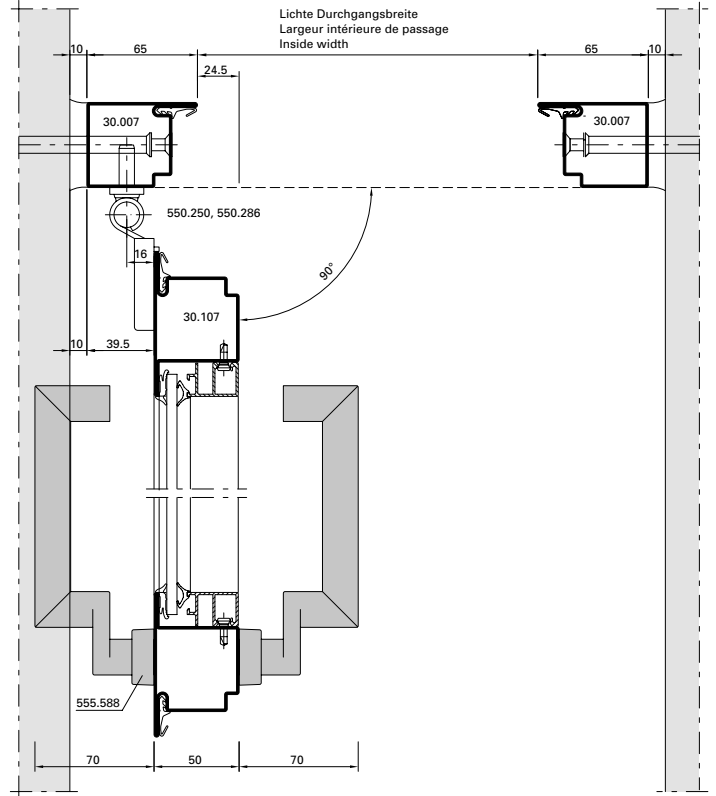

**DXF** **DWG** 41-0101-E-003

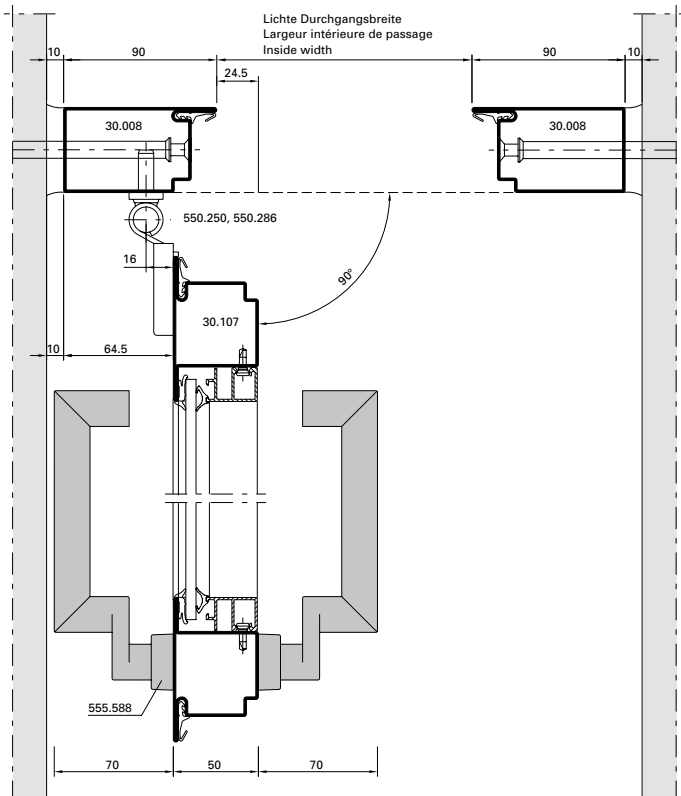

**DXF** **DWG** 41-0101-E-004

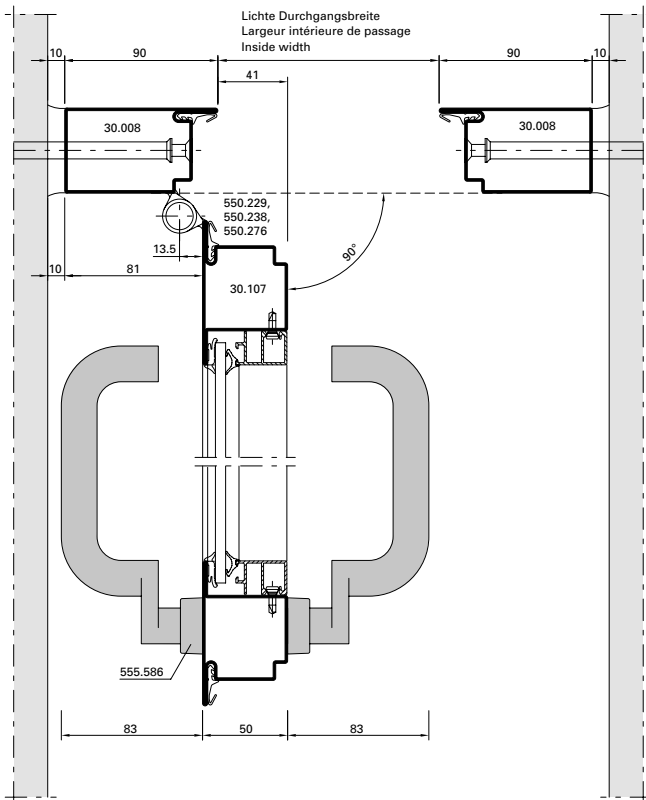

**DXF DWG** 41-0101-E-002

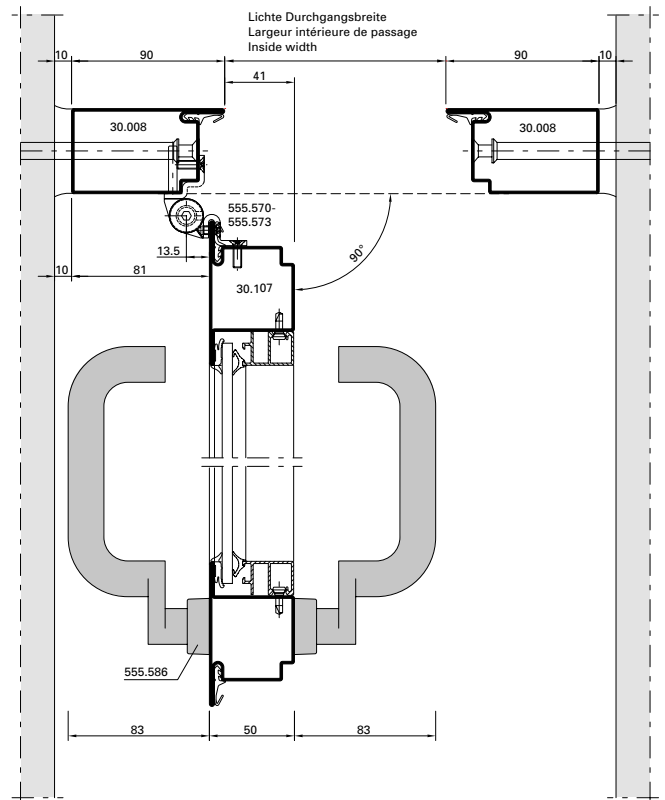

**DXF DWG** 41-0101-E-010

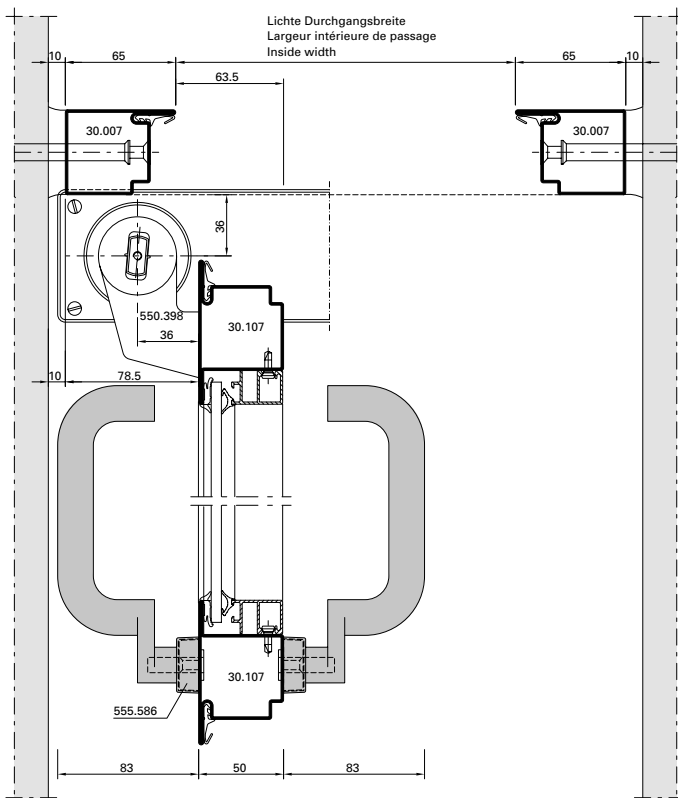

**DXF DWG** 41-0101-E-005

Anschlüsse am Bau im Masstab 1:2

Raccords au mur à l'échelle 1:2

Attachment to structure on scale 1:2

Jansen-Economy 50 RS DIN 18095

Jansen-Economy 50 RS DIN 18095

Jansen-Economy 50 RS DIN 18095

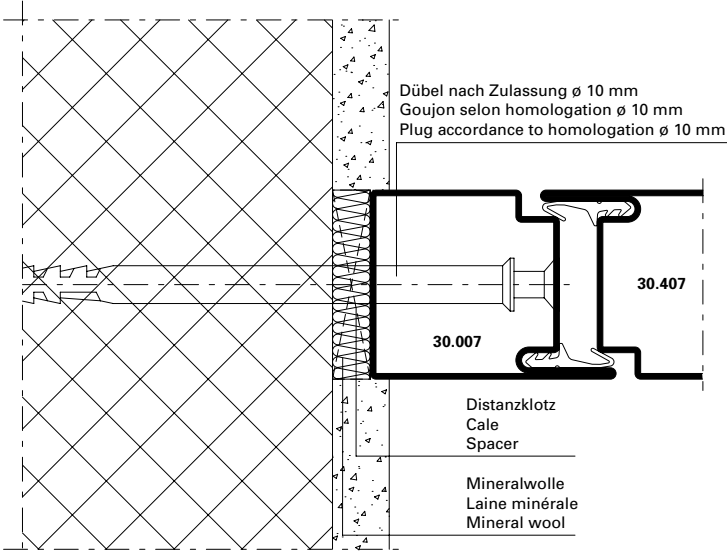

DXF DWG 41-0101-A-001

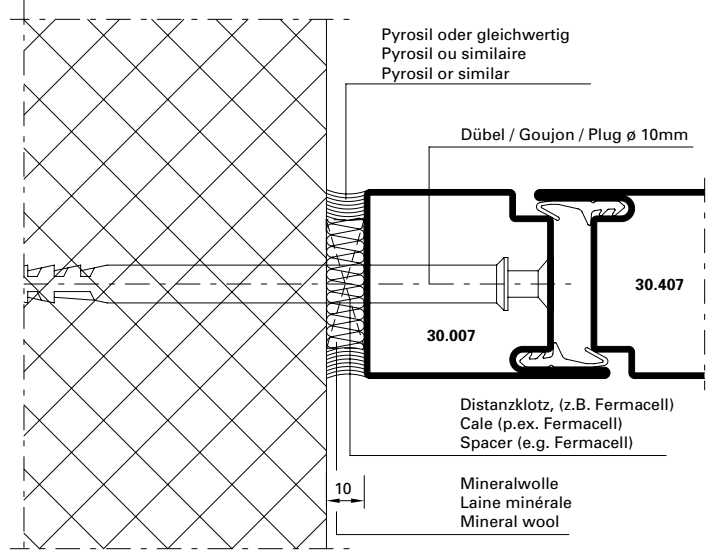

DXF DWG 41-0101-A-002

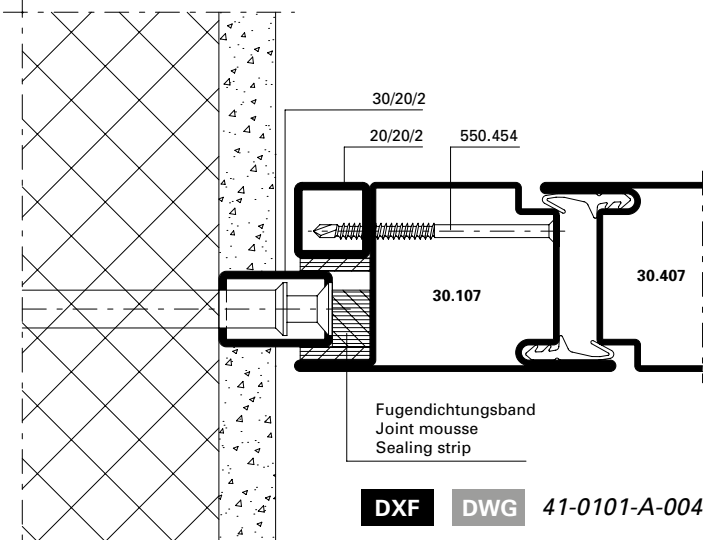

DXF DWG 41-0101-A-004

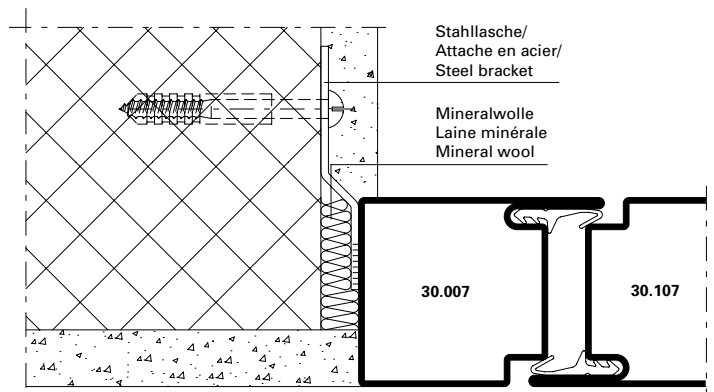

DXF DWG 41-0101-A-003

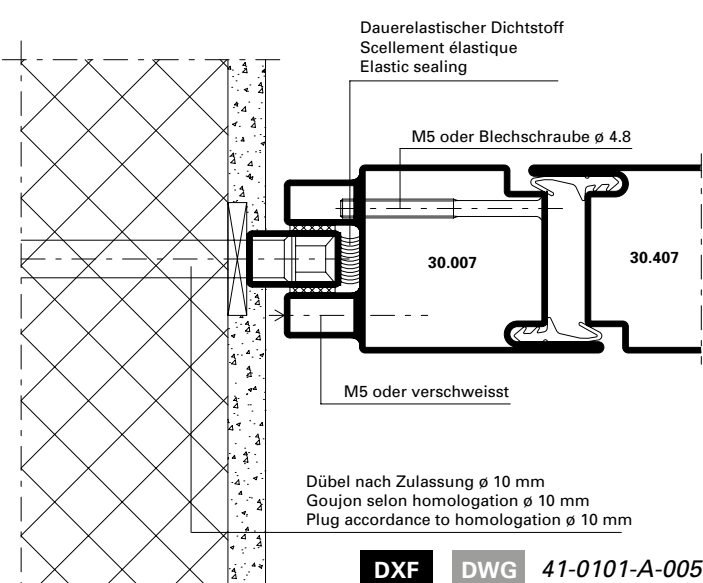

DXF DWG 41-0101-A-005

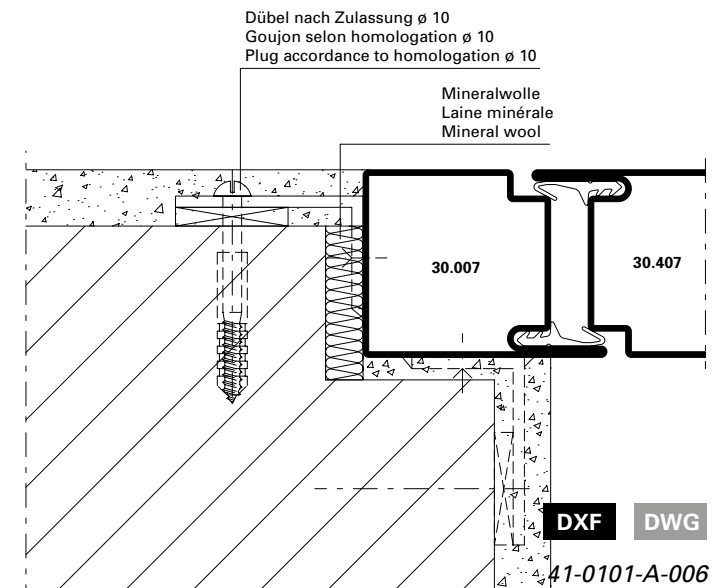

DXF DWG 41-0101-A-006



Anschlüsse am Bau im Masstab 1:2

Raccords au mur à l'échelle 1:2

Attachment to structure on scale 1:2

Jansen-Economy 50 RS DIN 18095

Jansen-Economy 50 RS DIN 18095

Jansen-Economy 50 RS DIN 18095

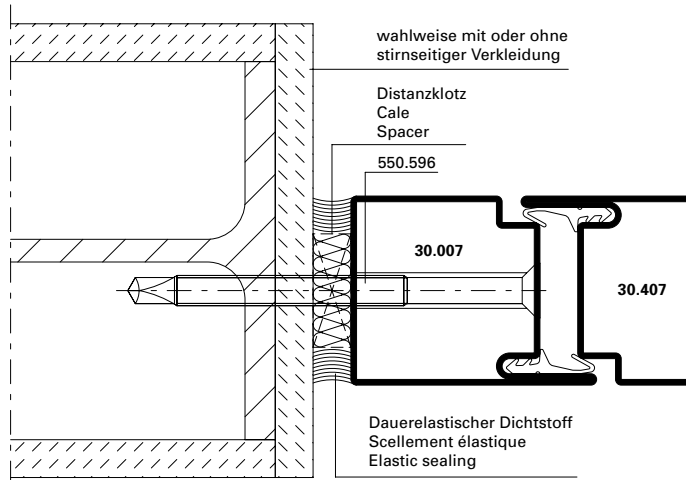

**DXF DWG** 41-0101-A-007

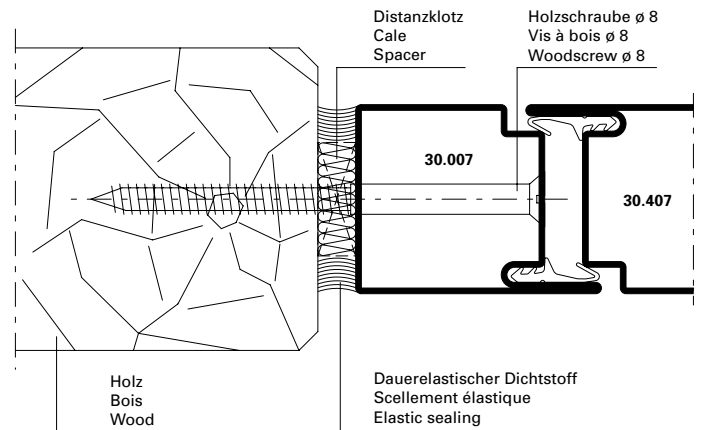

**DXF DWG** 41-0101-A-008

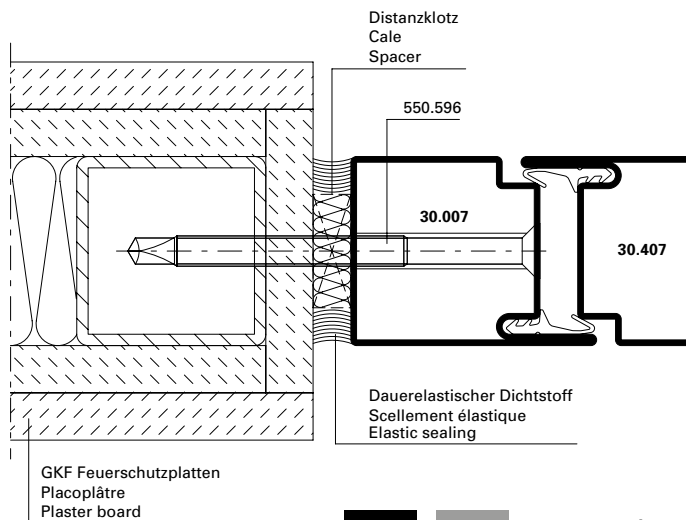

**DXF DWG** 41-0101-A-009

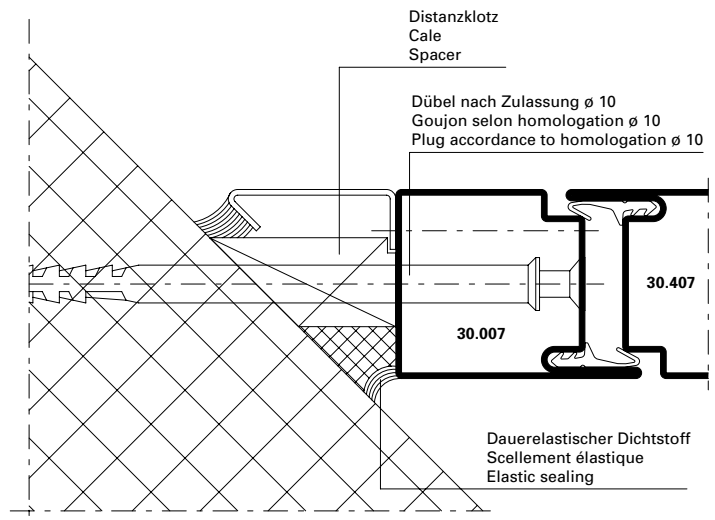

**DXF DWG** 41-0101-A-010

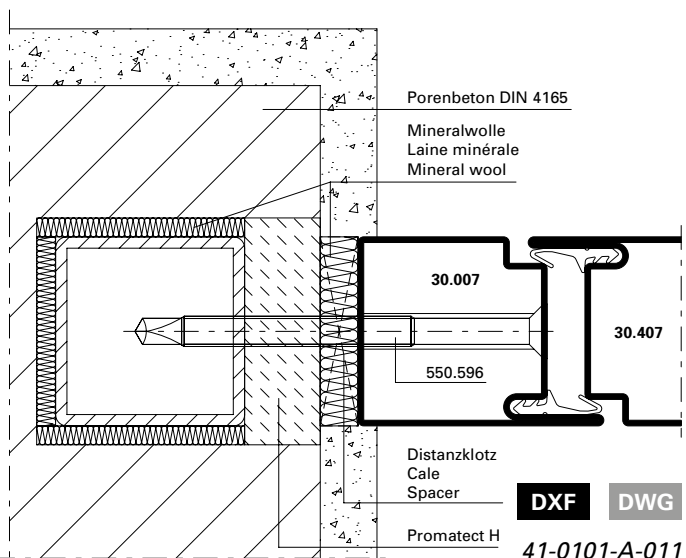

**DXF DWG** 41-0101-A-011

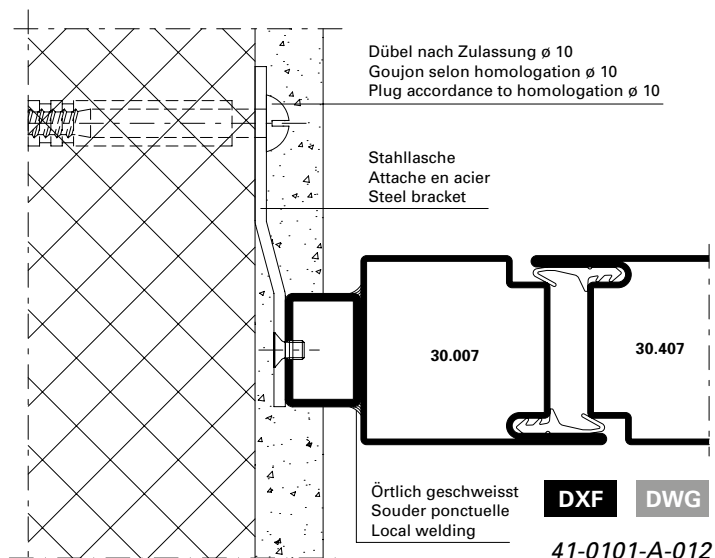

**DXF DWG** 41-0101-A-012

**Anschlüsse am Bau im Massstab 1:2**  
**Raccords au mur à l'échelle 1:2**  
**Attachment to structure on scale 1:2**

Jansen-Economy 50 RS DIN 18095  
 Jansen-Economy 50 RS DIN 18095  
 Jansen-Economy 50 RS DIN 18095

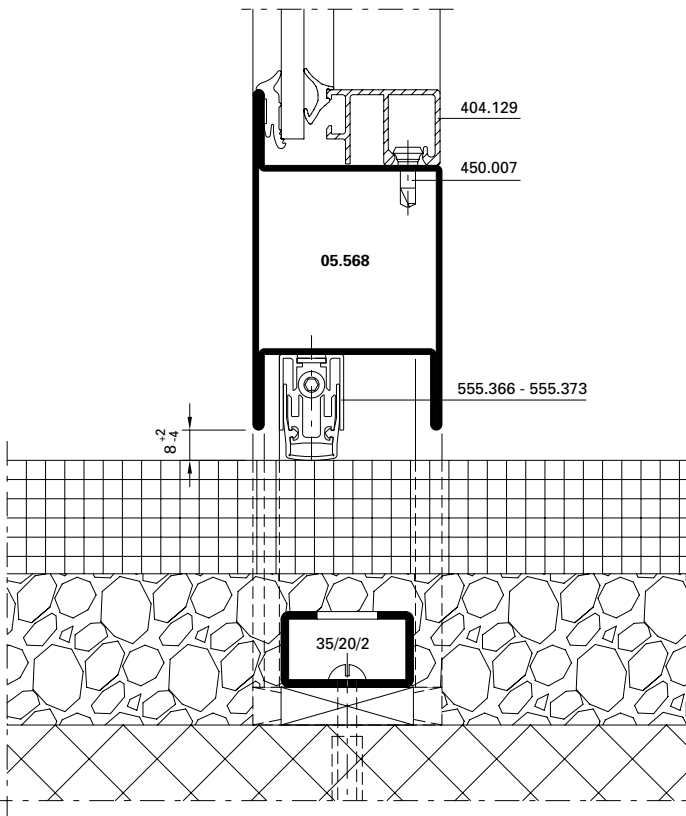

**DXF** **DWG** 41-0101-A-013

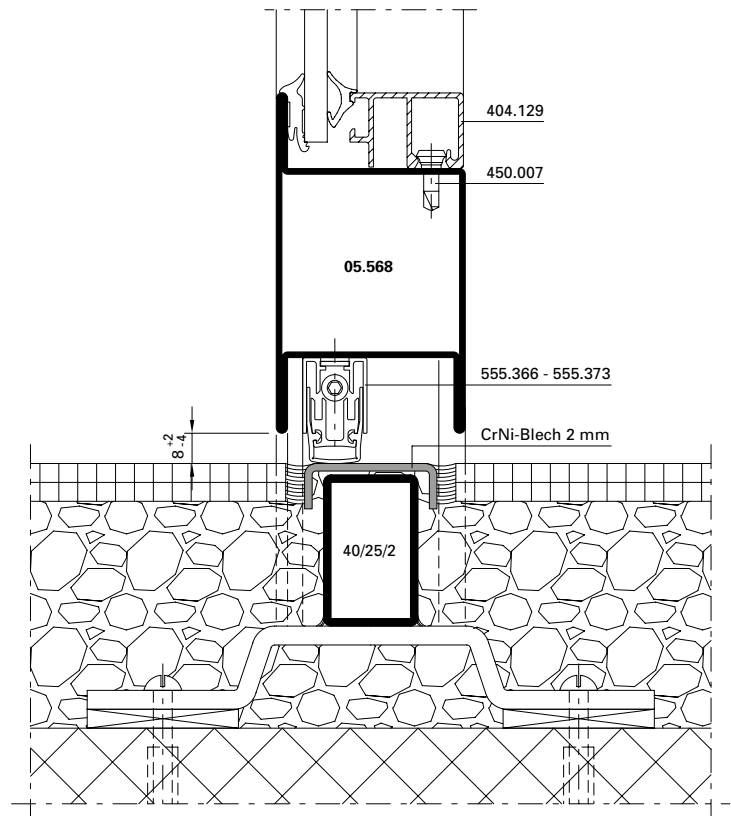

**DXF** **DWG** 41-0101-A-014

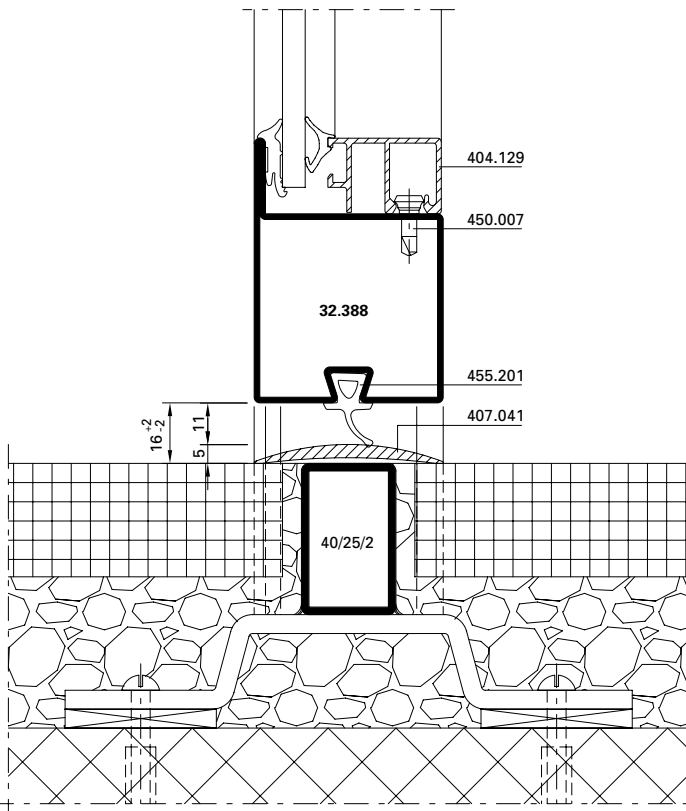

**DXF** **DWG** 41-0101-A-015

Bei Verwendung der Schwellendichtung 455.201 und Anschlagdichtung 455.006 muss der Standflügel von zweiflügeligen Türen nach unten verriegelt werden.



Dans le cas de l'utilisation du joint 455.201 et 455.006, le vantail semi-fixe des portes à deux vantaux devra être verrouillé aussi en bas.

When using gasket 455.201 and 455.006 on two leaf doors the fixed leaf must be locked towards the bottom.

Einflügelige Türen,  
 auswärts öffnend,  
 Flügelhöhe ≤ 2200 mm

Porte à un vantail,  
 ouvrant vers l'extérieur,  
 hauteur du vantail ≤ 2200 mm

Single leaf door,  
 outward opening,  
 leaf height ≤ 2200 mm

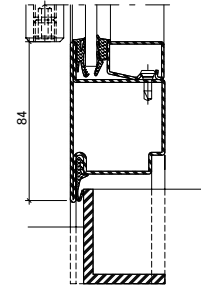
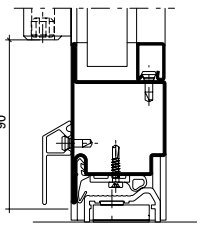
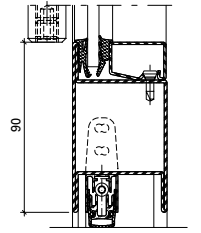
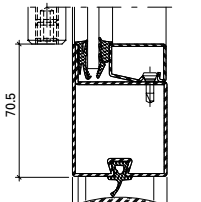
Variante	Beschlag Ferrure Fitting	 EN 12207	 EN 12208	 EN 12210
Anschlagdichtung Joint de butée Rebate gasket 	<b>1</b>	2	1A	C4 / C3*
	<b>2</b>	2	2A	C4 / C3*
	<b>3</b>	3	2A	C5 / C4*
Doppel-Anschlagdichtung Joint de base double Double rebate gasket 	<b>1</b>	4 / 3*	3A	C4 / C3*
	<b>2</b>	4	3A	C4 / C3*
	<b>3</b>	4	5A	C5 / C4*
Senkdichtung Joint seuil Drop seal 	<b>1</b>	2	1A	C4 / C3*
	<b>2</b>	2	2A	C4 / C3*
	<b>3</b>	3	2A	C5 / C4*
Auflaufdichtung Joint de contact Ramp seal 	<b>1</b>	2	0	C4 / C3*
	<b>2</b>	2	0	C4 / C3*
	<b>3</b>	2	0	C5 / C4*

\* Edelstahl  
 \* Acier Inox  
 \* Stainless steel

**1** Fallenriegel-Schloss  
 Serrure à mortaiser  
 Latch and bolt lock





**2** Schloss mit Obenverriegelung  
 Serrure avec verrouillage supérieur  
 Lock with top locking point

**3** Mehrfachverriegelungs-Schloss  
 Serrure à verrouillage multiple  
 Multipoint lock

Einflügelige Türen,  
 einwärts öffnend,  
 Flügelhöhe ≤ 2200 mm

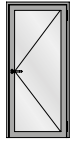
Porte à un vantail,  
 ouvrant vers l'intérieur,  
 hauteur du vantail ≤ 2200 mm

Single leaf door,  
 inward opening,  
 leaf height ≤ 2200 mm

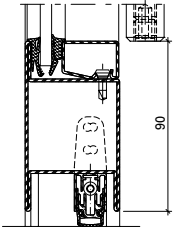
Variante	Beschlag Ferrure Fitting	 EN 12207	 EN 12208	 EN 12210
Senkdichtung Joint seuil Drop seal 	1	2	0	C4 / C3*
	2	2	0	C4 / C3*
	3	3	1A	C5 / C4*
Auflaufdichtung Joint de contact Ramp seal 	1	2	0	C4 / C3*
	2	2	0	C4 / C3*
	3	2	0	C5 / C4*

\* Edelstahl  
 \* Acier Inox  
 \* Stainless steel

1 Fallenriegel-Schloss  
 Serrure à mortaiser  
 Latch and bolt lock



2 Schloss mit Obenverriegelung  
 Serrure avec verrouillage supérieur  
 Lock with top locking point

3 Mehrfachverriegelungs-Schloss  
 Serrure à verrouillage multiple  
 Multipoint lock

Einflügelige Türen,  
 auswärts öffnend,  
 Flügelhöhe ≤ 3000 mm

Porte à un vantail,  
 ouvrant vers l'extérieur,  
 hauteur du vantail ≤ 3000 mm

Single leaf door,  
 outward opening,  
 leaf height ≤ 3000 mm

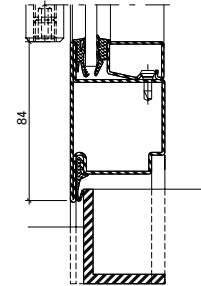
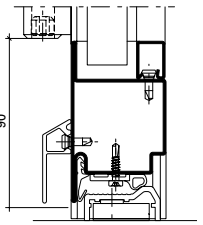
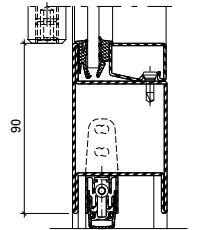
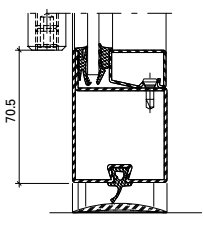
Variante	Beschlag Ferrure Fitting	 EN 12207	 EN 12208	 EN 12210
Anschlagdichtung Joint de butée Rebate gasket 	<b>1</b>	1	0	C1
	<b>2</b>	1	0	C1
	<b>3</b>	1	0	C2
Doppel-Anschlagdichtung Joint de base double Double rebate gasket 	<b>1</b>	1	1A	C1
	<b>2</b>	1	1A	C1
	<b>3</b>	2	2A	C2
Senkdichtung Joint seuil Drop seal 	<b>1</b>	1	0	C1
	<b>2</b>	1	0	C1
	<b>3</b>	1	0	C2
Auflaufdichtung Joint de contact Ramp seal 	<b>1</b>	0	0	C1
	<b>2</b>	0	0	C1
	<b>3</b>	1	0	C2

**1** Fallenriegel-Schloss  
Serrure à mortaiser  
Latch and bolt lock





**2** Schloss mit Obenverriegelung  
Serrure avec verrouillage supérieur  
Lock with top locking point

**3** Mehrfachverriegelungs-Schloss  
Serrure à verrouillage multiple  
Multipoint lock

Einflügelige Türen,  
 einwärts öffnend,  
 Flügelhöhe ≤ 3000 mm

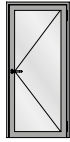
Porte à un vantail,  
 ouvrant vers l'intérieur,  
 hauteur du vantail ≤ 3000 mm

Single leaf door,  
 inward opening,  
 leaf height ≤ 3000 mm

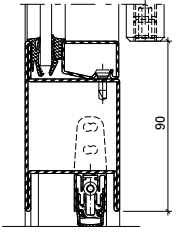
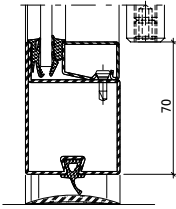
Variante		Beschlag Ferrure Fitting	 EN 12207	 EN 12208	 EN 12210
Senkdichtung Joint seuil Drop seal		❶	1	0	C1
		❷	1	0	C1
		❸	1	0	C2
Auflaufdichtung Joint de contact Ramp seal		❶	0	0	C1
		❷	0	0	C1
		❸	1	0	C2

❶ Fallenriegel-Schloss  
 Serrure à mortaiser  
 Latch and bolt lock



❷ Schloss mit Obenverriegelung  
 Serrure avec verrouillage supérieur  
 Lock with top locking point

❸ Mehrfachverriegelungs-Schloss  
 Serrure à verrouillage multiple  
 Multipoint lock

Zweiflügelige Türen,  
 auswärts öffnend,  
 Flügelhöhe ≤ 2200 mm

Porte à deux vantaux,  
 ouvrant vers l'extérieur,  
 hauteur du vantail ≤ 2200 mm

Double leaf door,  
 outward opening,  
 leaf height ≤ 2200 mm

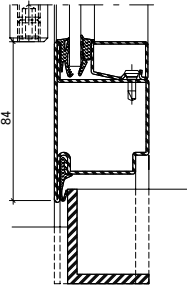
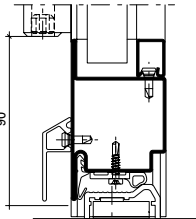
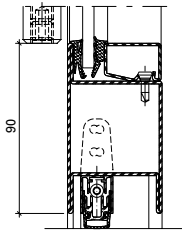
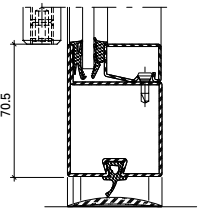
Variante	Beschlag Ferrure Fitting	 EN 12207	 EN 12208	 EN 12210
Anschlagdichtung Joint de butée Rebate gasket 	<b>1</b>	2	1A / 0*	C2
	<b>2</b>	2	2A / 0*	C2
	<b>3</b>	2	2A / 1A*	C3
Doppel-Anschlagdichtung Joint de base double Double rebate gasket 	<b>1</b>	2	2A	C2
	<b>2</b>	2	2A	C2
	<b>3</b>	3	3A	C3
Senkdichtung Joint seuil Drop seal 	<b>1</b>	2	1A / 0*	C2
	<b>2</b>	2	2A / 0*	C2
	<b>3</b>	2	2A / 1A*	C3
Auflaufdichtung Joint de contact Ramp seal 	<b>1</b>	2	0	C2
	<b>2</b>	2	0	C2
	<b>3</b>	2	0	C3

\* Edelstahl  
 \* Acier Inox  
 \* Stainless steel

**1** Fallenriegel-Schloss  
 Serrure à mortaiser  
 Latch and bolt lock





**2** Schloss mit Oberverriegelung  
 Serrure avec verrouillage supérieur  
 Lock with top locking point

**3** Mehrfachverriegelungs-Schloss  
 Serrure à verrouillage multiple  
 Multipoint lock

Zweiflügelige Türen,  
 einwärts öffnend,  
 Flügelhöhe ≤ 2200 mm

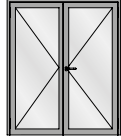
Porte à deux vantaux,  
 ouvrant vers l'intérieur,  
 hauteur du vantail ≤ 2200 mm

Double leaf door,  
 inward opening,  
 leaf height ≤ 2200 mm

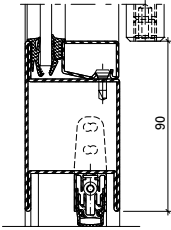
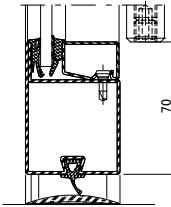
Variante		Beschlag Ferrure Fitting	 EN 12207	 EN 12208	 EN 12210
Senkdichtung Joint seuil Drop seal		❶	2	0	C2
		❷	2	0	C2
		❸	2	0	C3
Auflaufdichtung Joint de contact Ramp seal		❶	2	0	C2
		❷	2	0	C2
		❸	2	0	C3

❶ Fallenriegel-Schloss  
 Serrure à mortaiser  
 Latch and bolt lock

❷ Schloss mit Obenverriegelung  
 Serrure avec verrouillage supérieur  
 Lock with top locking point



❸ Mehrfachverriegelungs-Schloss  
 Serrure à verrouillage multiple  
 Multipoint lock



Zweiflügelige Türen,  
 auswärts öffnend,  
 Flügelhöhe ≤ 3000 mm

Porte à deux vantaux,  
 ouvrant vers l'extérieur,  
 hauteur du vantail ≤ 3000 mm

Double leaf door,  
 outward opening,  
 leaf height ≤ 3000 mm

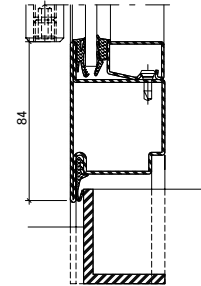
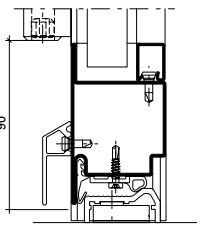
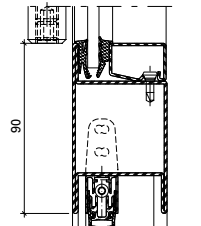
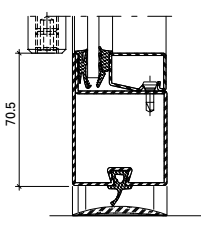
Variante	Beschlag Ferrure Fitting	 EN 12207	 EN 12208	 EN 12210
Anschlagdichtung Joint de butée Rebate gasket 	<b>1</b>	0	0	C1
	<b>2</b>	0	0	C1
	<b>3</b>	1	0	C2
Doppel-Anschlagdichtung Joint de base double Double rebate gasket 	<b>1</b>	1	0	C1
	<b>2</b>	1	0	C1
	<b>3</b>	2	0	C2
Senkdichtung Joint seuil Drop seal 	<b>1</b>	0	0	C1
	<b>2</b>	0	0	C1
	<b>3</b>	1	0	C2
Auflaufdichtung Joint de contact Ramp seal 	<b>1</b>	0	0	C1
	<b>2</b>	0	0	C1
	<b>3</b>	1	0	C2

\* Edelstahl  
 \* Acier Inox  
 \* Stainless steel

**1** Fallenriegel-Schloss  
 Serrure à mortaiser  
 Latch and bolt lock





**2** Schloss mit Obenverriegelung  
 Serrure avec verrouillage supérieur  
 Lock with top locking point

**3** Mehrfachverriegelungs-Schloss  
 Serrure à verrouillage multiple  
 Multipoint lock

Zweiflügelige Türen,  
 einwärts öffnend,  
 Flügelhöhe ≤ 3000 mm

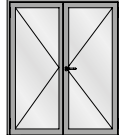
Porte à deux vantaux,  
 ouvrant vers l'intérieur,  
 hauteur du vantail ≤ 3000 mm

Double leaf door,  
 inward opening,  
 leaf height ≤ 3000 mm

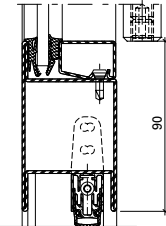
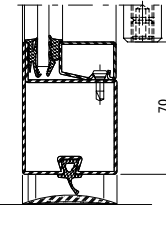
Variante		Beschlag Ferrure Fitting	 EN 12207	 EN 12208	 EN 12210
Senkdichtung Joint seuil Drop seal		❶	0	0	C1
		❷	0	0	C1
		❸	1	0	C2
Auflaufdichtung Joint de contact Ramp seal		❶	0	0	C1
		❷	0	0	C1
		❸	1	0	C2

❶ Fallenriegel-Schloss  
 Serrure à mortaiser  
 Latch and bolt lock

❷ Schloss mit Obenverriegelung  
 Serrure avec verrouillage supérieur  
 Lock with top locking point

❸ Mehrfachverriegelungs-Schloss  
 Serrure à verrouillage multiple  
 Multipoint lock

**U<sub>f</sub>-Werte**  
(nach EN ISO 10077-2:2018-01)

Auf den folgenden Seiten finden Sie die U<sub>f</sub>-Werte für die verschiedenen Anwendungen von Jansen-Economy 50 RS.

Sie basieren auf folgenden Grundlagen:

**Stahl**

- Profile bandverzinkter Stahl, unbeschichtet
- Stahl-Glasleisten
- Trockenverglasung
- Nassverglasung

**Edelstahl**

- Profile Edelstahl, blank
- Edelstahl-Glasleisten
- Trockenverglasung
- Nassverglasung

**Valeurs U<sub>f</sub>**  
(selon EN ISO 10077-2:2018-01)

Vous trouverez les valeurs U<sub>f</sub> pour les différentes applications Jansen-Economy 50 RS. dans les pages qui suivent.

Elles se basent sur les principes suivants:

**Acier**

- Profilés en bande d'acier zingué, sans revêtement
- Parcloses en acier
- Vitrage à sec
- Vitrage à mastic

**Acier Inox**

- Profilés en acier Inox, brut
- Parcloses en acier Inox
- Vitrage à sec
- Vitrage à mastic

**U<sub>f</sub> values**  
(according to  
EN ISO 10077-2:2018-01)

On the following pages you will find the U<sub>f</sub> values for the various applications for Jansen-Economy 50 RS.

They are based on the following:

**Steel**

- Strip galvanised steel profiles, uncoated
- Steel glazing beads
- Glazing with dry glazing
- Glazing with sealing

**Stainless steel**

- Stainless steel profiles, bright
- Stainless steel glazing beads
- Glazing with dry glazing
- Glazing with sealing

**U<sub>f</sub>-Werte**  
 (nach EN ISO 10077-2:2018-01)

**Valeurs U<sub>f</sub>**  
 (selon EN ISO 10077-2:2018-01)

**U<sub>f</sub> values**  
 (according to EN ISO 10077-2:2018-01)

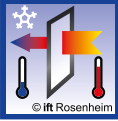
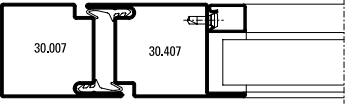
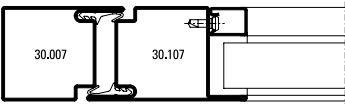
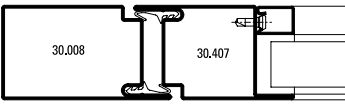
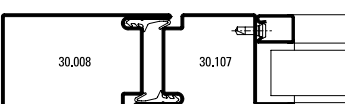
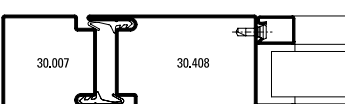
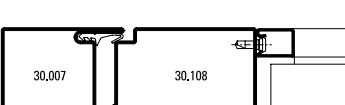
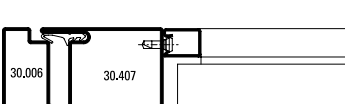
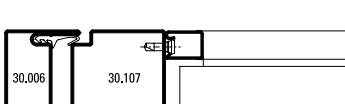
	Füllelementstärken Elements de remplissages Infill elements <b>&gt; 24 mm</b>
	<b>5,4 W/m²K</b>
	<b>5,4 W/m²K</b>
	<b>5,2 W/m²K</b>
	<b>5,2 W/m²K</b>
	<b>5,1 W/m²K</b>
	<b>5,2 W/m²K</b>
	<b>5,5 W/m²K</b>
	<b>5,5 W/m²K</b>

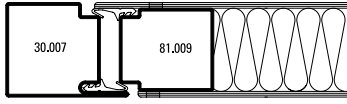
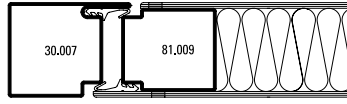
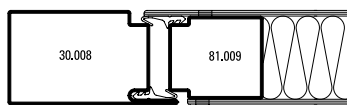
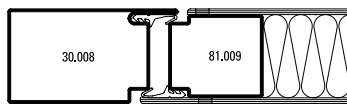
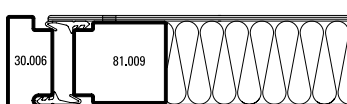
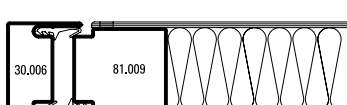
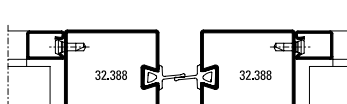

	Füllelementstärken Elements de remplissages Infill elements <b>&gt; 24 mm</b>
	<b>5,3 W/m²K</b>
	<b>5,3 W/m²K</b>
	<b>5,1 W/m²K</b>
	<b>5,1 W/m²K</b>
	<b>5,4 W/m²K</b>
	<b>5,4 W/m²K</b>
	<b>6,6 W/m²K</b>

**U<sub>f</sub>-Werte**  
 (nach EN ISO 10077-2:2018-01)

**Valeurs U<sub>f</sub>**  
 (selon EN ISO 10077-2:2018-01)

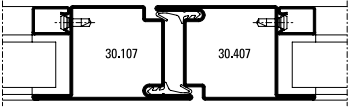
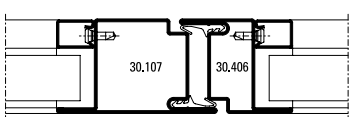
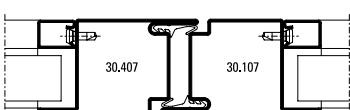
**U<sub>f</sub> values**  
 (according to EN ISO 10077-2:2018-01)

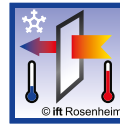
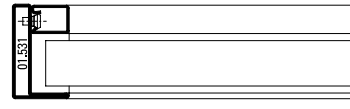
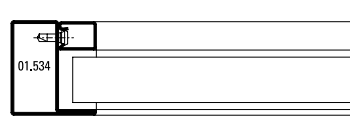
	Füllelementstärken Elements de remplissages Infill elements <b>&gt; 24 mm</b>
	<b>5,6 W/m²K</b>
	<b>5,8 W/m²K</b>
	<b>5,6 W/m²K</b>

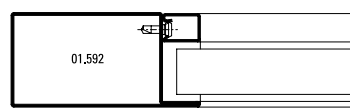
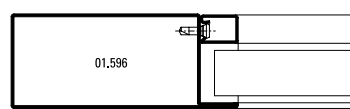
	Füllelementstärken Elements de remplissages Infill elements <b>&gt; 24 mm</b>
	<b>7,3 W/m²K</b>
	<b>6,5 W/m²K</b>
	<b>6,0 W/m²K</b>
	<b>5,2 W/m²K</b>
	<b>4,9 W/m²K</b>

**U<sub>f</sub>-Werte**  
 (nach EN ISO 10077-2:2018-01)

**Valeurs U<sub>f</sub>**  
 (selon EN ISO 10077-2:2018-01)

**U<sub>f</sub> values**  
 (according to EN ISO 10077-2:2018-01)

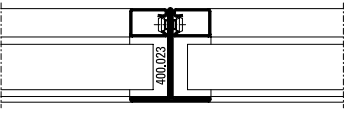
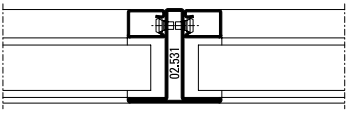
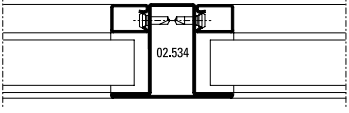
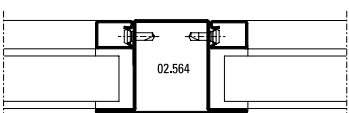
	Füllelementstärken Elements de remplissages Infill elements > 24 mm
	<b>7,6 W/m²K</b>
	<b>7,2 W/m²K</b>
	<b>6,6 W/m²K</b>
	<b>6,2 W/m²K</b>

**U<sub>f</sub>-Werte**  
 (nach EN ISO 10077-2:2018-01)

**Valeurs U<sub>f</sub>**  
 (selon EN ISO 10077-2:2018-01)

**U<sub>f</sub> values**  
 (according to EN ISO 10077-2:2018-01)

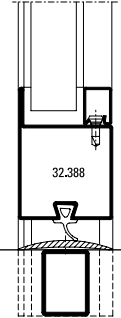
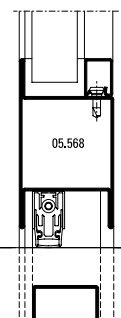
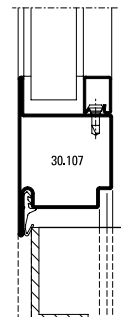
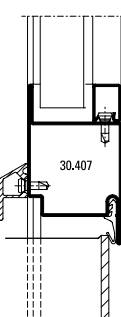
	Füllelementstärken Elements de remplissages Infill elements > 24 mm
	5,4 W/m <sup>2</sup> K
	5,4 W/m <sup>2</sup> K
	5,4 W/m <sup>2</sup> K
	5,4 W/m <sup>2</sup> K

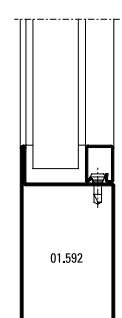
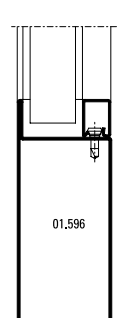
	Füllelementstärken Elements de remplissages Infill elements > 24 mm
	5,2 W/m <sup>2</sup> K
	4,9 W/m <sup>2</sup> K

**U<sub>f</sub>-Werte**  
 (nach EN ISO 10077-2:2018-01)

**Valeurs U<sub>f</sub>**  
 (selon EN ISO 10077-2:2018-01)

**U<sub>f</sub> values**  
 (according to EN ISO 10077-2:2018-01)



<p>© ift Rosenheim</p>	Füllelementstärken Elements de remplissages Infill elements > 24 mm
	<b>5,1 W/m²K</b>
	<b>4,4 W/m²K</b>
	<b>4,6 W/m²K</b>
	<b>4,8 W/m²K</b>
	<b>4,6 W/m²K</b>

<p>© ift Rosenheim</p>	Füllelementstärken Elements de remplissages Infill elements > 24 mm
	<b>5,6 W/m²K</b>
	<b>5,0 W/m²K</b>
	<b>5,5 W/m²K</b>
	<b>5,0 W/m²K</b>



**Leistungseigenschaften nach EN 14351-1**  
**Caractéristiques de performance selon EN 14351-1**  
**Performance characteristics according to EN 14351-1**

Jansen-Economy 50 RS DIN 18095  
Jansen-Economy 50 RS DIN 18095  
Jansen-Economy 50 RS DIN 18095

**U<sub>f</sub>-Werte**  
(nach EN ISO 10077-2:2018-01)

**Valeurs U<sub>f</sub>**  
(selon EN ISO 10077-2:2018-01)

**U<sub>f</sub> values**  
(according to EN ISO 10077-2:2018-01)



	<p>Füllelementstärken Elements de remplissages Infill elements</p> <p><b>&gt; 24 mm</b></p>
	<p><b>4,6 W/m²K</b></p>



## Schallschutz

### Ausführungsvarianten

Die nachfolgende Typenübersicht ergibt einen Überblick über die beurteilten Varianten.

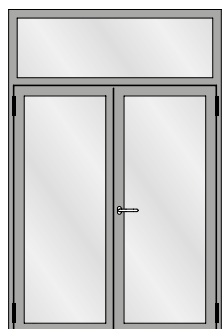
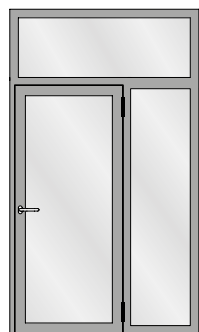
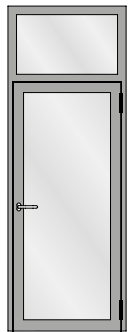
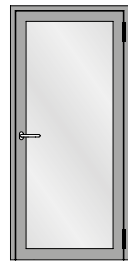

## Isolation phonique

### Modèles

L'aperçu des types suivant fournit une vue d'ensemble des variantes examinées.

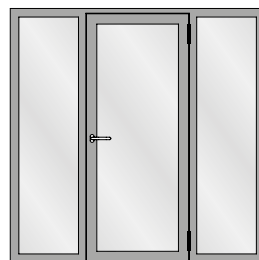
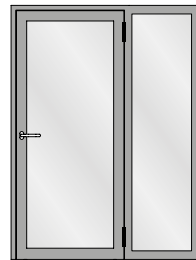
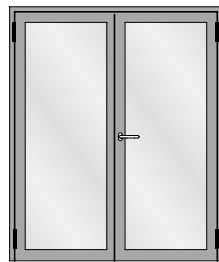

## Sound insulation

### Design range

The following overview of types provides an overview of the evaluated designs.

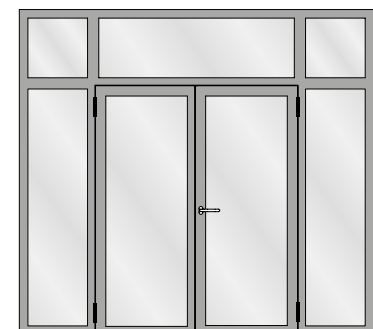
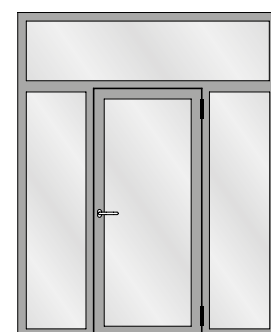

Schallschutz

Isolation phonique

Sound insulation

Tabelle A1

Korrekturtabelle für Jansen-Economy-Türen mit Glasfüllungen

Tableau A1

Tableau de correction pour les portes Jansen-Economy avec vitrage

Table A1

Correction table for Jansen-Economy doors with glass

	1	2	3	4	5	6	7	8	9	10	11
	<b>Türe</b> mit zwei absenkba- ren Bodendichtungen <b>Porte</b> avec deux joint seuil automatique <b>Door</b> with two threshold gaskets that can be lowered	<b>Glas</b>  <b>Verre</b>  <b>Glass</b>	<b>Korrekturen</b>  <b>Corrections</b>  <b>Corrections</b>								
	$R_{w(C, Ctr)}$ dB	$R_{w, P, Glas}$ dB	$K_S$ dB	$K_{FV}$ dB	$K_{Nass}$ dB	$K_{1aB}$ dB	$K_{W/S}$ dB	$K_{G 0,4}$ dB	$K_{G 1,8}$ dB	$K_{G 2,6}$ dB	$K_{G 3,2}$ dB
1	32 (-1; -5)	31	0	-1	0	0	0	0	-1	-2	-3
2	33 (-1; -5)	32	0	-1	0	0	0	0	-1	-2	-3
3	35 (-1; -5)	34	0	-1	0	0	0	0	-1	-2	-3
4	36 (-2; -5)	35	0	-1	-1	0	0	0	-1	-2	-3
5	37 (-2; -5)	37	0	0	-1	0	-1	0	-1	-2	-3
6	38 (-2; -5)	39	0	0	-1	-1	-1	0	-1	-2	-3
7	39 (-2; -5)	40	0	0	-1	-1	-1	0	-1	-2	-3
8	40 (-2; -5)	41	0	0	-1	-1	-2	-1	-1	-2	-3
9	41 (-2; -5)	42	0	0	-1	-1	-2	-2	-1	-2	-3
10	42 (-2; -5)	43	-1	0	-1	-1	-2	-2	-1	-2	-3
11	42 (-2; -5)	44	-1	0	-1	-1	-2	-2	-1	-2	-3
12	43 (-2; -5)	45	-1	+1	-1	-1	-3	-3	-1	-2	-3
13	44 (-2; -5)	49	-1	+1	-1	-2	-3	-3	-1	-2	-3

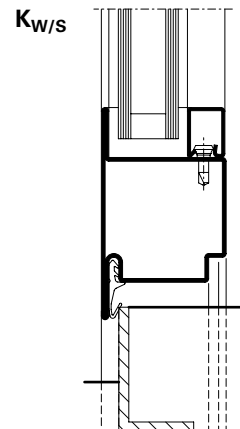
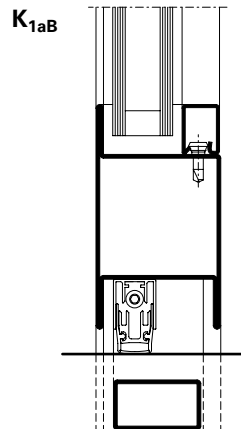
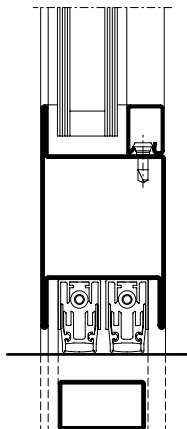

**Schallschutz**

*Der aus der Tabelle A1 abzulesende Wert für die Schalldämmung  $R_{w, Tür}$  beträgt:*

**Isolation phonique**

*La valeur à relever sur le tableau A1 concernant l'isolement contre les sons aériens  $R_{w, Porte}$  est la suivante:*

**Sound insulation**

*The value taken from table A1 for the sound insulation  $R_{w, Door}$  is:*

$$R_{w, Tür} = R_w + K_S + K_{FV} + K_{Nass} + K_{1aB} + K_{W/S} + K_{Band} + K_{G 0,4} + K_{G 1,8} + K_{G 2,6} + K_{G 3,2} \text{ dB}$$

- $R_w$**  bewertetes Schalldämm-Mass der Türe in Abhängigkeit von der Schalldämmung  $R_{w,P, Glas}$
- $R_{w,P, Glas}$**  bewertetes Schalldämm-Mass der Verglasung (Prüfwert nach ISO 140-3, mit Prüfnachweis einer PÜZ-Stelle). Alternativ können Tabellenwerte nach DIN EN 12758, Abschnitt 6 verwendet werden
- $K_S$**  Korrekturwert für zweiflügelige Türen
- $K_{FV}$**  Korrekturwert für Festverglasungen mit erhöhtem Scheibenanteil
- $K_{Nass}$**  Korrekturwert für Nassverglasung
- $K_{1aB}$**  Korrekturwert für Türen mit einer absenkbaren Bodendichtung
- $K_{Band}$**  Korrekturwert bei Verwendung von Anschlagbändern, die eine Dichtungsebene unterbrechen ( $K_{Band} = - 0,5 \text{ dB pro Band}$ )
- $K_{W/S}$**  Korrekturwert für Türen mit einer Anschlagsschwelle
- $K_{G 0,4}$**  Korrekturwert für Einzelscheiben mit einer Glasfläche  $\leq 0,4 \text{ m}^2$ . Die Korrektur gilt auch für Konstruktionen mit glasteilenden Sprossen.
- $K_{G 1,8}$**  Korrekturwert für Einzelscheiben mit einer Glasfläche  $\geq 1,8 \text{ m}^2$
- $K_{G 2,6}$**  Korrekturwert für Einzelscheiben mit einer Glasfläche  $\geq 2,6 \text{ m}^2$
- $K_{G 3,2}$**  Korrekturwert für Einzelscheiben mit einer Glasfläche  $\geq 3,2 \text{ m}^2$

- $R_w$**  Mesure d'isolement contre les sons aériens des portes évaluée suivant l'isolement phonique  $R_{w,P, Glas}$
- $R_{w,P, Glas}$**  Cote d'isolement acoustique du vitrage évalué (valeur contrôlée selon ISO 140-3 avec certificat d'un bureau de contrôle, de surveillance ou de certification). Il est également possible d'utiliser les valeurs selon le tableau DIN EN 12758, section 6
- $K_S$**  Valeur de correction pour portes à deux vantaux
- $K_{FV}$**  Valeur de correction pour vitrages fixes à fort pourcentage de vitre
- $K_{Nass}$**  Valeur de correction pour vitrage avec mastic
- $K_{1aB}$**  Valeur de correction pour portes avec un joint seuil automatique
- $K_{Band}$**  Valeur corrective en cas d'utilisation de paumelles qui interrompent un plan d'étanchéité ( $K_{Band} = - 0,5 \text{ dB par paumelle}$ )
- $K_{W/S}$**  Valeur de correction pour portes avec un seuil de butée
- $K_{G 0,4}$**  Valeur de correction pour vitres individuelles avec une surface vitrée  $\leq 0,4 \text{ m}^2$ . La correction s'applique aussi aux constructions à meneaux séparant les vitres.
- $K_{G 1,8}$**  Valeur de correction pour vitres individuelles avec surface vitrée  $\geq 1,8 \text{ m}^2$
- $K_{G 2,6}$**  Valeur de correction pour vitres individuelles avec surface vitrée  $\geq 2,6 \text{ m}^2$
- $K_{G 3,2}$**  Valeur de correction pour vitres individuelles avec surface vitrée  $\geq 3,2 \text{ m}^2$

- $R_w$**  Airborne sound reduction index of doors depending on the sound insulation  $R_{w,P, Glas}$
- $R_{w,P, Glas}$**  Airborne sound reduction index (test value in accordance with ISO 140-3, with a test certificate from a recognised testing, inspection or certification body). Alternatively, the tabulated values in DIN EN 12758, Section 6 may be used
- $K_S$**  Correction value for double-leaf doors
- $K_{FV}$**  Correction value for fixed glazing with increased proportion of pane
- $K_{Nass}$**  Correction value for glazing with sealing
- $K_{1aB}$**  Correction value for doors with a threshold gasket that can be lowered
- $K_{Band}$**  Correction value when using hinges that interrupt a sealing plane ( $K_{Band} = - 0.5 \text{ dB per hinge}$ )
- $K_{W/S}$**  Correction value for doors with a rebate threshold
- $K_{G 0,4}$**  Correction value for single panes with a glass area  $\leq 0,4 \text{ m}^2$ . The correction also applies to buildings with glazing bars
- $K_{G 1,8}$**  Correction value for single panes with a glass area  $\geq 1,8 \text{ m}^2$
- $K_{G 2,6}$**  Correction value for single panes with a glass area  $\geq 2,6 \text{ m}^2$
- $K_{G 3,2}$**  Correction value for single panes with a glass area  $\geq 3,2 \text{ m}^2$