

Janisol Arte 66

Filigrane wärmegeämmte Fenster und Verglasungen aus Stahl

Janisol Arte 66

Fenêtres et vitrages fixes en acier fins à rupture de pont thermique

Janisol Arte 66

Thermally insulated slim windows and fixed lights in steel

Inhaltsverzeichnis		Janisol Arte 66	
Sommaire		Janisol Arte 66	
Content		Janisol Arte 66	

Systemübersicht	Sommaire du système	Summary of system	2
Merkmale	Caractéristiques	Characteristics	
Leistungseigenschaften	Caractéristiques de performance	Performance characteristics	
Typenübersicht	Sommaire des types	Summary of types	

Profilsortiment	Assortiment de profilé	Range of profiles	8
------------------------	-------------------------------	--------------------------	----------

Beispiele	Exemples	Examples	14
Schnittpunkte	Coupes de détails	Section details	
Konstruktionsdetails	Détails de construction	Construction details	
Anschlüsse am Bau	Raccords au mur	Attachment to structure	

Leistungseigenschaften	Caractéristiques de performance	Performance characteristics	32
-------------------------------	--	------------------------------------	-----------

Alle Ausführungen dieser Dokumentation haben wir sorgfältig und nach bestem Wissen zusammengestellt. Wir können aber keine Verantwortung für die Benutzung der vermittelten Vorschläge und Daten übernehmen. Wir behalten uns technische Änderungen ohne Vorankündigung vor.
Aktuelle Version auf www.jansen.com

Nous avons apporté le plus grand soin à l'élaboration de cette documentation. Cependant, nous déclinons toute responsabilité pour l'utilisation faite de nos propositions et de nos données.
Nous nous réservons le droit de procéder à des modifications techniques sans préavis.
Version actuelle sur www.jansen.com

All the information contained in this documentation is given to the best of our knowledge and ability. However, we decline all responsibility for the use made of these suggestions and data.
We reserve the right to effect technical modifications without prior warning.
Current version available at www.jansen.com

Merkmale
Caractéristiques
Characteristics

Janisol Arte 66
Janisol Arte 66
Janisol Arte 66

- Wärmegeädämmtes Stahlsystem für Fenster und Festverglasungen
- Bautiefe 60/66 mm, Fensterflügel 70 mm
- Schmale Ansichtsbreiten: Fenstersprossen 40 mm Rahmen inkl. Flügel ab 53 mm Stulppartie 76 mm
- Ein- und zweiflüglige Dreh- und Drehkippenfenster und Kippenfenster nach innen öffnend
- Dreh- und Drekippen-Fensterflügel bis 2300 mm Höhe
- Flügelgewichte bis 180 kg
- Füllelementstärken von 15 bis 44 mm, Glaseinbau mittels Trocken- oder Nassverglasung
- Systemprüfungen nach Produktnorm EN 14351-1
- Profil-Verbundtechnik nach EN 14024 und DIN 18056 geprüft
- Geeignet für Pulver- und Nasslackbeschichtungen
- Oberfläche ZF 100 für ein optimiertes Schweissverhalten
- Système en acier à rupture de pont thermique pour fenêtres et vitrages fixes
- Profondeur de montage 60/66 mm, vantail de fenêtre 70 mm
- Fines largeurs de face: Meneau de fenêtre 40 mm Cadre avec vantail à partir de 53 mm Partie tête 76 mm
- Fenêtres ouvrant à la française et oscillo-battantes à un et deux vantaux et fenêtres à soufflet à ouverture vers l'intérieur
- Vantaux à la française et oscillo-battants jusqu'à 2300 mm hauteur
- Poids de vantail jusqu'à 180 kg
- Éléments de remplissage de 15 à 44 mm d'épaisseur, montage du vitrage à sec ou au silicone
- Contrôles des systèmes selon la norme produit EN 14351-1
- Technique d'assemblage de profilés contrôlée selon EN 14024 et DIN 18056
- Convient aux revêtements par poudre ou peinture liquide
- Surface ZF 100 pour un comportement au soudage optimisé
- Thermally insulated steel system for windows and fixed glazing
- Basic depth 60/66 mm, window vent 70 mm
- Narrow face widths: Window sash bars 40 mm Frame including vent from 53 mm Double vent assembly 76 mm
- Single and double-vent side-hung and turn/tilt windows and bottom-hung windows, inward-opening
- Side-hung and turn/tilt window vents up to 2300 mm height
- Vent weights up to 180 kg
- Infill unit thicknesses from 15 to 44 mm, glazing installed by means of dry or wet glazing
- System tests in accordance with the product standard EN 14351-1
- Profile bonding technology tested in accordance with EN 14024 and DIN 18056
- Suitable for powder and wet paint coating
- ZF 100 surface finish for optimised welding characteristics

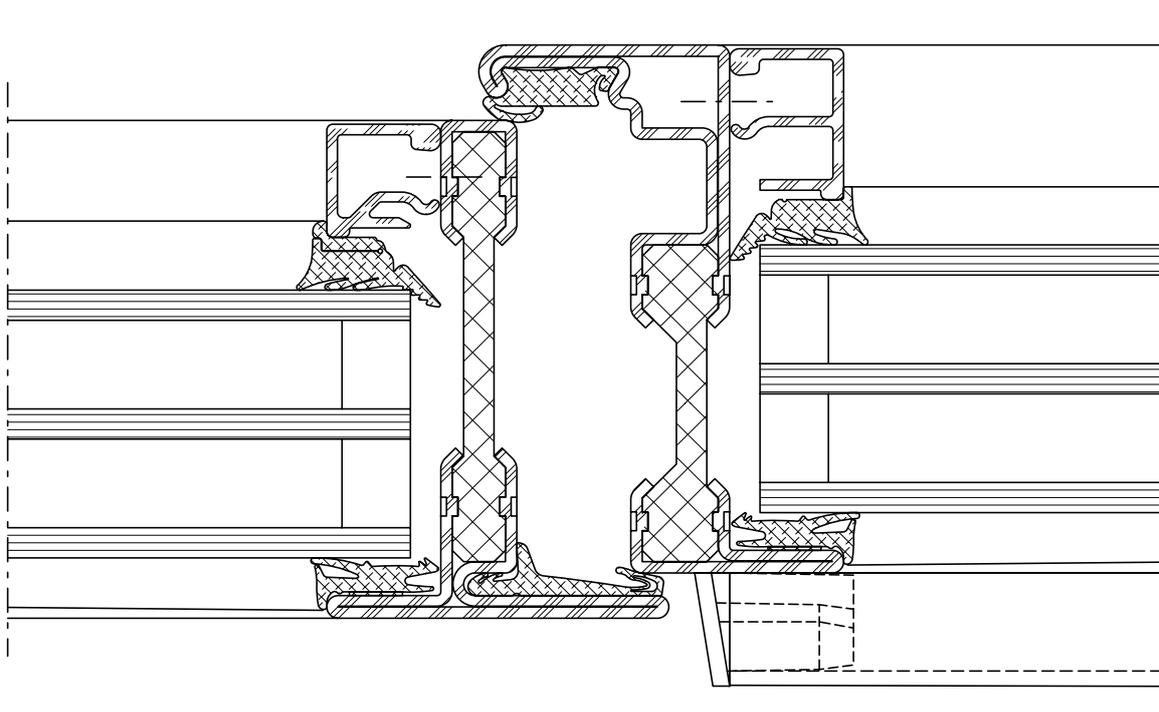

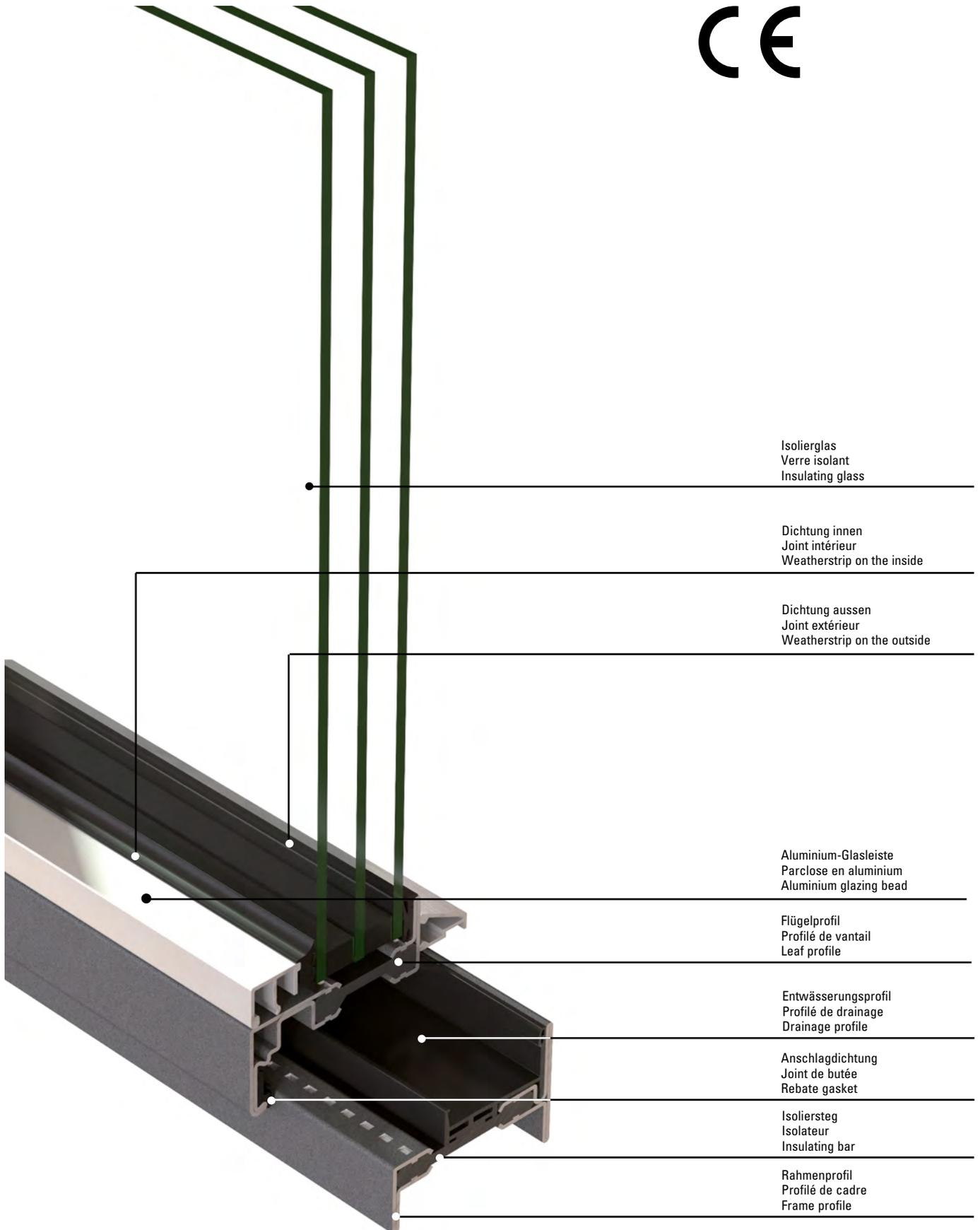

Norm	Eigenschaft Caractéristique Characteristic	Klassifizierung / Wert Classification / Valeur Classification / Value												
		npd		C1 (400)		C2 (800)		C3 (1200)		C4 (1600)		C5 (2000)		
 EN 12210	Widerstandsfähigkeit bei Windlast Résistance à la pression du vent Resistance to wind load	npd		C1 (400)		C2 (800)		C3 (1200)		C4 (1600)		C5 (2000)		
 EN 12208	Schlagregendichtheit Étanchéité à la pluie battante Watertightness	npd		1A (0)	2A (50)	3A (100)	4A (150)	5A (200)	6A (250)	7A (300)	8A (450)	9A (600)	Exxx (>750)	
 EN ISO 10140	Schalldämmung R_w (C , C_{tr}) (dB) Isolation phonique R_w (C , C_{tr}) (dB) Sound insulation R_w (C , C_{tr}) (dB)	npd		bis R_w 47 dB (-2; -7) jusqu'à R_w 47 dB (-2; -7) up to R_w 47 dB (-2; -7)										
 EN ISO 10077-2	Wärmedurchgangskoeffizient U_f (W/(m ² ·K)) Transmission thermique U_f (W/(m ² ·K)) Thermal production U_f (W/(m ² ·K))	npd		ab 1,6 W/m ² ·K à partir de 1,6 W/m ² ·K from 1,6 W/m ² ·K										
 EN 12207	Luftdurchlässigkeit Perméabilité à l'air Air permeability	npd		1 (150)		2 (300)		3 (600)		4 (600)				
 EN 14351-1	Tragfähigkeit von Sicherheitsvorrichtungen Capacité portante des dispositifs de sécurité Load-bearing capacity of safety devices	npd		Anforderung erfüllt Exigence remplie Requirement satisfied										
 EN 13115	Mechanische Festigkeit Résistance mécanique Mechanical strength	npd		1		2		3		4				
 EN 13115	Bedienkräfte Forces de manœuvre Operating forces	npd		0				1		2				
 EN 13049	Stoßfestigkeit Résistance aux chocs Impact resistance	npd		1		2		3		4		5		
 EN 14024	Metallprofile mit thermischer Trennung Profils en métal. avec rupture de pont thermique Metal profiles with thermal barrier	CW / TC2 / A												
 DIN 18008-4	Vorgefertigte absturzsichernde Verglasung Vitrage anti-chutes préfabriqué Prefabricated glazing suitable for safety barrier loading								Anhang D.1.2 erfüllt Annexe D.1.2 satisfaite Appendix D.1.2 fulfilled					

npd = keine Leistung festgestellt
(no performance determined)

npd = aucune performance
déterminée
(no performance determined)

npd = no performance determined

Jansen Docu Center

Die Plattform zum effizienten Arbeiten mit Jansen Dokumentationen. Im Jansen Docu Center stehen alle Produktinformationen jederzeit digital in der aktuellsten Version zur Verfügung: von Architekten-Informationen über Bestell- und Fertigungskatalogen bis hin zu Anleitungen und Prospekten sowie Videos.

Die Inhalte können einfach und schnell aufgerufen werden. Ein für den Anwender komfortables papierloses Arbeiten, das zahlreiche Vorteile bietet.

Download CAD Daten

DXF

DWG

Sie können die Zeichnungen in den Formaten DXF und/oder DWG herunterladen. Klicken Sie auf das entsprechende Icon und der Download erfolgt.

Die Hinweise «Artikelbibliothek/Türbeschläge/Fensterbeschläge» bedeuten, dass Sie mit einem Klick die gesamte Artikelbibliothek des entsprechenden Systems herunterladen (Profile, Beschläge, Glasleisten, Zubehör etc.).

Info und Beratung

Gerne beraten wir Sie persönlich und stehen Ihnen bei Fragen zur Verfügung. Bitte schreiben Sie uns Ihre Anliegen an: info@jansen.com

Jansen Docu Center

La plate-forme pour travailler efficacement avec les documentations Jansen. Le Jansen Docu Center met à votre disposition les informations sur les produits, en format numérique et dans une version actualisée: des catalogues de commande et de fabrication aux instructions et prospectus, en passant par les informations destinées aux architectes et vidéos.

Les contenus sont facilement et rapidement accessibles. Une manière de travailler confortable et offrant de nombreux avantages.

Télécharger fichiers DAO

DXF

DWG

Vous pouvez télécharger les dessins aux formats DXF et/ou DWG. Cliquez sur l'icône correspondante et le téléchargement s'effectuera.

Les indications «Bibliothèque des articles/Ferures de porte/Ferrures de fenêtres» signifie que vous téléchargez la totalité de la bibliothèque des articles du système donné (profilés, ferrures, parclozes, accessoires etc.).

Info et conseils

Nous vous conseillerons volontiers individuellement et sommes à votre disposition si vous avez des questions à poser. Veuillez nous envoyer votre requête à: info@jansen.com

Jansen Docu Center

The platform for working efficiently with Jansen documentation. The latest version of all the product information is available digitally at any time in the Jansen Docu Center – from order and fabrication manuals to architect information, instructions and brochures and videos.

The content can be retrieved quickly and easily. The user can work conveniently without paper, which has numerous benefits.

Download CAD files

DXF

DWG

You can download the drawings in DXF and/or DWG format. Click on the relevant icon to begin the download.

The items «Article library/Door fittings/Window fittings» means that you download the entire article library for the corresponding system with one click (profiles, fittings, glazing beads, accessories etc.).

Information and advice

We would be delighted to provide you with advice in person and are available to answer any questions you may have. Please write to us with your queries at: info@jansen.com

Technische Daten**Caractéristiques techniques****Technical data**

Janisol Arte 66

Janisol Arte 66

Janisol Arte 66

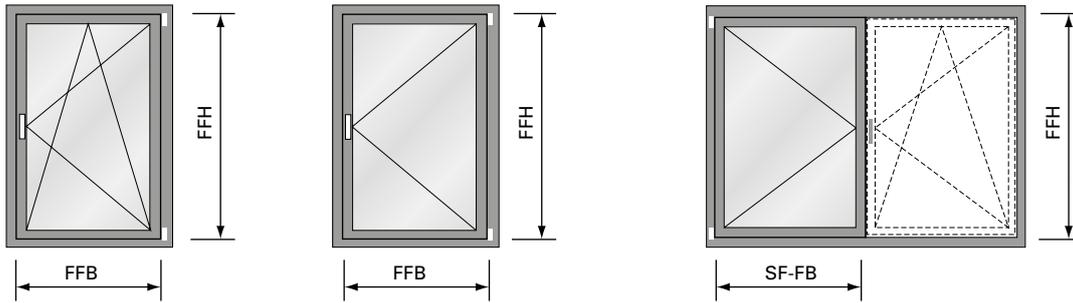
**Flügelgrößen***Drehkipp-, Drehfenster und Stulpfenster:*

Max.	FFH = 2300 mm
	FFB = 1400 mm
Min.	FFH = 470 mm
	FFB = 480 mm

Max. Gewicht:	180 kg
FFB/FFH:	≤ 2
max. Fläche:	2,3 m ²

Grandeurs du vantail*fenêtre oscillo-battante, à la française et fenêtre à deux vantaux:*

Max.	FFH = 2300 mm
	FFB = 1400 mm
Min.	FFH = 470 mm
	FFB = 480 mm

Poids max.:	180 kg
FFB/FFH:	≤ 2
Surface max:	2,3 m ²

Size of vents*turn/tilt, side-hung and double-vent windows:*

Max.	FFH = 2300 mm
	FFB = 1400 mm
Min.	FFH = 470 mm
	FFB = 480 mm

Max. weight:	180 kg
FFB/FFH:	≤ 2
max. surface:	2,3 m ²

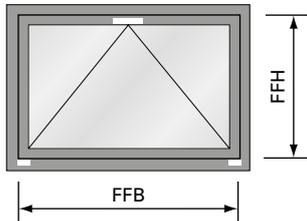
**Flügelgröße***Kipp-Fenster:*

Max.	FFH = 2300 mm
	FFB = 2300 mm
Min.	FFH = 600 mm
	FFB = 445 mm

Max. Gewicht:	80 kg
---------------	-------

Grandeur du vantail*fenêtre à soufflet:*

Max.	FFH = 2300 mm
	FFB = 2300 mm
Min.	FFH = 600 mm
	FFB = 445 mm

Poids max.:	80 kg
-------------	-------

Size of vent*bottom-hung window:*

Max.	FFH = 2300 mm
	FFB = 2300 mm
Min.	FFH = 600 mm
	FFB = 445 mm

Max. weight:	80 kg
--------------	-------

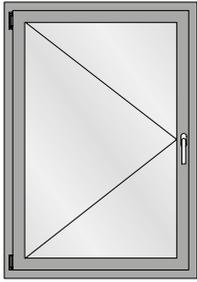

Drehflügel
 Fenêtre à la française
 Side-hung window

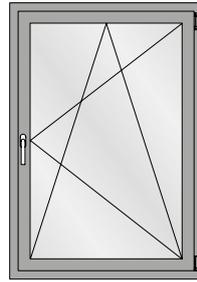

Drehkipp-Flügel
 Vantail oscillo-battant
 Turn/tilt window

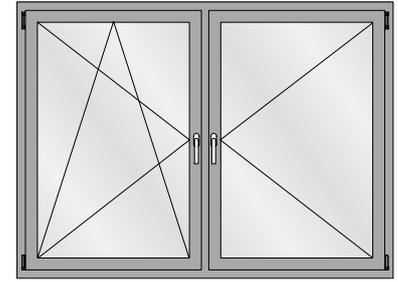

Drehkipp/Drehflügel (mit Pfosten)
 Vantail oscillo-battant/fenêtre à la française
 (avec montant)
 Side-hung/turn/tilt window (with mullion)

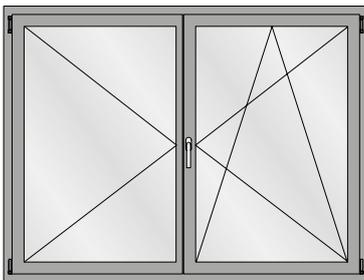

Stulpfenster
 Fenêtre à deux vantaux
 Double leaf window

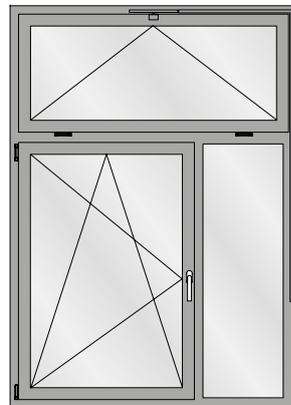

Fenster Drehkipp mit Oberlicht
 Vantail oscillo-battant avec imposte
 Window, turn/tilt with top light

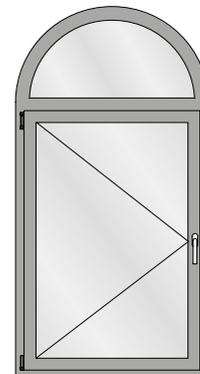

Einflügeliges Fenster mit Rundbogen-Oberlicht
 Fenêtre à la française avec imposte demi-rond
 Side hung window with round arched top light

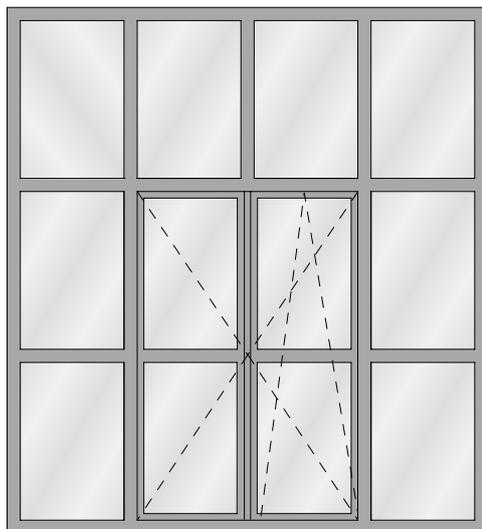

Drehkipp-Flügel mit Festverglasung
 Vantail oscillo-battant avec vitrage fixe et imposte
 Turn/tilt window with fixed lights and top lights

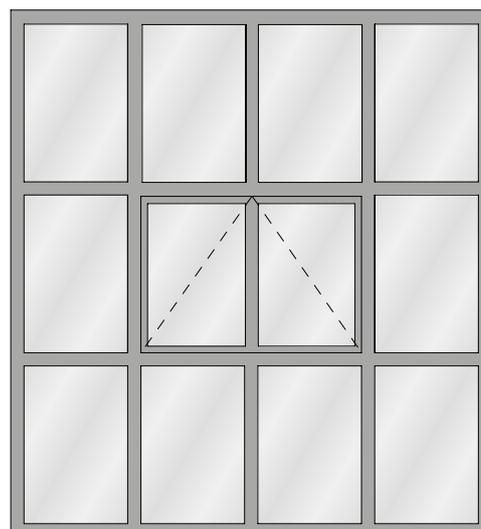

Kippfenster
 Fenêtre à soufflet
 Bottom-hung window

Profile mit Lappen 20 mm
(Rahmen Drehkipp-Fenster)

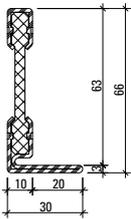

601.630 Z

Profilés avec battue 20 mm
(cadre fenêtre oscillo-battante)

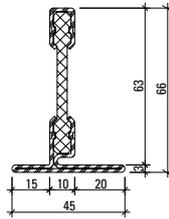

602.630 Z

Profiles with lips, 20 mm
(turn/tilt window frame)

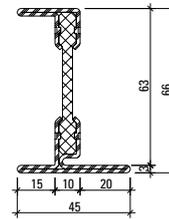

605.630 Z

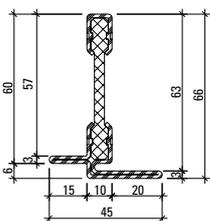

602.631 Z

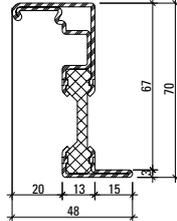

610.900 Z

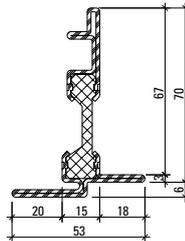

610.901 Z

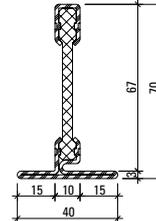

602.611.7 Z

Profile mit Lappen 15 mm
(Festverglasungen)

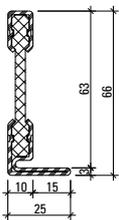

601.612 Z

Profilés avec battue 15 mm
(Vitrages fixes)

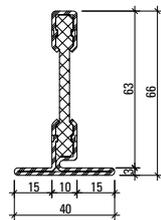

602.613 Z

Profiles with lips 15 mm
(Fixed glazings)

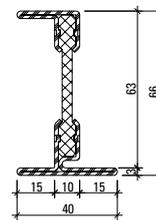

605.612 Z

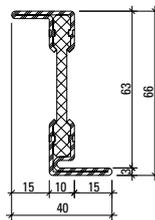

603.612 Z
603.612.01
603.612.09

Werkstoffe

Artikel-Nr.

mit Z = bandverzinkter Stahl

Edelstahl = auf Anfrage

Corten = auf Anfrage

Matériaux

No. d'article

avec Z = bande d'acier zinguée

Acier Inox = sur demande

Corten = sur demande

Materials

Part no.

with Z = strip galvanised steel

Stainless steel = on request

Corten = on request

Profil-Nr.	G kg/m	I _x cm ⁴	W _x cm ³	I _y cm ⁴	W _y cm ³	U m ² /m
601.630 Z	2,276	9,63	2,12	1,37	0,65	0,214
602.630 Z	2,615	10,65	2,20	2,42	1,02	0,243
603.630 Z	2,619	14,84	3,93	2,42	1,02	0,243
605.630 Z	2,958	16,83	4,05	3,19	1,24	0,272
602.631 Z	2,609	10,11	2,14	2,41	1,01	0,242
602.611.7 Z	2,353	11,85	2,35	1,68	0,84	0,241

Profil-Nr.	G kg/m	I _x cm ⁴	W _x cm ³	I _y cm ⁴	W _y cm ³	U m ² /m
601.612 Z	2,159	9,23	2,12	0,83	0,48	0,204
602.613 Z	2,497	10,41	2,20	1,71	0,85	0,233
603.612 Z	2,502	13,98	3,87	1,71	0,85	0,234
605.612 Z	2,840	16,21	4,02	2,35	1,07	0,262
610.900 Z	3,048					0,272
610.901 Z	3,410					0,298

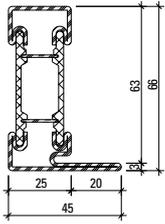

601.632 Z

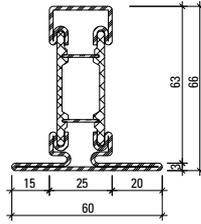

602.632 Z

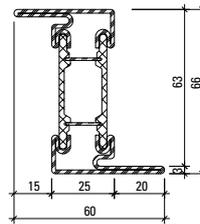

603.632 Z

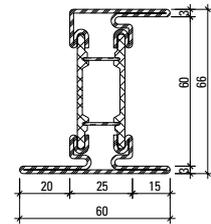

605.632 Z

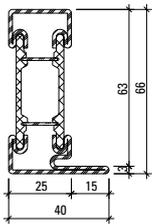

601.645 Z

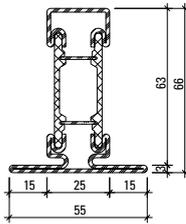

602.645 Z

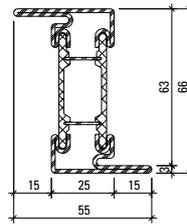

603.645 Z

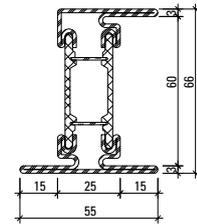

605.645 Z

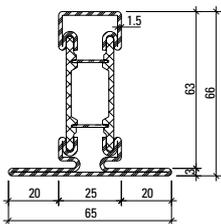

602.633 Z

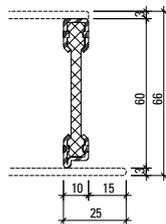

600.612 Z

Werkstoffe

Artikel-Nr.

mit **Z** = bandverzinkter Stahl

Matériaux

No. d'article

avec **Z** = bande d'acier zinguée

Materials

Part no.

with **Z** = strip galvanised steel

Profil-Nr.	G kg/m	I _x cm ⁴	W _x cm ³	I _y cm ⁴	W _y cm ³	U m ² /m
601.632 Z	3,217	16,98	4,21	4,70	1,67	0,249
601.645 Z	3,100	16,29	4,16	3,70	1,52	0,239
602.632 Z	3,701	19,13	4,34	7,15	2,28	0,290
602.645 Z	3,584	18,63	4,31	5,88	2,14	0,280
603.632 Z	3,700	22,63	6,61	7,16	2,28	0,290

Profil-Nr.	G kg/m	I _x cm ⁴	W _x cm ³	I _y cm ⁴	W _y cm ³	U m ² /m
603.645 Z	3,583	21,56	6,53	5,88	2,14	0,280
605.632 Z	4,184	26,12	6,83	9,02	2,68	0,331
605.645 Z	4,067	25,31	6,78	7,54	2,53	0,321
602.633 Z	3,819	19,58	4,37	8,53	2,62	0,300
600.612 Z	1,292	4,39	1,44	0,14	0,26	0,150

Profile Janisol Arte 2.0
(Lappen 15 mm)

Profilés Janisol Arte 2.0
(Lappen 15 mm)

Profiles Janisol Arte 2.0
(Lappen 15 mm)

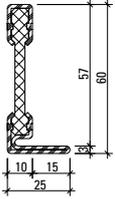

601.611 Z
601.611.01
601.611.09

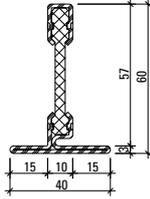

602.611 Z
602.611.01
602.611.09

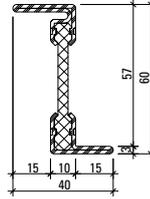

603.611 Z
603.611.01
603.611.09

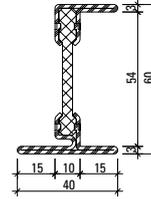

605.611 Z
605.611.01
605.611.09

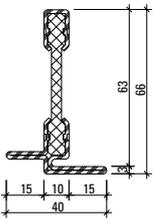

602.612 Z
602.612.01
602.612.09

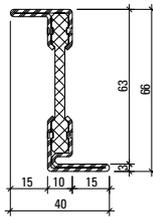

603.612 Z
603.612.01
603.612.09

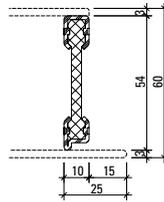

600.609 Z

Artikelbibliothek
 Bibliothèque des articles
 Article library

DXF **DWG**

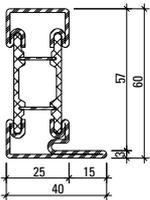

601.615 Z
601.615.09

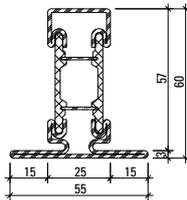

602.615 Z
602.615.01
602.615.09

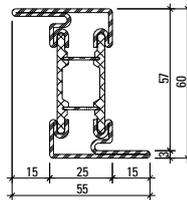

603.615 Z
603.615.09

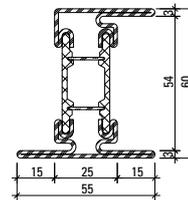

605.615 Z
605.615.09

Stirnseitige Kennzeichnung
 Edelstahl (01) = Blau
 Corten (09) = Grün

Marquage en face avant
 Acier inox (01) = Bleu
 Corten (09) = Vert

Labelling on the front
 Stainless steel (01) = Blue
 Corten (09) = Green

Profil-Nr.	G kg/m	I _x cm ⁴	W _x cm ³	I _y cm ⁴	W _y cm ³	U m ² /m
601.611 Z	1,930	7,31	1,85	0,78	0,46	0,192
602.611 Z	2,269	11,85	2,35	1,68	0,84	0,241
603.611 Z	2,273	11,13	3,47	1,68	0,84	0,222
605.611 Z	2,612	13,04	3,60	2,31	1,05	0,251
602.612 Z	2,491	9,75	2,11	1,71	0,85	0,232
603.612 Z	2,502	13,98	3,87	1,71	0,85	0,234

Profil-Nr.	G kg/m	I _x cm ⁴	W _x cm ³	I _y cm ⁴	W _y cm ³	U m ² /m
600.609 Z	1,242	3,39	1,23	0,14	0,26	0,138
601.615 Z	3,020	12,93	3,64	3,70	1,52	0,227
602.615 Z	3,516	14,85	3,79	5,88	2,14	0,268
603.615 Z	3,515	17,23	5,74	5,88	2,14	0,268
605.615 Z	3,999	20,27	5,97	7,53	2,53	0,309

Profile Janisol Arte 2.0
(Lappen 15 mm)

Profilés Janisol Arte 2.0
(Lappen 15 mm)

Profiles Janisol Arte 2.0
(Lappen 15 mm)

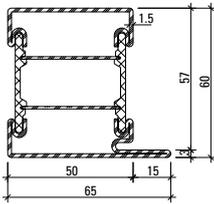

601.616 Z

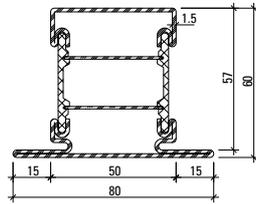

602.616 Z

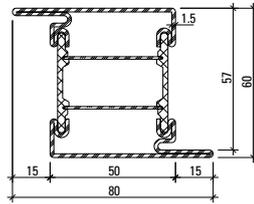

603.616 Z

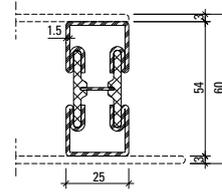

600.008 Z

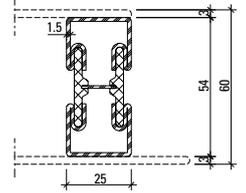

600.008 Z

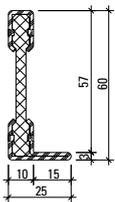

601.610
601.610 Z
601.610.01
601.610.09

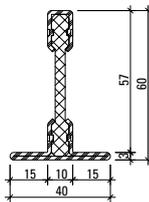

602.610
602.610 Z
602.610.01
602.610.09

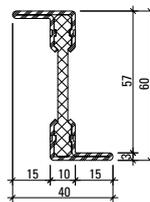

603.610
603.610 Z
603.610.01
603.610.09

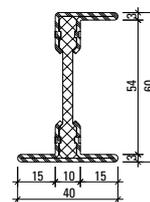

605.610
605.610 Z
605.610.01
605.610.09

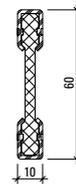

600.610 Z

Werkstoffe

Artikel-Nr.

ohne Zusatz = blank

mit Z = bandverzinkter Stahl

mit 01 = Edelstahl, blank,
Werkstoff 1.4401
(AISI 316)

mit 09 = Stahl KB DOCOL 355W
(Corten)

Matériaux

No. d'article

sans supplément = brut

avec Z = bande d'acier zinguée

avec 01 = acier Inox, brut,
matériau 1.4401
(AISI 316)

avec 09 = acier KB DOCOL 355W
(Corten)

Materials

Part no.

without addition = bright

with Z = strip galvanised steel

with 01 = stainless steel, bright,
material 1.4401
(AISI 316)

with 09 = steel KB DOCOL 355W
(Corten)

Profil-Nr.	G kg/m	I _x cm ⁴	W _x cm ³	I _y cm ⁴	W _y cm ³	U m ² /m
601.616 Z	3,746	17,89	5,20	16,30	4,60	0,295
602.616 Z	4,239	20,08	5,33	22,41	5,60	0,318
603.616 Z	4,219	22,02	7,34	22,38	5,59	0,318
601.610	1,875	6,90	1,84	0,75	0,45	0,180
602.610	2,224	8,14	1,95	1,68	0,84	0,208
603.610	2,218	10,30	3,43	1,68	0,84	0,210
605.610	2,530	12,49	3,58	2,31	1,04	0,232
600.610 Z	1,532	4,94	1,65	0,18	0,36	0,151
600.008 Z	2,826	8,12	2,82	2,57	5,06	0,170
600.007 Z	3,429	12,46	4,33	13,50	5,40	0,220

**Gewichte für
Edelstahlprofile
Poids pour profilés
en acier Inox
Weights for
stainless steel profiles**

601.611.01	= 1,964 kg/m
602.611.01	= 2,311 kg/m
603.611.01	= 2,316 kg/m
605.611.01	= 2,663 kg/m
602.612.01	= 2,536 kg/m
603.612.01	= 2,548 kg/m
602.615.01	= 3,517 kg/m
601.610.01	= 1,906 kg/m
602.610.01	= 2,263 kg/m
603.610.01	= 2,258 kg/m
605.610.01	= 2,608 kg/m

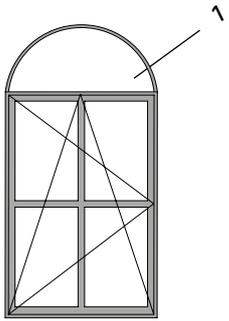

1.0

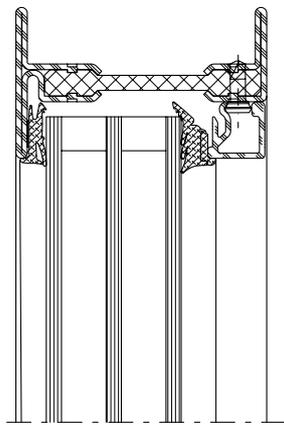

Profil Profilé Profile	Min. Radius Rayon min. Min. radius R
------------------------------	---

	450 mm
601.612	450 mm

	450 mm
602.613	450 mm

Profil Profilé Profile	Min. Radius Rayon min. Min. radius R
------------------------------	---

	450 mm
603.612	450 mm
603.612.09	450 mm

	450 mm
605.612	450 mm

Bogenfenster
Fenêtres cintrées
Arched windows

Janisol Arte 66
 Janisol Arte 66
 Janisol Arte 66

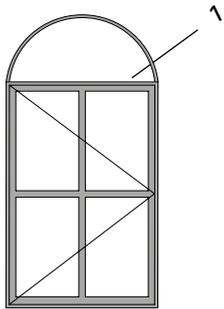

1.0

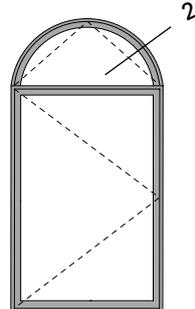
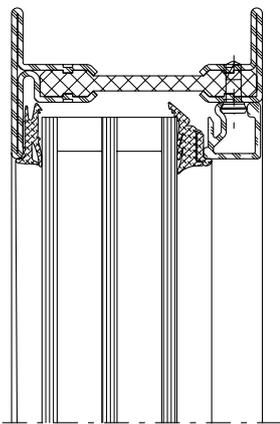

2.0

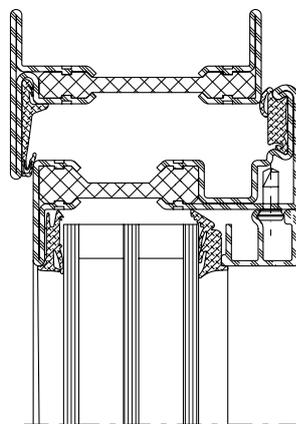

Profil	Min. Radius
Profilé	Rayon min.
Profile	Min. radius
	R

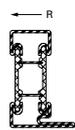

601.632 Z
601.645 Z

Profil	Min. Radius
Profilé	Rayon min.
Profile	Min. radius
	R

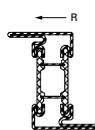

603.632 Z
603.645 Z

Profil	Min. Radius
Profilé	Rayon min.
Profile	Min. radius
	R



405.030	440 mm
405.031	440 mm
405.032	440 mm
405.033	440 mm

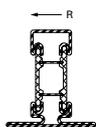

602.632 Z
602.645 Z
602.633 Z

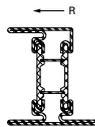

605.632 Z
605.645 Z

Biegeradien auf Anfrage!
Rayons de courbure sur demande!
Bending radii on request!

Schnittpunkte nach innen öffnend
Coupe de détails ouvrant vers l'intérieur
Section details opening inwards

Janisol Arte 66
 Janisol Arte 66
 Janisol Arte 66

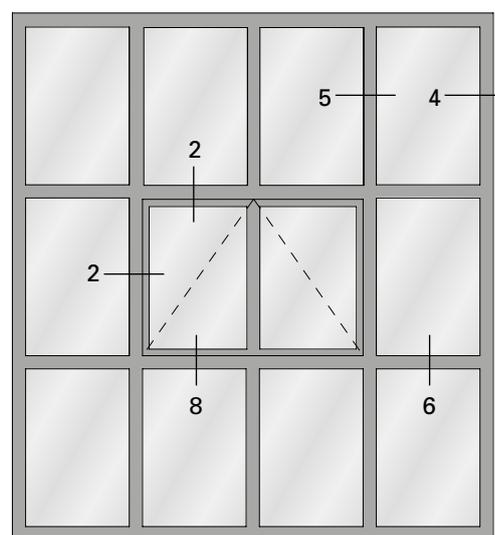
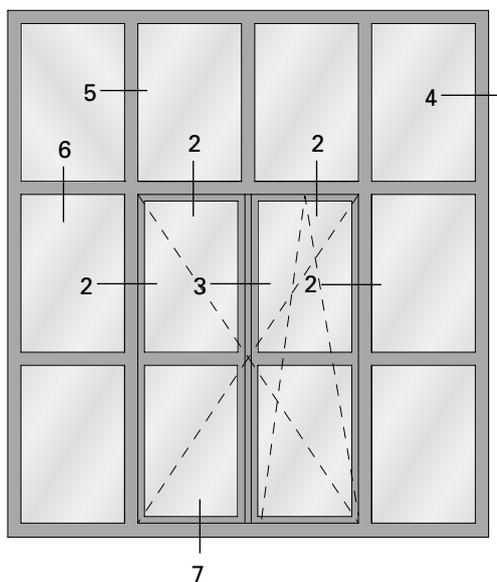
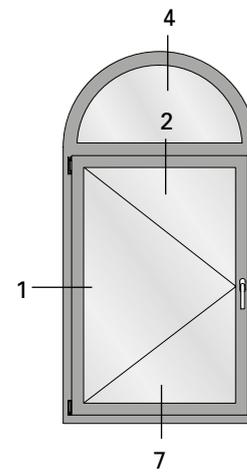
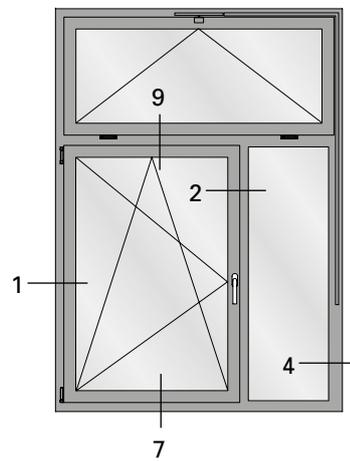
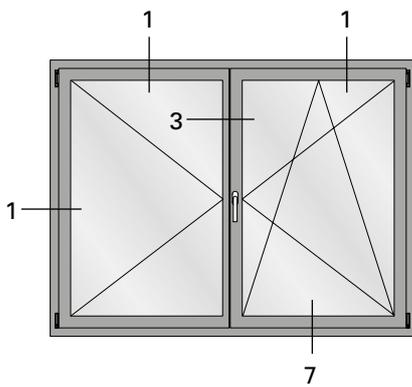
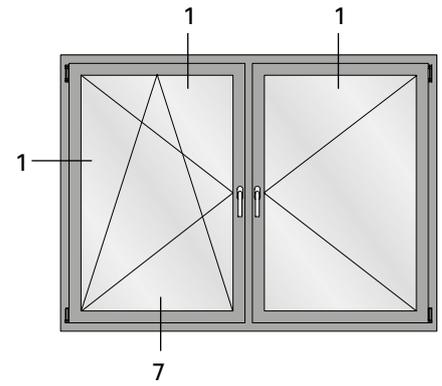
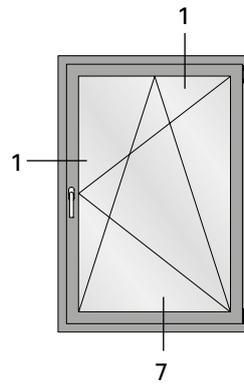
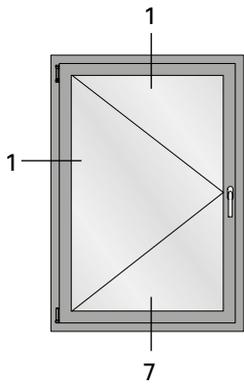

Schnittpunkte nach innen öffnend im Massstab 1:1
Coupe de détails ouvrant vers l'intérieur à l'échelle 1:1
Section details opening inwards on scale 1:1

Janisol Arte 66
Janisol Arte 66
Janisol Arte 66

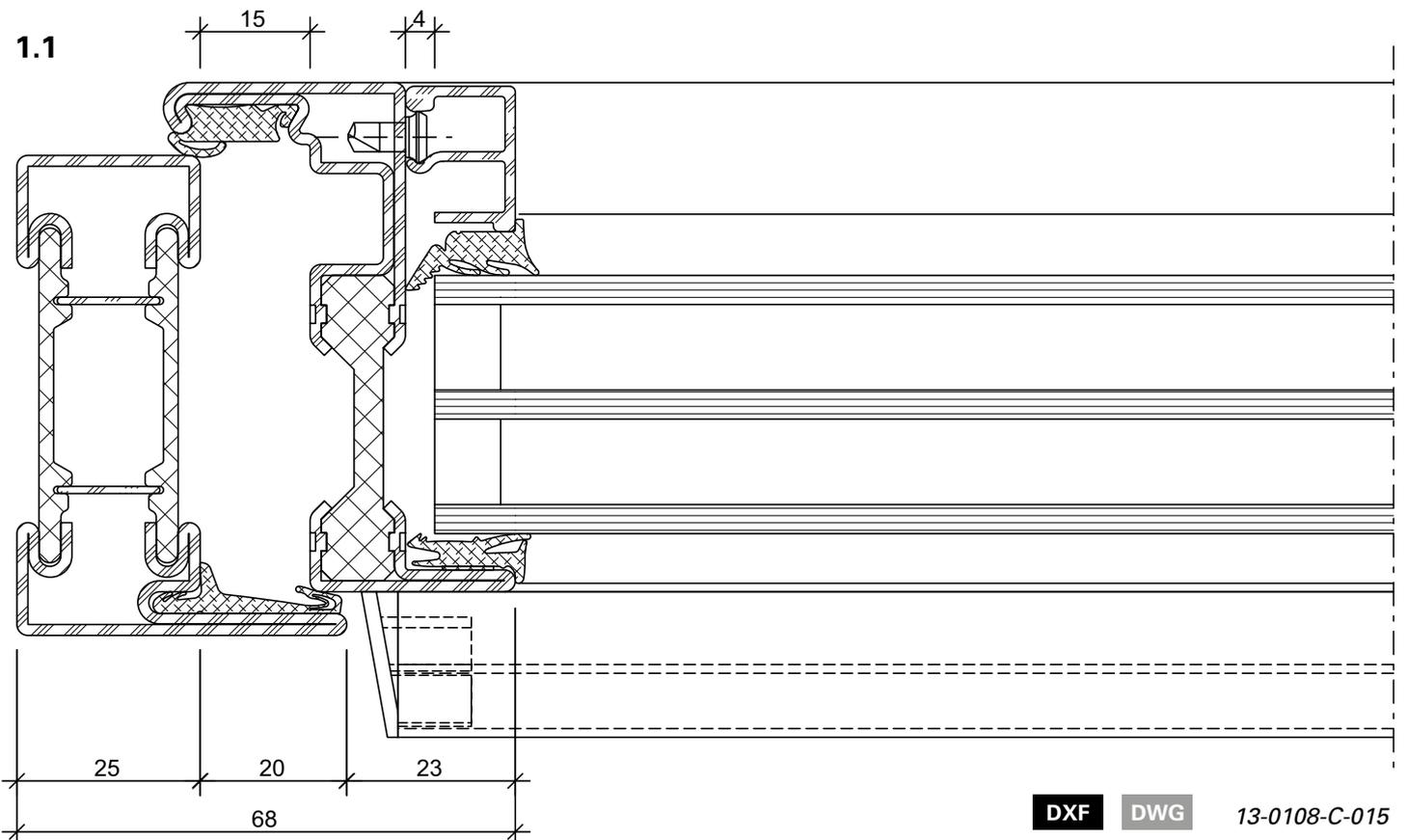
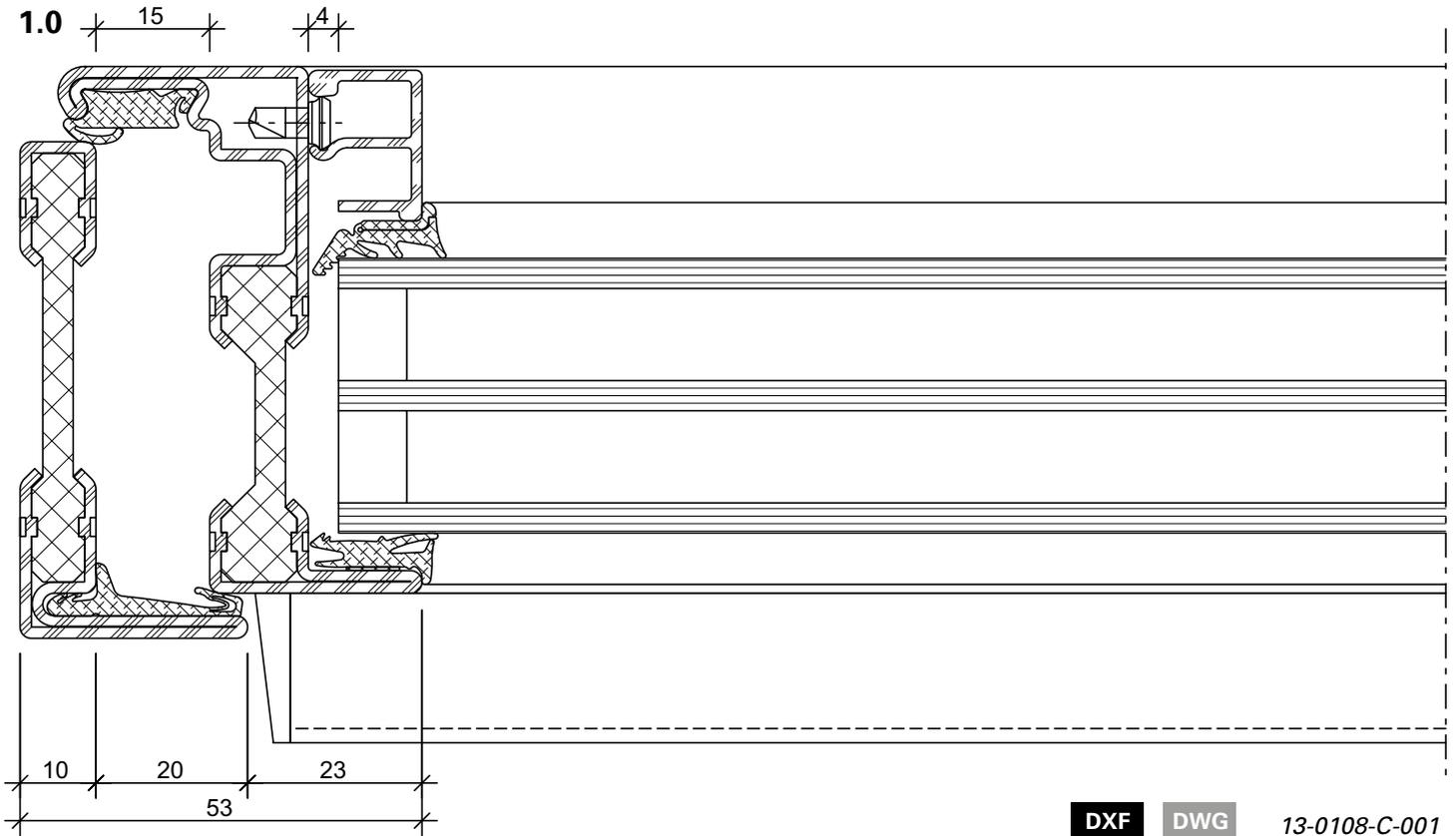

Schnittpunkte nach innen öffnend im Massstab 1:1
Coupe de détails ouvrant vers l'intérieur à l'échelle 1:1
Section details opening inwards on scale 1:1

Janisol Arte 66
Janisol Arte 66
Janisol Arte 66

3.0

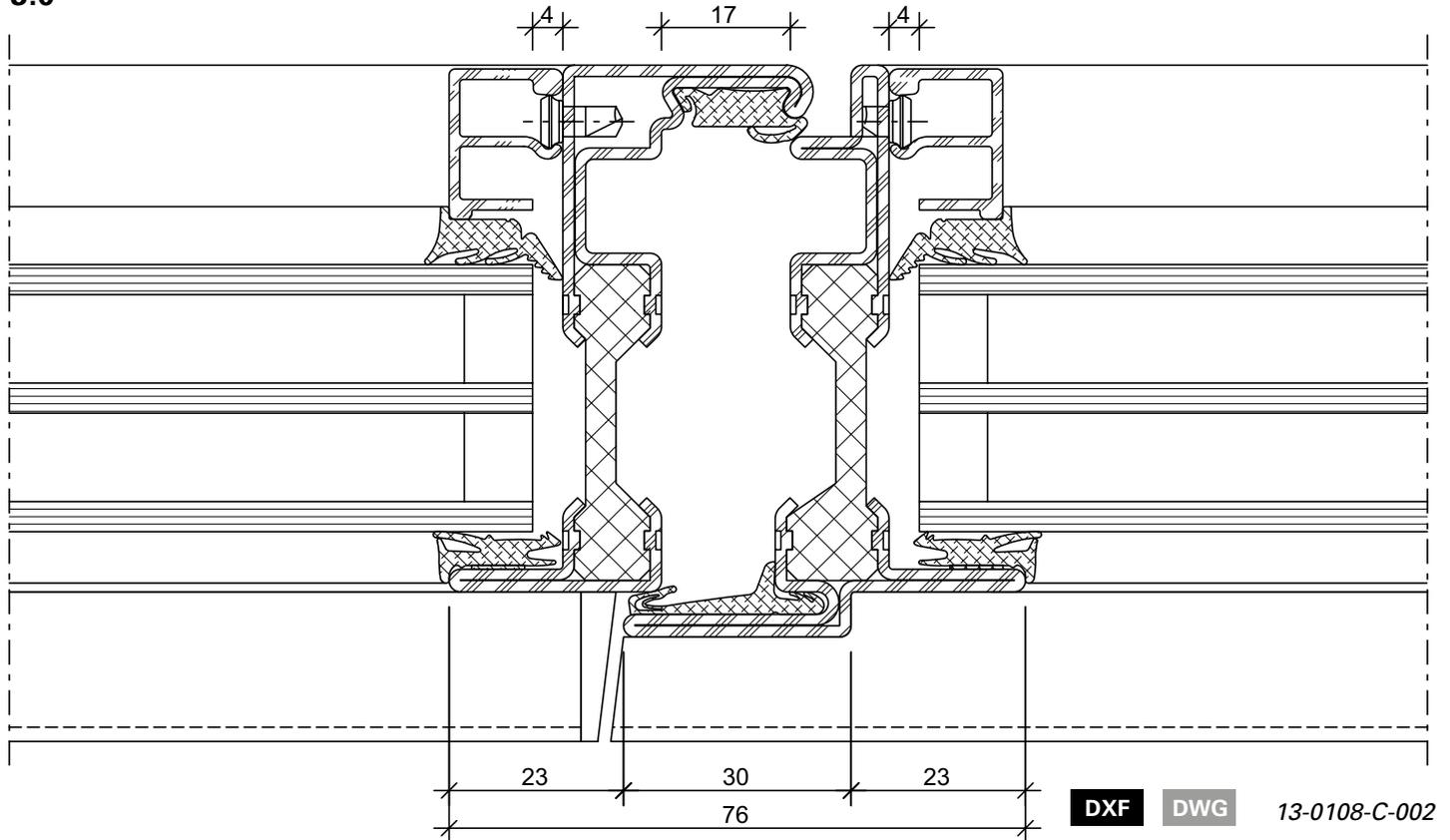

Schnittpunkte nach innen öffnend im Massstab 1:1
Coupe de détails ouvrant vers l'intérieur à l'échelle 1:1
Section details opening inwards on scale 1:1

Janisol Arte 66
Janisol Arte 66
Janisol Arte 66

2.0

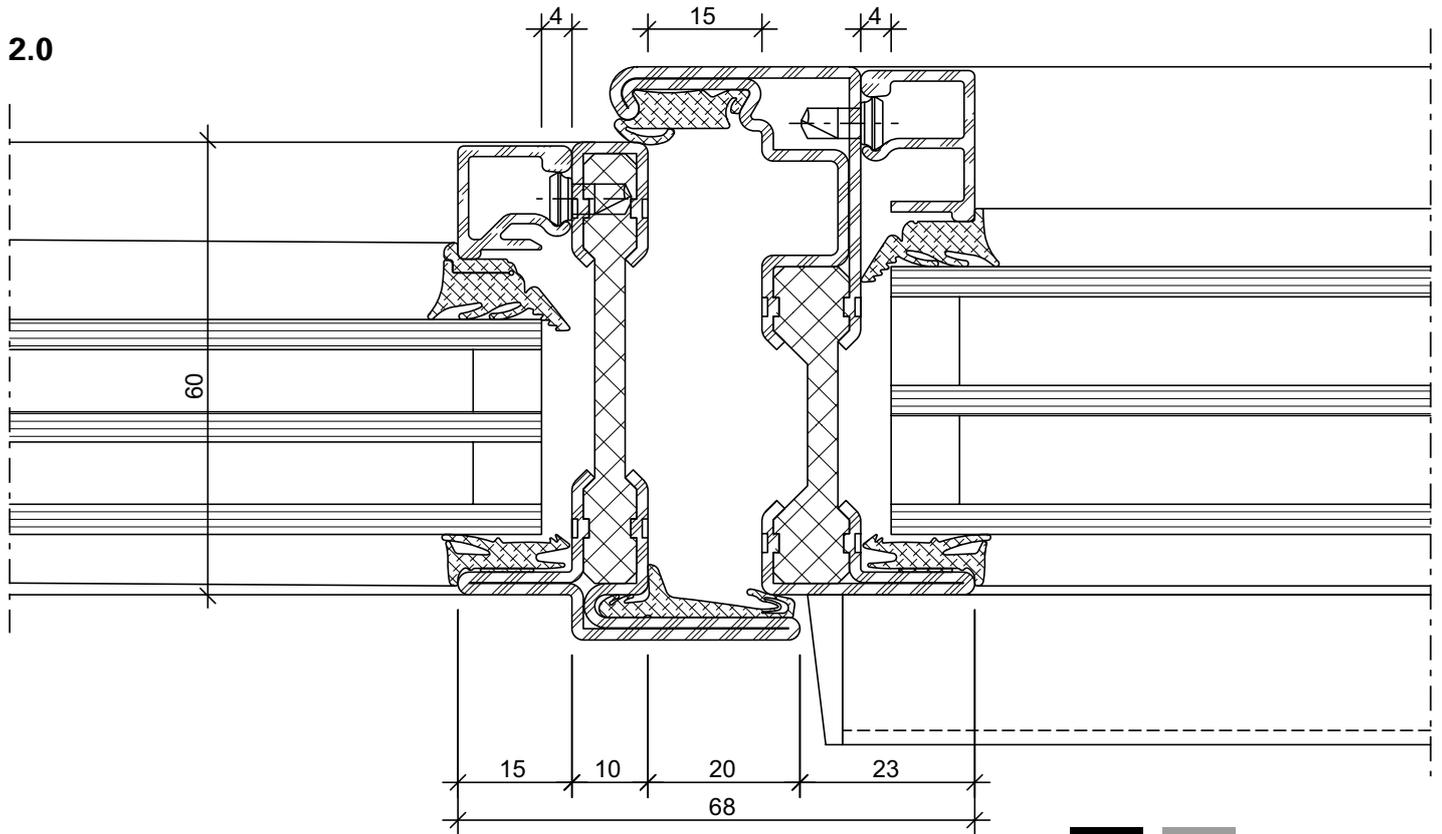

DXF

DWG

13-0108-C-003

2.1

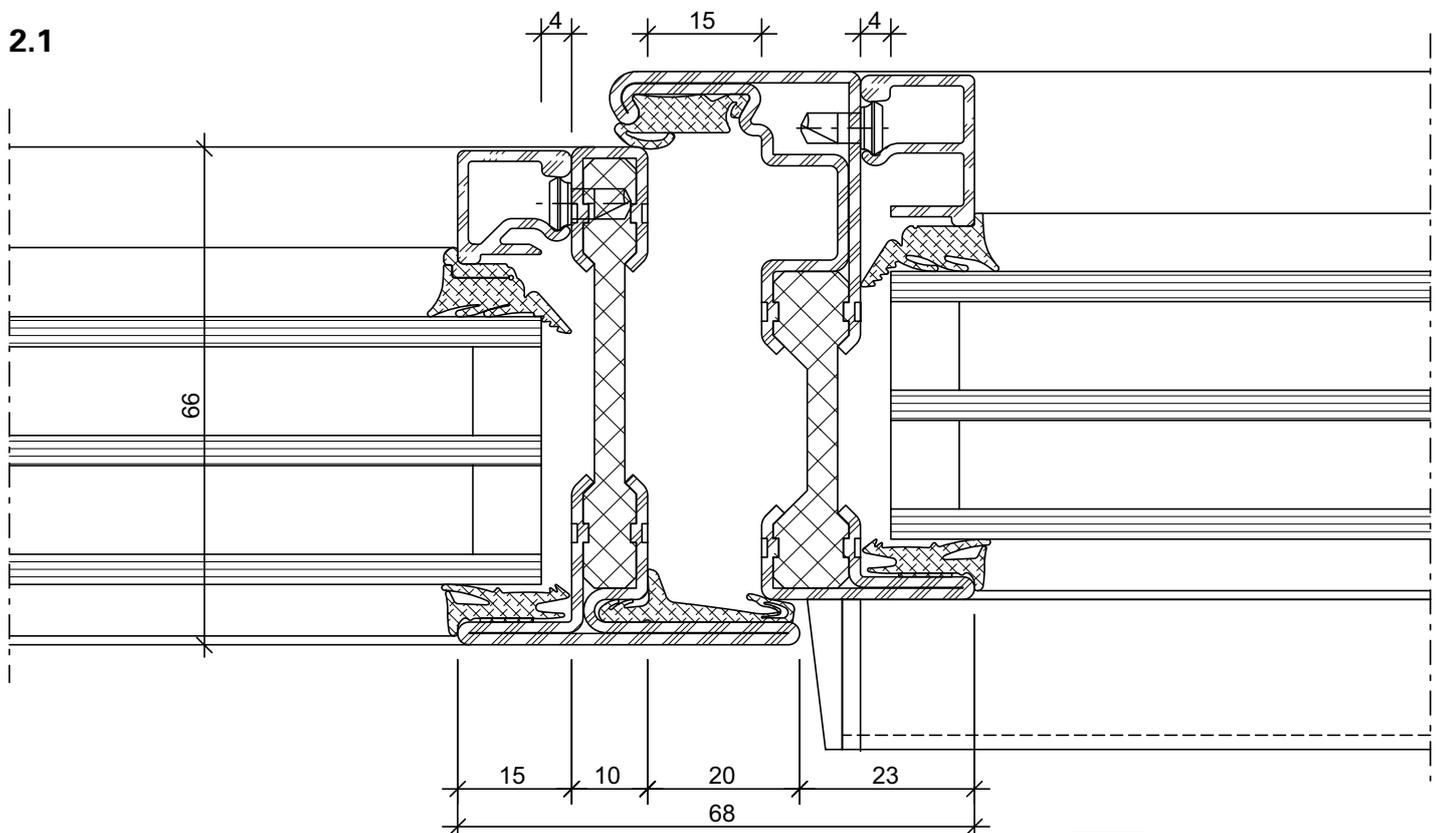

DXF

DWG

13-0108-C-004

Schnittpunkte nach innen öffnend im Massstab 1:1
Coupe de détails ouvrant vers l'intérieur à l'échelle 1:1
Section details opening inwards on scale 1:1

Janisol Arte 66
Janisol Arte 66
Janisol Arte 66

2.2

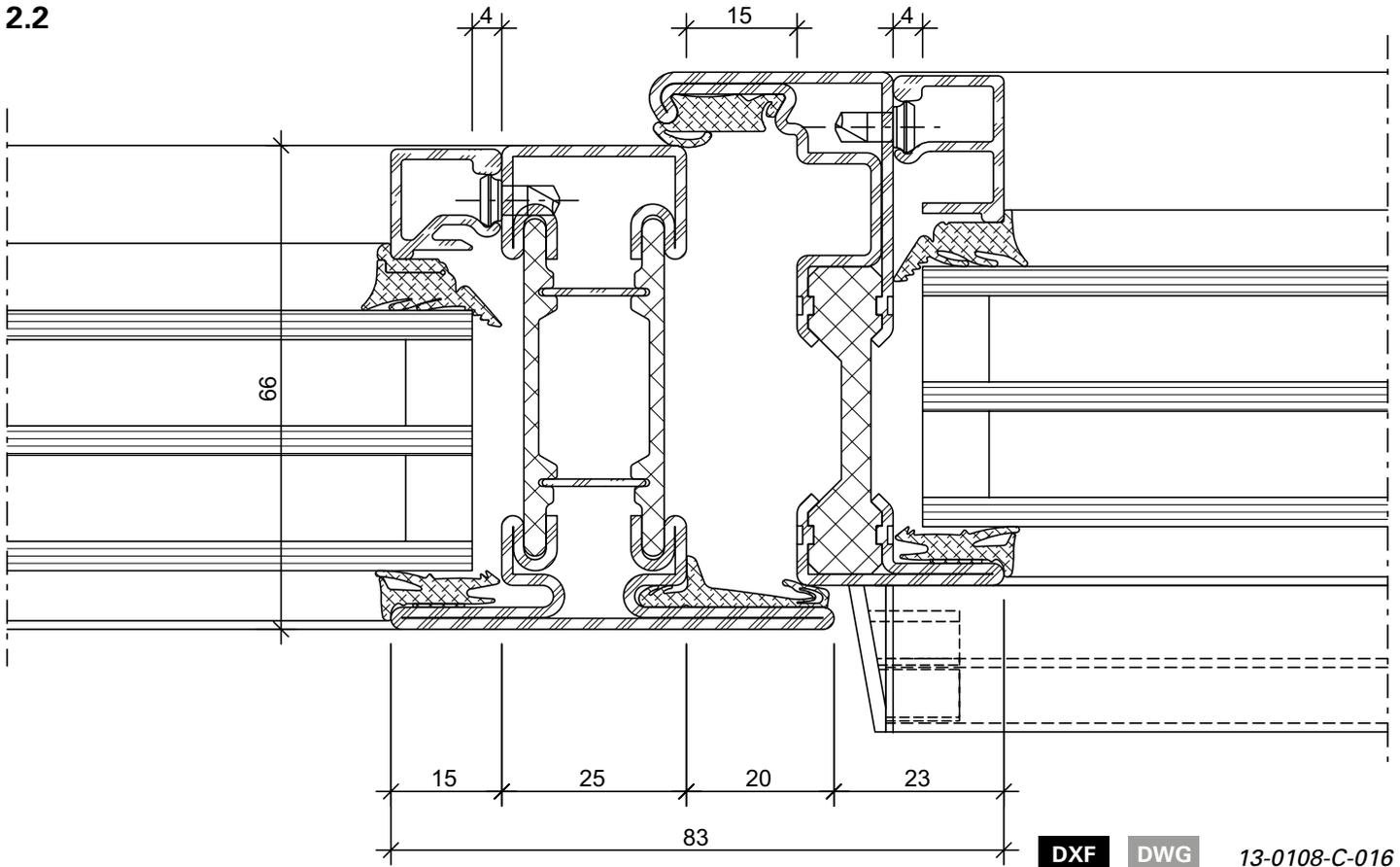

4.0

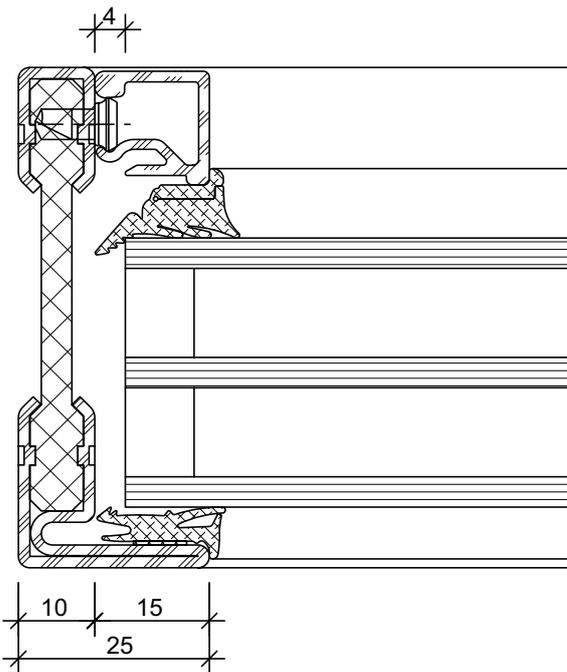

5.0

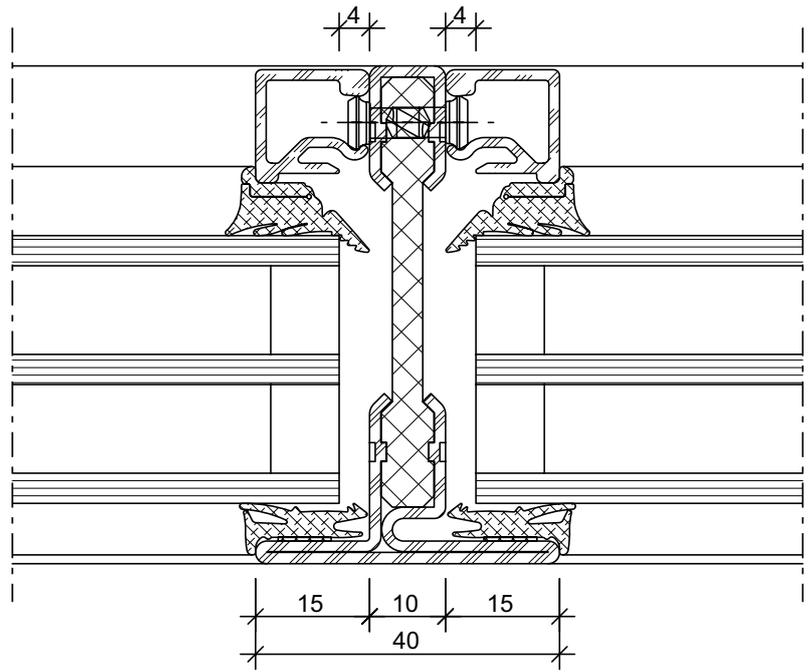

4.1

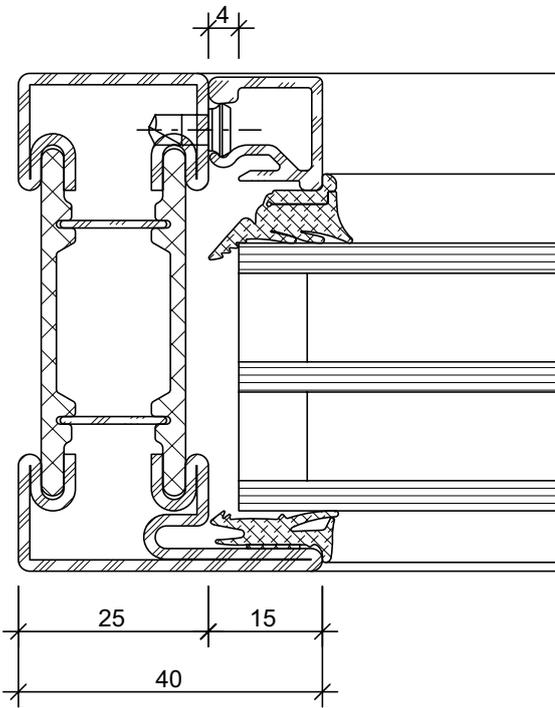

DXF

DWG

13-0108-C-017

5.1

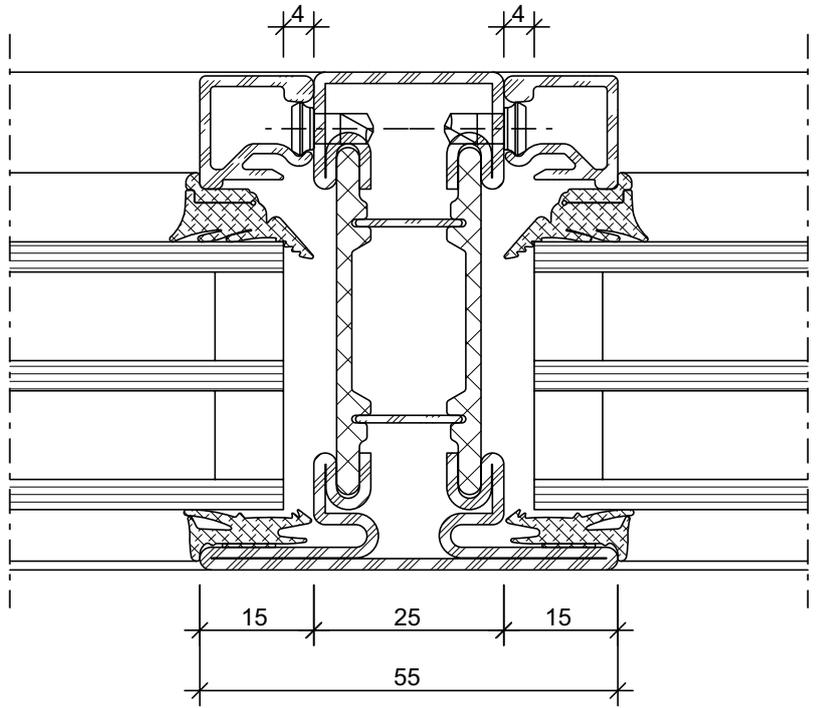

DXF

DWG

13-0108-C-018

5.2

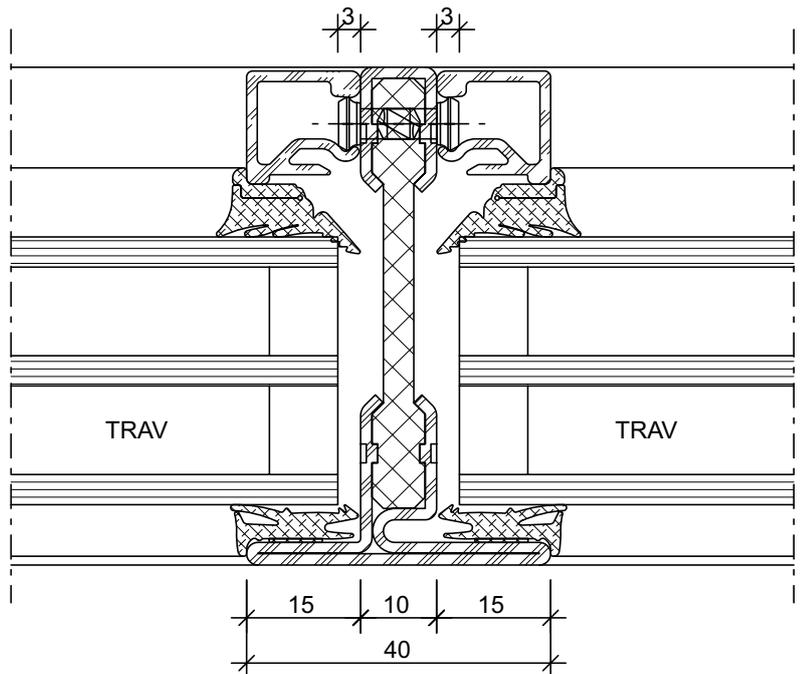

DXF

DWG

13-0108-C-014

6.0

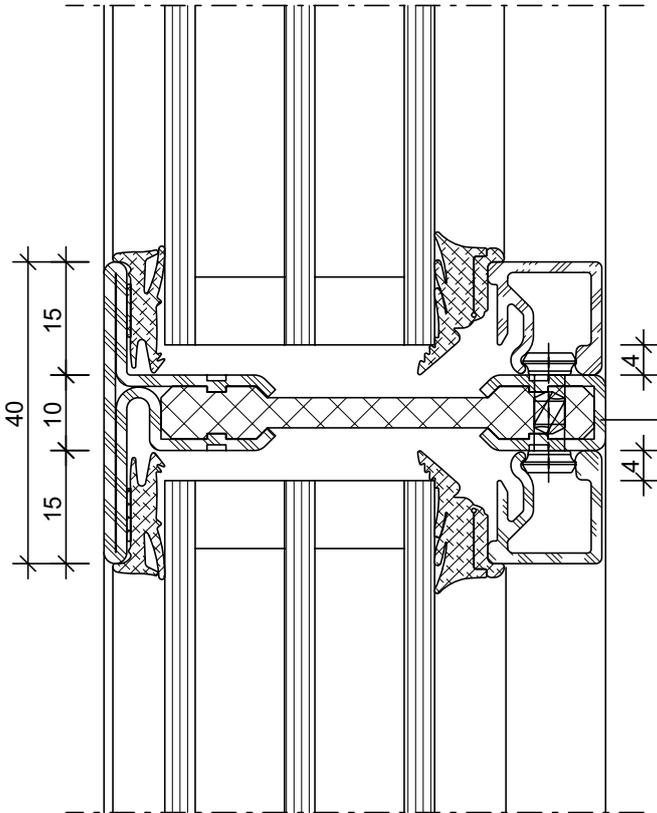

13-0108-C-009

DWG

DXF

4.1

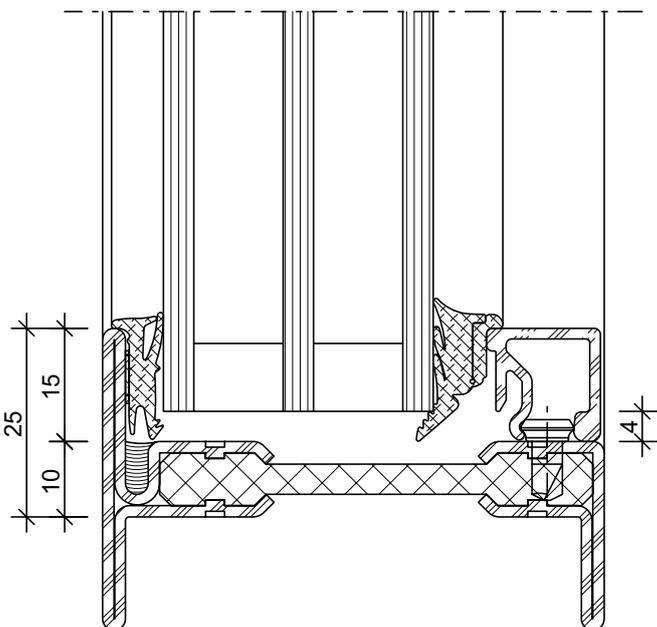

13-0108-C-008

DWG

DXF

Schnittpunkte nach innen öffnend im Massstab 1:1
Coupe de détails ouvrant vers l'intérieur à l'échelle 1:1
Section details opening inwards on scale 1:1

Janisol Arte 66
Janisol Arte 66
Janisol Arte 66

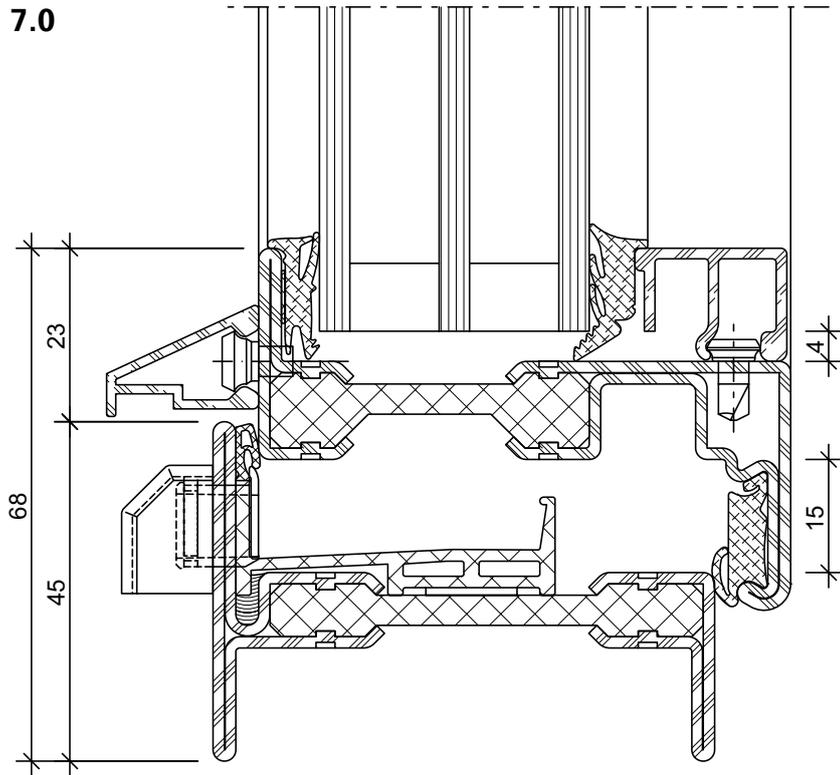

13-0108-C-010

DWG

DXF

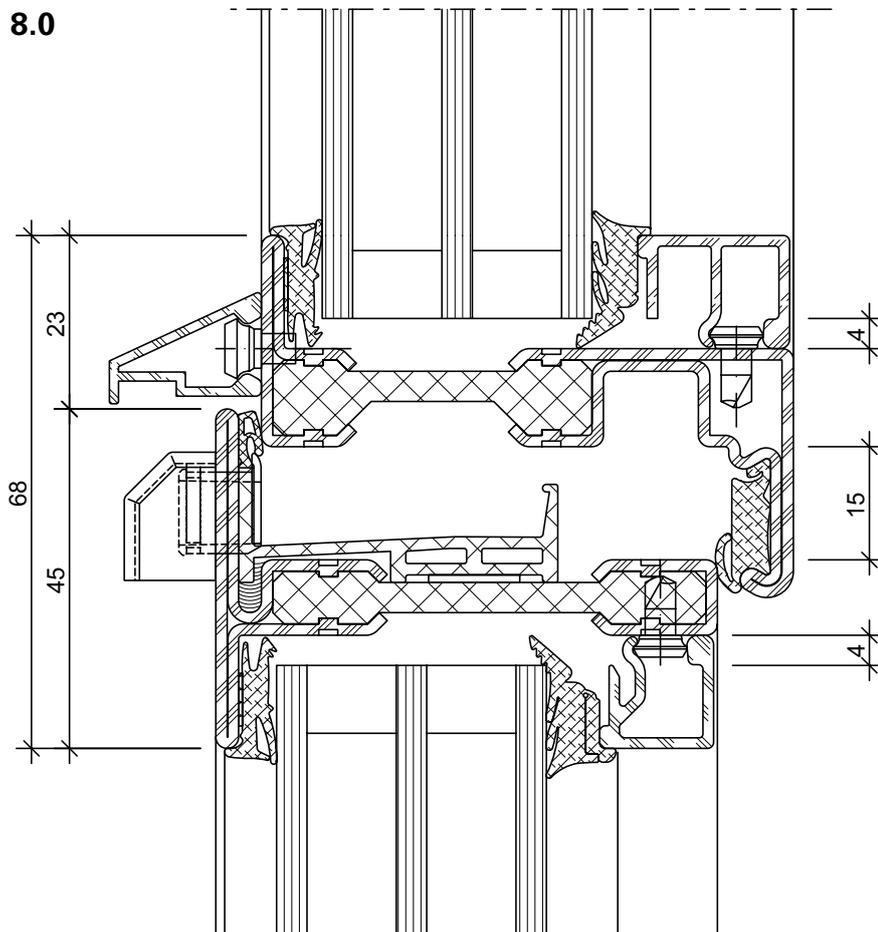

13-0108-C-013

DWG

DXF

Schnittpunkte nach innen öffnend im Masstab 1:1
Coupe de détails ouvrant vers l'intérieur à l'échelle 1:1
Section details opening inwards on scale 1:1

Janisol Arte 66
Janisol Arte 66
Janisol Arte 66

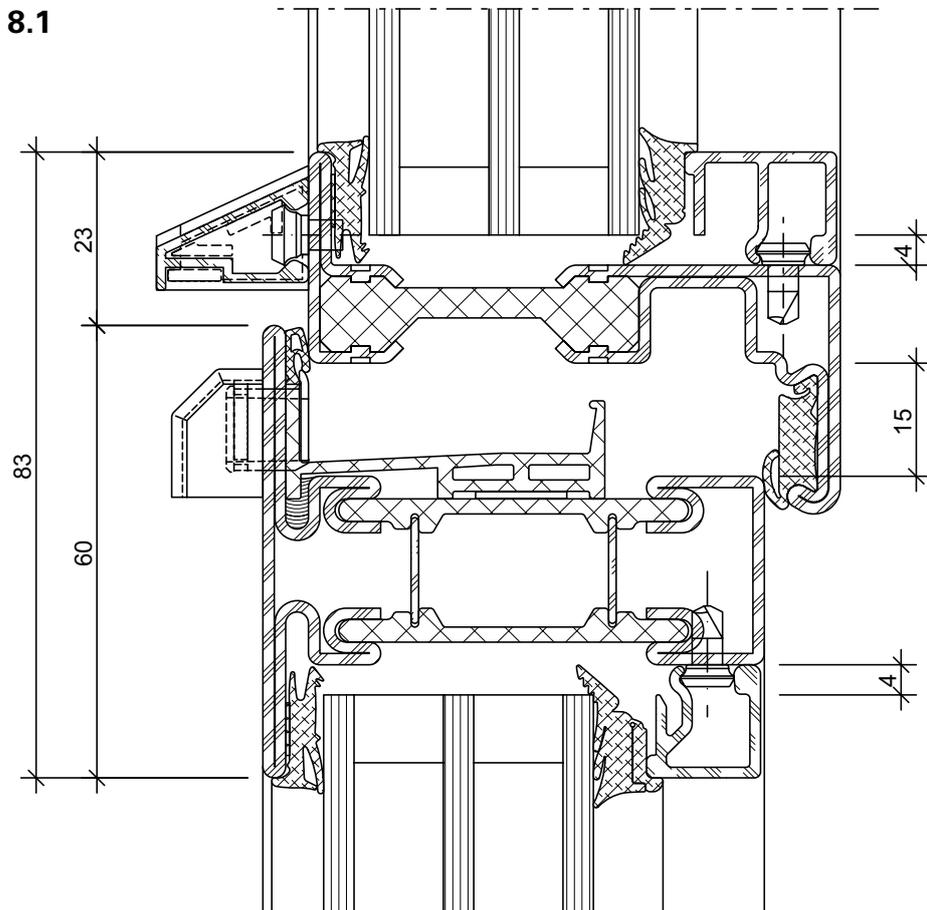
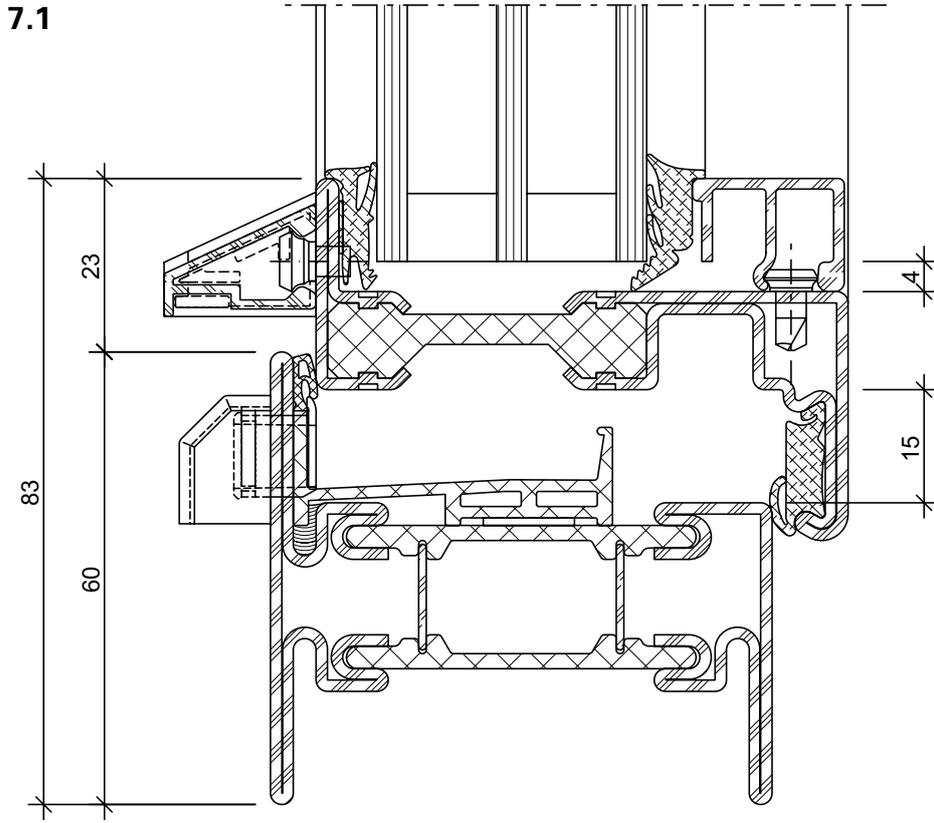

13-0108-C-019

DWG

DXF

13-0108-C-021

DWG

DXF

Schnittpunkte nach innen öffnend im Massstab 1:1
Coupe de détails ouvrant vers l'intérieur à l'échelle 1:1
Section details opening inwards on scale 1:1

Janisol Arte 66
Janisol Arte 66
Janisol Arte 66

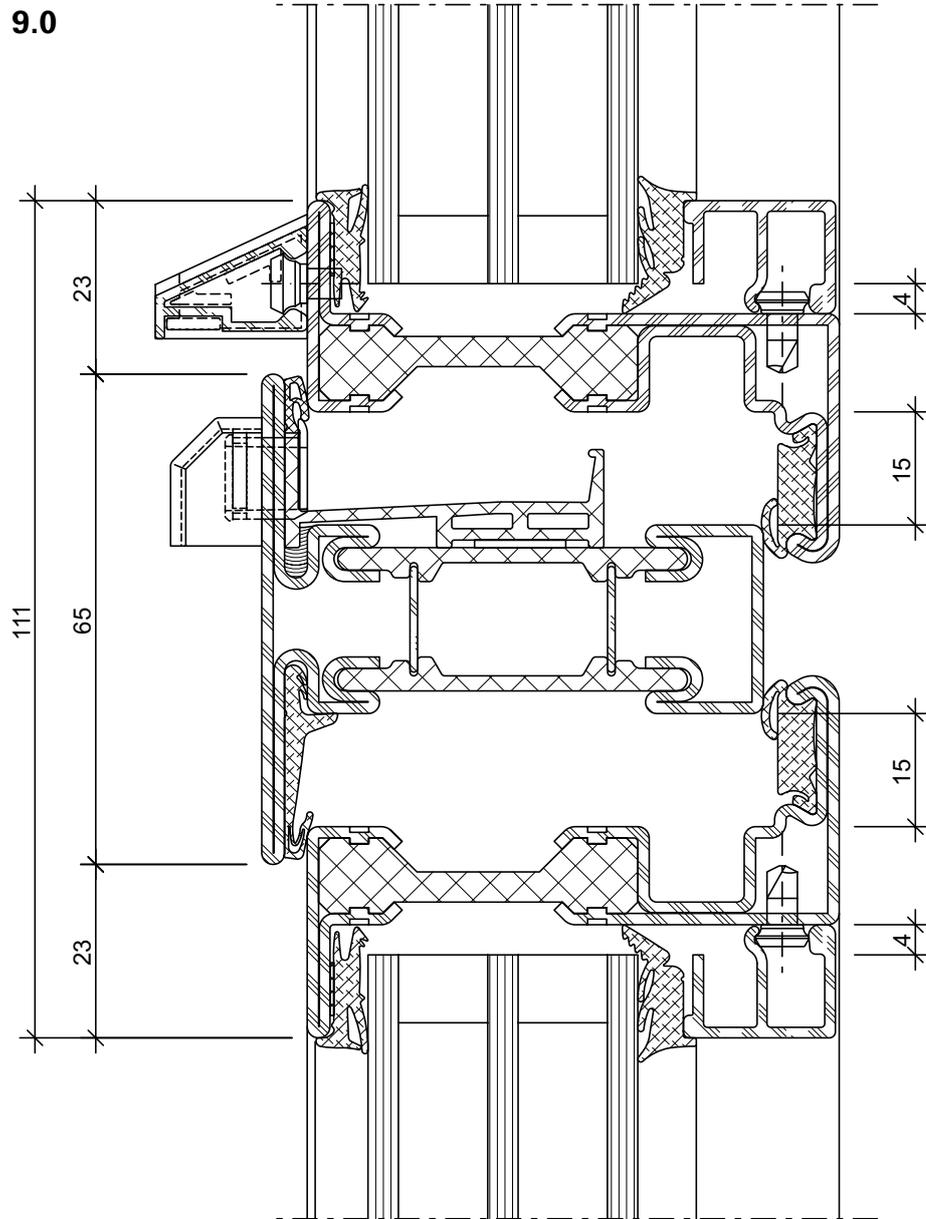

13-0108-C-020

DWG

DXF

Aluminium

Stahl / Acier / Steel

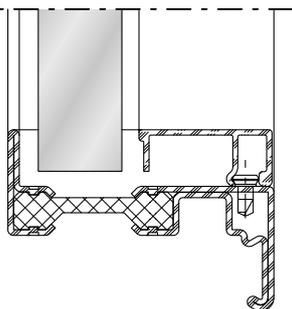
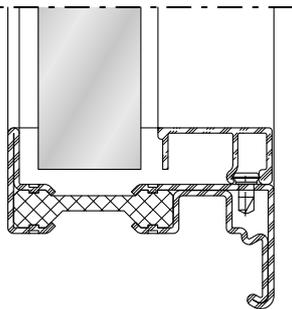
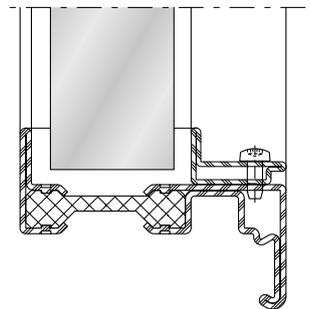
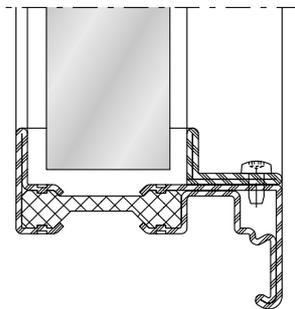
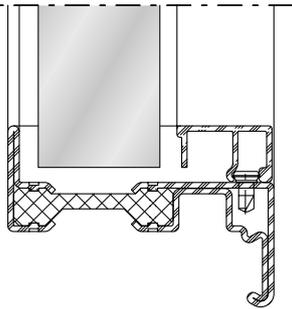
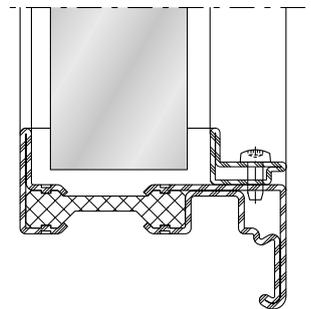
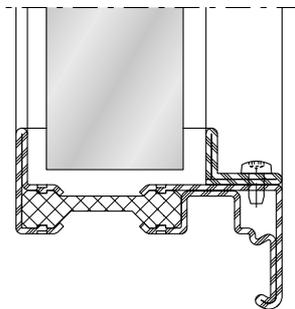
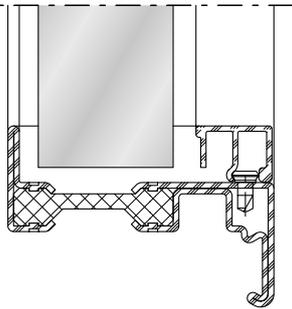
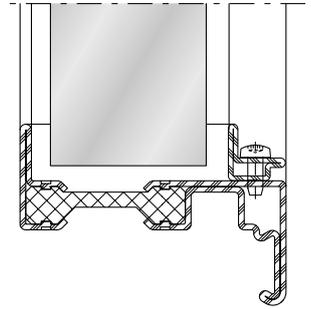
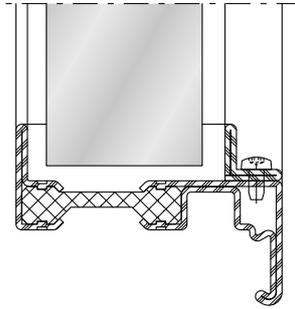
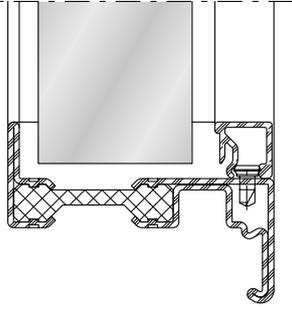

Platzbedarf
Verdeckt liegender Fensterbeschlag

Espace nécessaire
Ferrure de fenêtre non apparente

Space required
Concealed window fitting

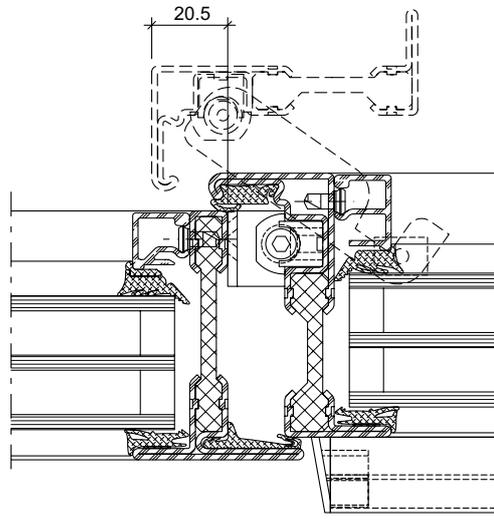
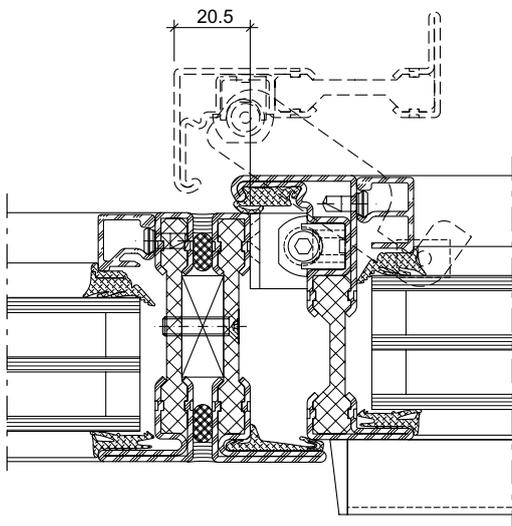
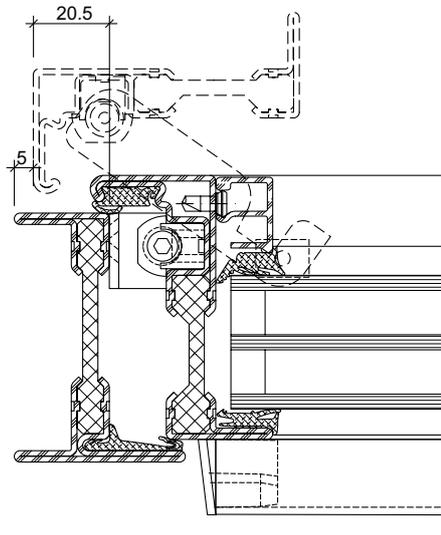
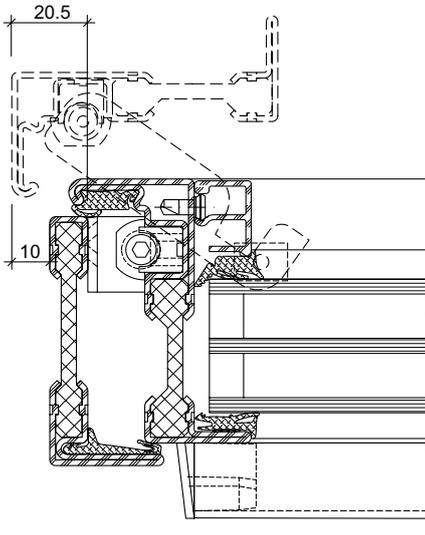

Platzbedarf
Verdeckt liegender Fensterbeschlag

Espace nécessaire
Ferrure de fenêtre non apparente

Space required
Concealed window fitting

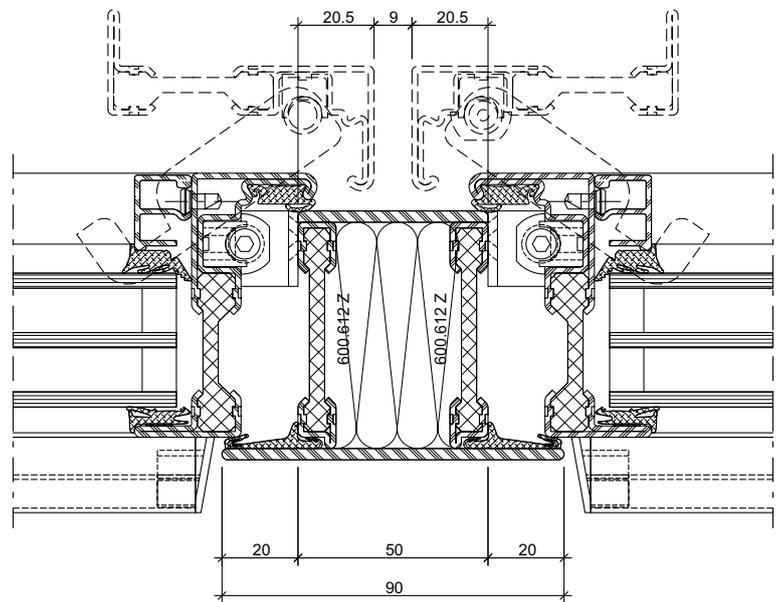
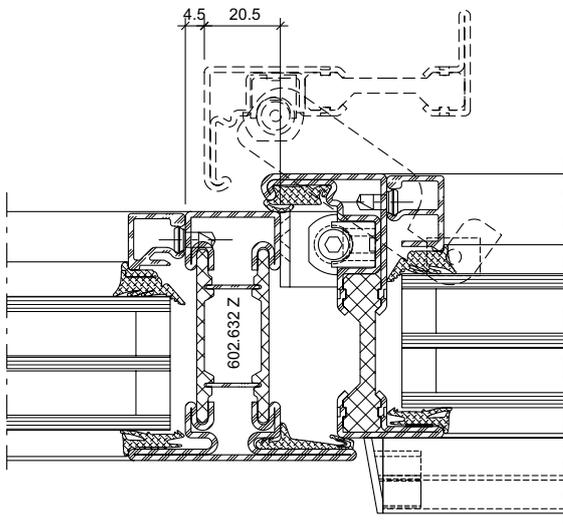
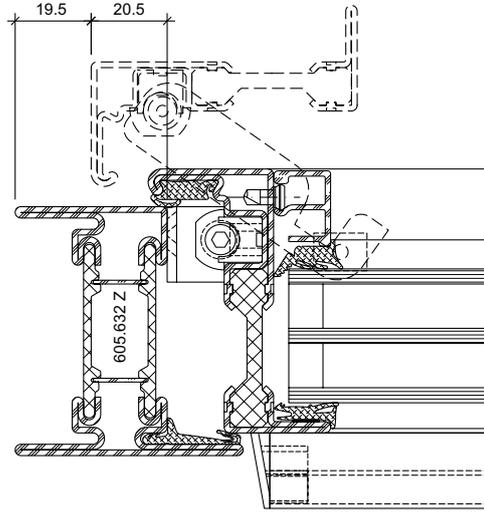
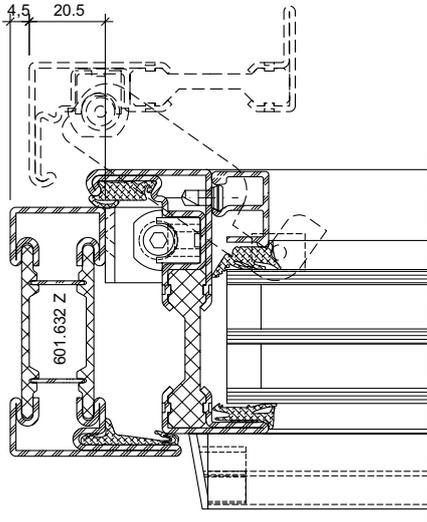

Anschlüsse am Bau im Masstab 1:2
Raccords au mur à l'échelle 1:2
Attachment to structure on scale 1:2

Janisol Arte 66
Janisol Arte 66
Janisol Arte 66

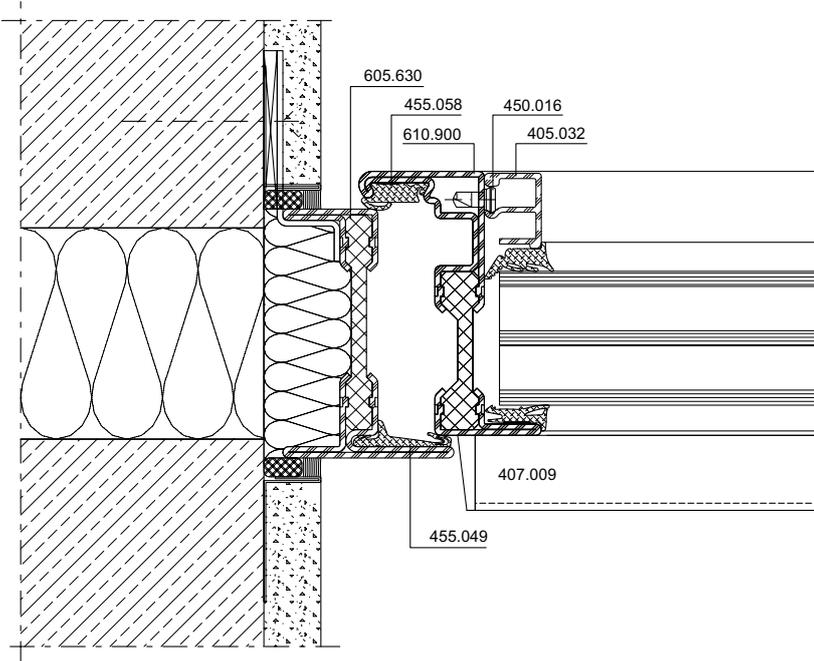

DXF **DWG** 13-0108-A-001

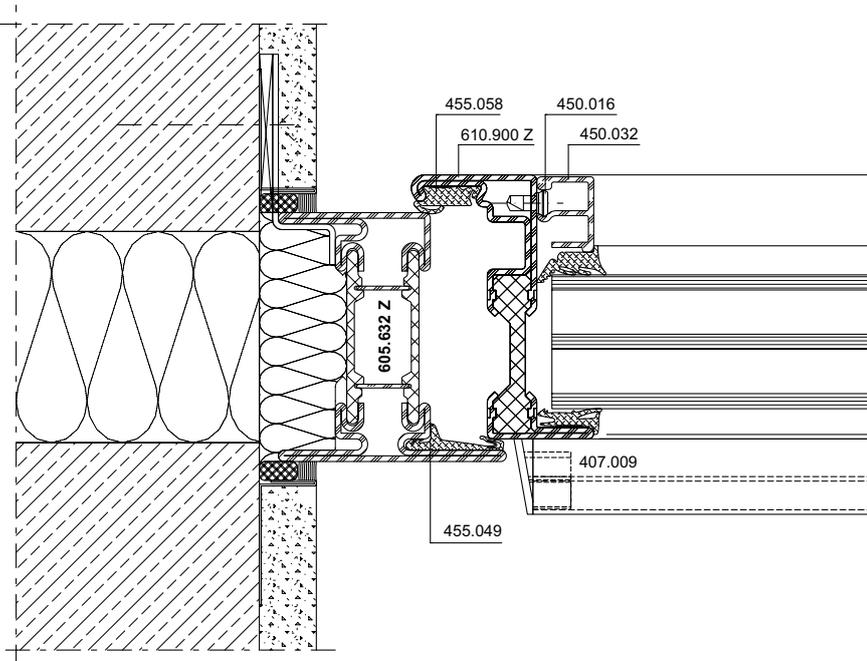

DXF **DWG** 13-0108-A-005

Anschlüsse am Bau im Massstab 1:2
Raccords au mur à l'échelle 1:2
Attachment to structure on scale 1:2

Janisol Arte 66
Janisol Arte 66
Janisol Arte 66

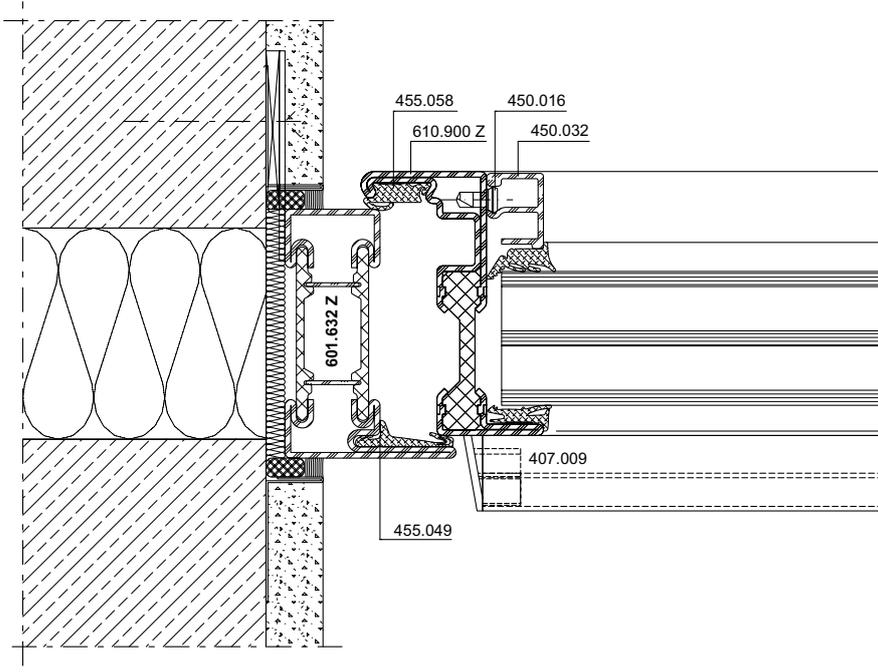

DXF **DWG** 13-0108-A-006

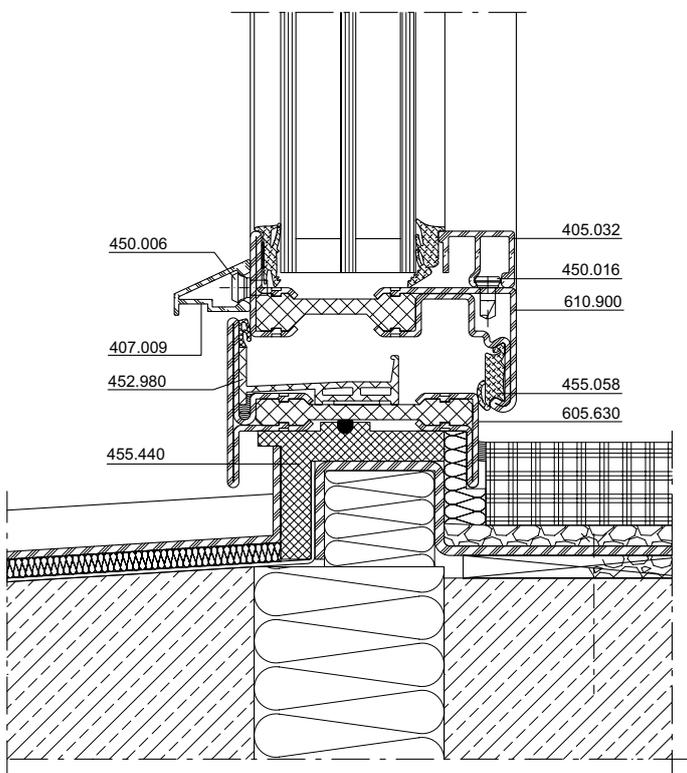

DXF **DWG** 13-0108-A-002

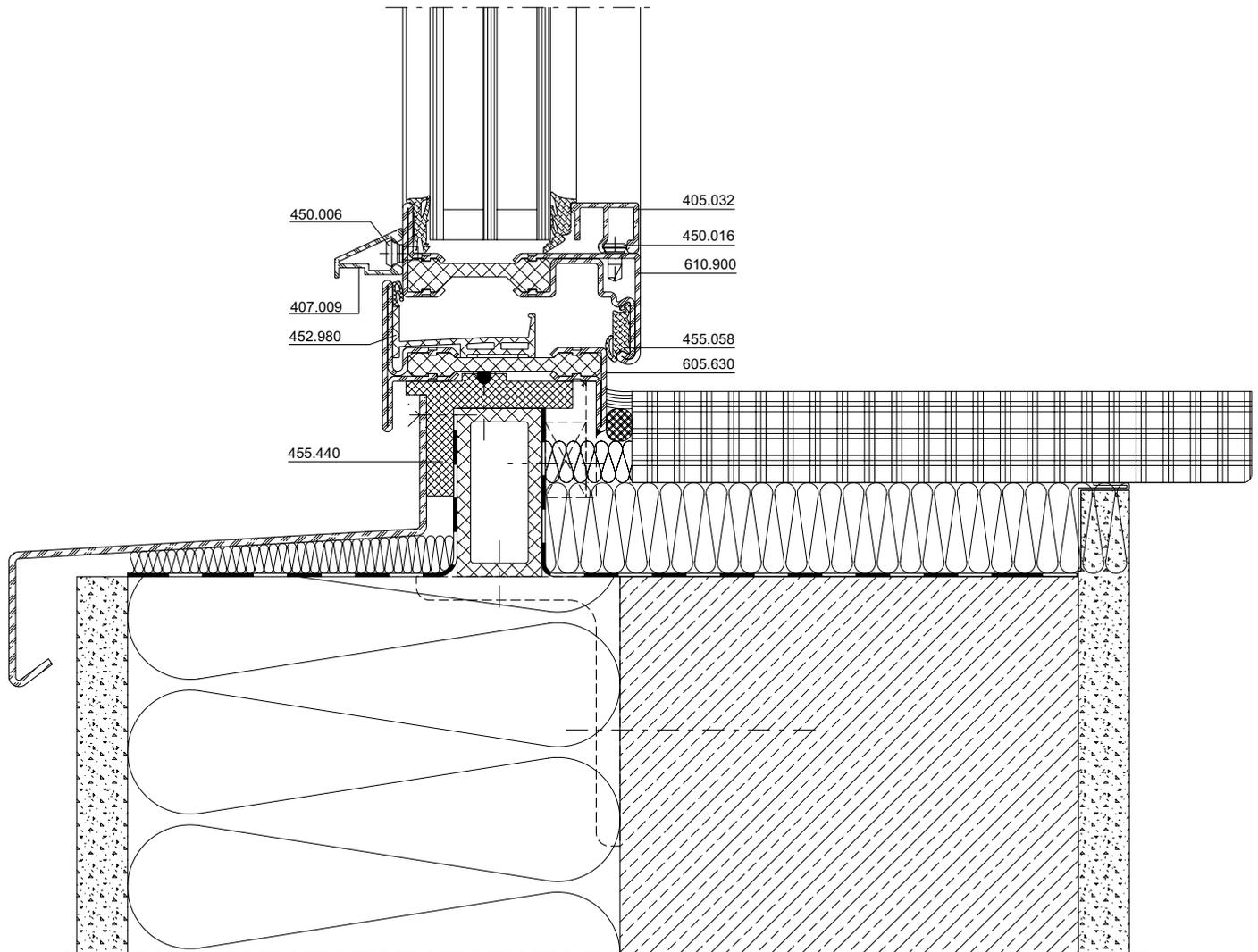

DXF

DWG

13-0108-A-003

Anschlüsse am Bau im Massstab 1:2
Raccords au mur à l'échelle 1:2
Attachment to structure on scale 1:2

Janisol Arte 66
Janisol Arte 66
Janisol Arte 66

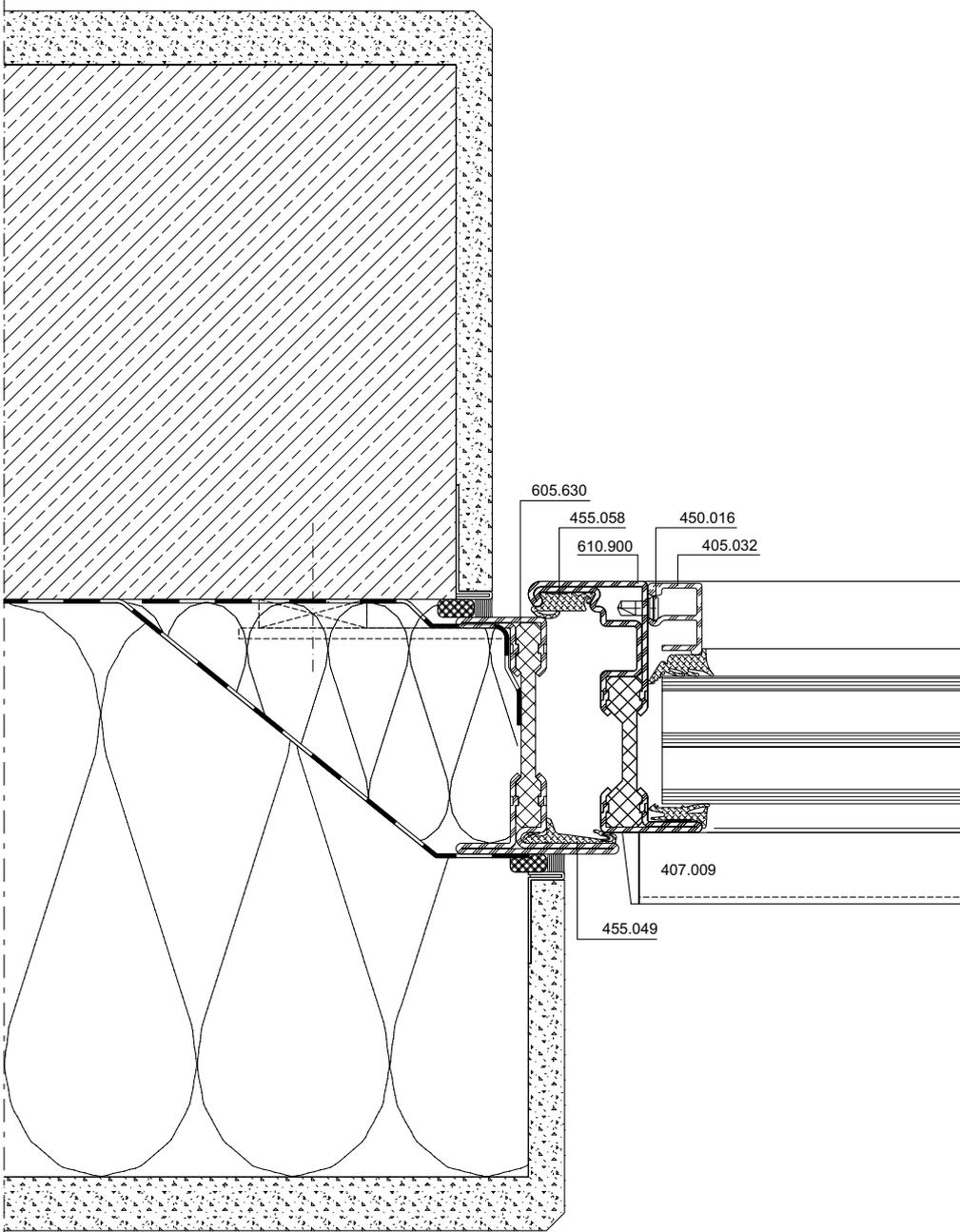

DXF

DWG

13-0108-A-004

Anschlüsse am Bau im Masstab 1:2
Raccords au mur à l'échelle 1:2
Attachment to structure on scale 1:2

Janisol Arte 66
Janisol Arte 66
Janisol Arte 66

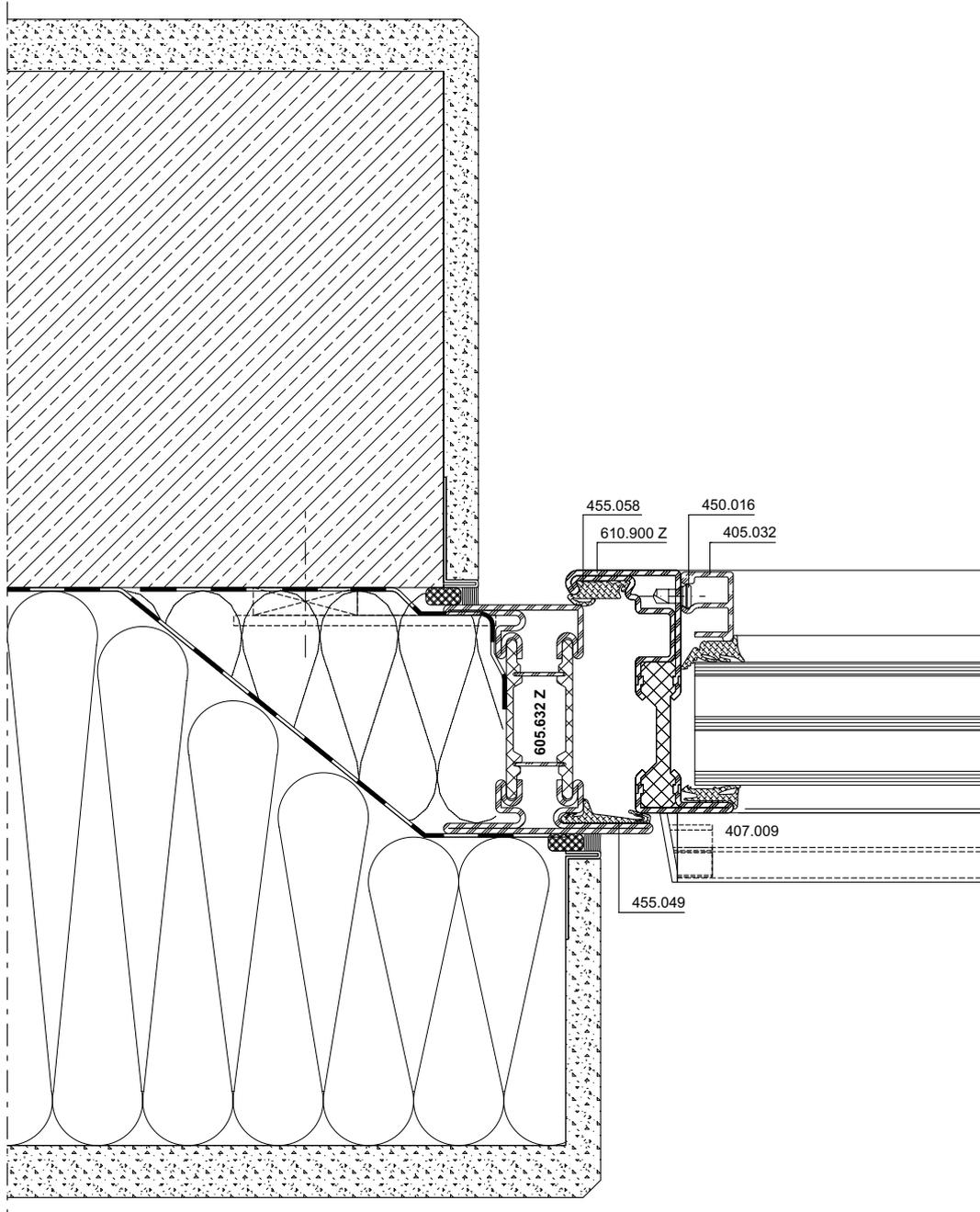

DXF

DWG

13-0108-A-007

Leistungswerte

Caractéristiques de performances

Performance values

Schlagregendichtheit
 Luftdurchlässigkeit
 Widerstand bei Windlast

Étanchéité à la pluie battante
 Perméabilité à l'air
 Résistance à la pression du vent

Watertightness
 Air permeability
 Resistance to wind load

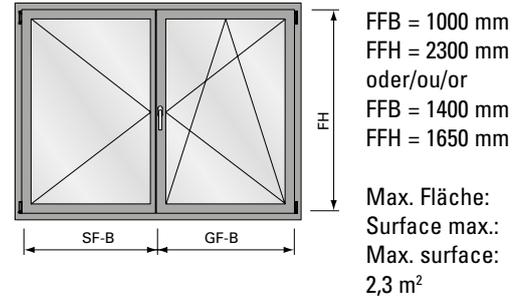
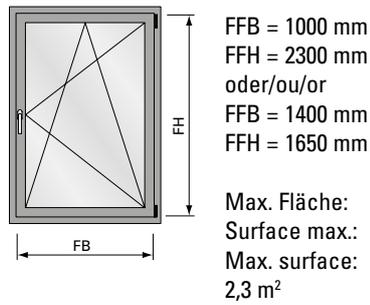

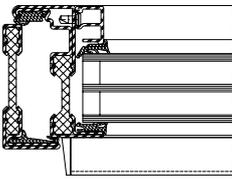
	 EN 12208	 EN 12207	 EN 12210	 EN 12208	 EN 12207	 EN 12210
bis / jusqu'à / up to FFH 1650 mm 	Klasse 9A Classe 9A Class 9A	Klasse 4 Classe 4 Class 4	Klasse C5/B5 Classe C5/B5 Class C5/B5	Klasse 7A Classe 7A Class 7A	Klasse 4 Classe 4 Class 4	Klasse C4/B4 Classe C4/B4 Class C4/B4
Größenänderungen Variations dimensionnelles Size changes	-100%	-100%	-100%	-100%	-100%	-100%

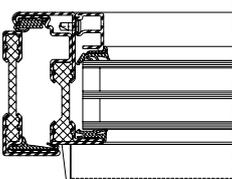
	 EN 12208	 EN 12207	 EN 12210	 EN 12208	 EN 12207	 EN 12210
bis / jusqu'à / up to FFH 2300 mm bis / jusqu'à / up to FFB 1000 mm 	Klasse 8A Classe 8A Class 8A	Klasse 4 Classe 4 Class 4	Klasse C5/B5 Classe C5/B5 Class C5/B5	Klasse 7A Classe 7A Class 7A	Klasse 4 Classe 4 Class 4	Klasse C4/B4 Classe C4/B4 Class C4/B4
Größenänderungen Variations dimensionnelles Size changes	-100%	-100%	-100%	-100%	-100%	-100%

Schlagregendichtheit
Luftdurchlässigkeit
Widerstand bei Windlast

Étanchéité à la pluie battante
Perméabilité à l'air
Résistance à la pression du vent

Watertightness
Air permeability
Resistance to wind load

Festverglasung

Vitrage fixe

Fixed glazing

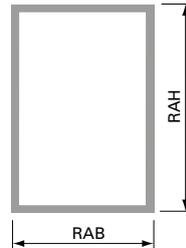

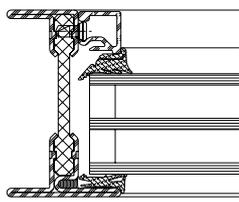
	 EN 12208	 EN 12207	 EN 12210
RABxRAH 1230x1480 mm 	Klasse 9A Classe 9A Class 9A	Klasse 4 Classe 4 Class 4	Klasse C5/B5 Classe C5/B5 Class C5/B5

**Schlagregendichtheit
 Luftdurchlässigkeit
 Widerstand bei Windlast**

**Étanchéité à la pluie battante
 Perméabilité à l'air
 Résistance à la pression du vent**

**Watertightness
 Air permeability
 Resistance to wind load**

Kippfenster

Fenêtre à sofflet

Bottom-hung window

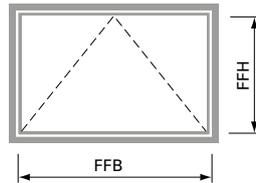

FFB = 2300 mm
 FFH = 2300 mm

in Abhängigkeit des Verriegelungsabstandes
 en fonction de l'écart de verrouillage
 depending on the distance between locking points

Max. Fläche:
 Surface max.:
 Max. surface:
 2,3 m²

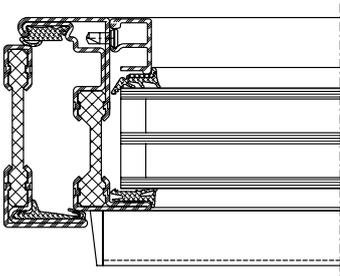
	 EN 12208	 EN 12207	 EN 12210
Beschlag/Ferrure/Fitting 	Klasse 8A Classe 8A Class 8A	Klasse 4 Classe 4 Class 4	Klasse C5/B5 Classe C5/B5 Class C5/B5
Schnäpper 557.099 Loqueteau 557.099 Spring catch 557.099	Klasse 8A Classe 8A Class 8A	Klasse 4 Classe 4 Class 4	Klasse C3/B3 Classe C3/B3 Class C3/B3
Oberlichtöffner 550.651 Ferrure d'imposte 550.651 Top light opener 550.651	Klasse 8A Classe 8A Class 8A	Klasse 3 Classe 3 Class 3	Klasse C3/B3 Classe C3/B3 Class C3/B3
Kettenantrieb 550.697 Entraînement à chaîne 550.697 Chain drive 550.697	Klasse 8A Classe 8A Class 8A	Klasse 4 Classe 4 Class 4	Klasse C3/B3 Classe C3/B3 Class C3/B3

U_f-Werte
(nach EN ISO 10077-2:2018-01)

Auf den folgenden Seiten finden Sie die U_f-Werte für die verschiedenen Anwendungen von Janisol Arte 2.0.

Sie basieren auf folgenden Grundlagen:

- Profile bandverzinkter Stahl, unbeschichtet
- Aluminium-Glasleisten
- Nassverglasung

Valeurs U_f
(selon EN ISO 10077-2:2018-01)

Vous trouverez les valeurs U_f pour les différentes applications Janisol Arte 2.0 dans les pages qui suivent.

Elles se basent sur les principes suivants:

- Profilés en bande d'acier zingué, sans revêtement
- Parcloles en aluminium
- Vitrage à mastic

U_f values
(according to EN ISO 10077-2:2018-01)

On the following pages you will find the U_f values for the various applications for Janisol Arte 2.0.

They are based on the following:

- Strip galvanised steel profiles, uncoated
- Aluminium glazing beads
- Glazing with sealing

Janisol Arte Stahl
Zweifach-Isolierglas

Janisol Arte acier
Double verre isolant

Janisol Arte steel
Double insulating glazing

Janisol Arte Stahl
Dreifach-Isolierglas

Janisol Arte acier
Triple verre isolant

Janisol Arte steel
Triple insulating glazing

Janisol Arte Stahl
optimiert
Zweifach-Isolierglas

Janisol Arte acier
optimisé
Double verre isolant

Janisol Arte steel
optimised
Double insulating glazing

Janisol Arte Stahl
optimiert
Dreifach-Isolierglas

Janisol Arte acier
optimisé
Triple verre isolant

Janisol Arte steel
optimised
Triple insulating glazing

Janisol Arte Stahl
Zweifach-Isolierglas

Festverglasungen und
 Fenster nach innen öffnend

Janisol Arte acier
Double verre isolant

Vitrages fixes et fenêtres
 ouvrant vers l'intérieur

Janisol Arte steel
Double insulating glazing

Fixed lights and
 windows inward opening

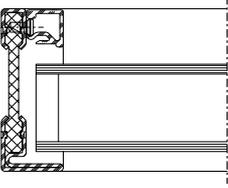
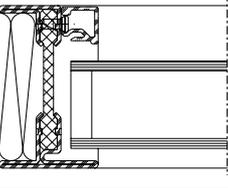
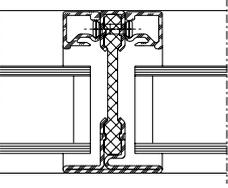
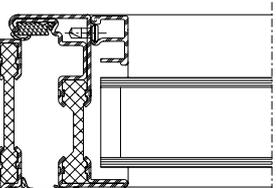
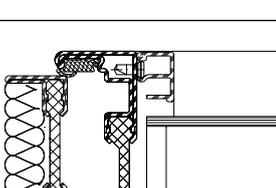
	Füllelementstärken Éléments de remplissages Infill elements	
	≥ 24 mm	≥ 28 mm
	2,9 W/m ² K	2,6 W/m ² K
	2,2 W/m ² K	2,0 W/m ² K
	2,8 W/m ² K	2,5 W/m ² K
	3,3 W/m ² K	3,2 W/m ² K
	2,8 W/m ² K	2,8 W/m ² K

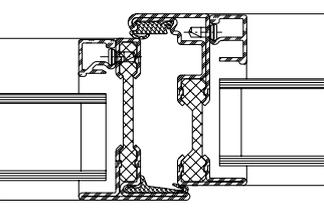
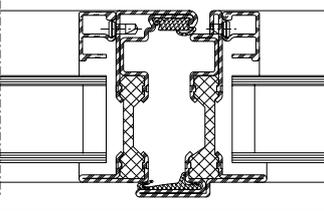
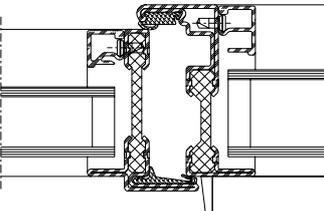
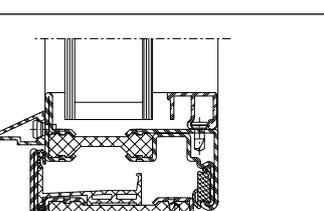
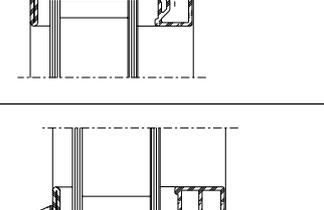
	Füllelementstärken Éléments de remplissages Infill elements	
	≥ 24 mm	≥ 28 mm
	3,3 W/m ² K	3,2 W/m ² K
	3,3 W/m ² K	3,2 W/m ² K
	3,2 W/m ² K	3,1 W/m ² K
	3,2 W/m ² K	3,1 W/m ² K
	2,8 W/m ² K	2,8 W/m ² K

Janisol Arte Stahl
Zweifach-Isolierglas

Festverglasungen und
 Fenster nach innen öffnend

Janisol Arte acier
Double verre isolant

Vitrages fixes et fenêtres
 ouvrant vers l'intérieur

Janisol Arte steel
Double insulating glazing

Fixed lights and
 windows inward opening

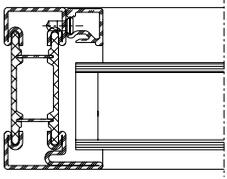
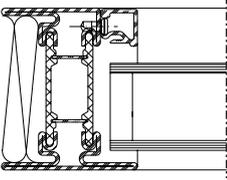
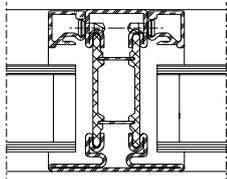
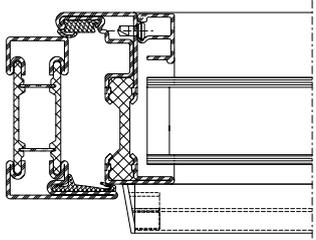
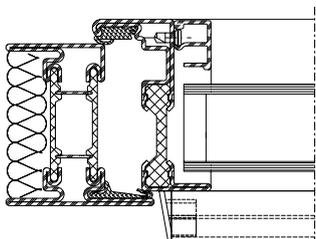
	Füllelementstärken Eléments de remplissages Infill elements	
	≥ 24 mm	≥ 28 mm
	2,1 W/m²K	2,0 W/m²K
	1,7 W/m²K	1,6 W/m²K
	2,2 W/m²K	2,0 W/m²K
	2,8 W/m²K	2,8 W/m²K
	2,5 W/m²K	2,5 W/m²K

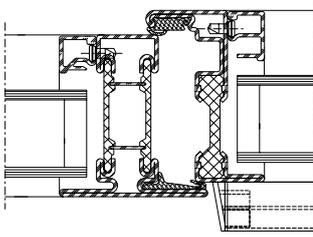
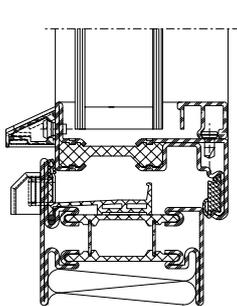
	Füllelementstärken Eléments de remplissages Infill elements	
	≥ 24 mm	≥ 28 mm
	2,8 W/m²K	2,7 W/m²K
	2,4 W/m²K	2,4 W/m²K

**Janisol Arte Stahl
 Dreifach-Isolierglas**

Festverglasungen und
 Fenster nach innen öffnend

**Janisol Arte acier
 Triple verre isolant**

Vitrages fixes et fenêtres
 ouvrant vers l'intérieur

**Janisol Arte steel
 Triple insulating glazing**

Fixed lights and
 windows inward opening

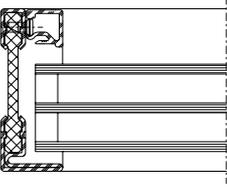
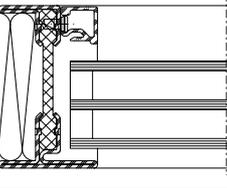
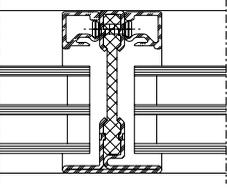
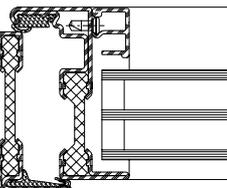
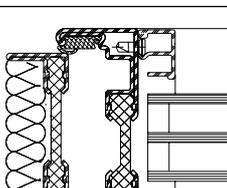
	Füllelementstärken Éléments de remplissages Infill elements	
	≥ 36 mm	≥ 46 mm
	2,4 W/m ² K	2,3 W/m ² K
	1,9 W/m ² K	1,8 W/m ² K
	2,3 W/m ² K	2,2 W/m ² K
	3,2 W/m ² K	3,1 W/m ² K
	2,8 W/m ² K	2,8 W/m ² K

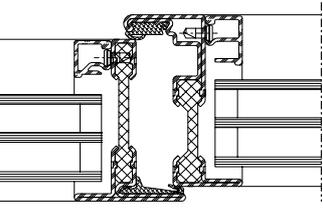
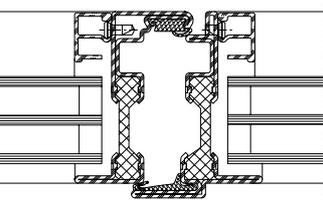
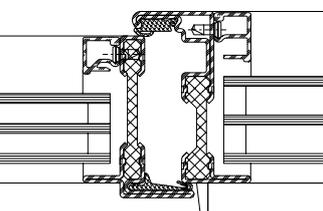
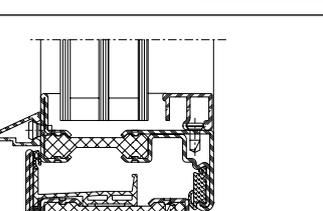
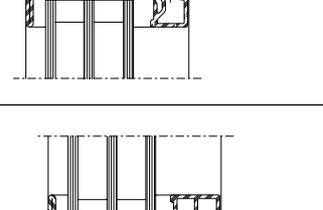
	Füllelementstärken Éléments de remplissages Infill elements	
	≥ 36 mm	≥ 46 mm
	3,1 W/m ² K	3,0 W/m ² K
	3,1 W/m ² K	3,1 W/m ² K
	3,0 W/m ² K	3,0 W/m ² K
	3,0 W/m ² K	2,9 W/m ² K
	2,7 W/m ² K	2,7 W/m ² K

Janisol Arte Stahl
Dreifach-Isolierglas

Festverglasungen und
 Fenster nach innen öffnend

Janisol Arte acier
Triple verre isolant

Vitrages fixes et fenêtres
 ouvrant vers l'intérieur

Janisol Arte steel
Triple insulating glazing

Fixed lights and
 windows inward opening

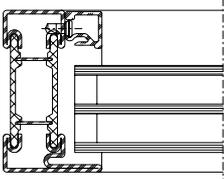
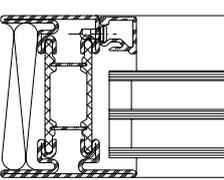
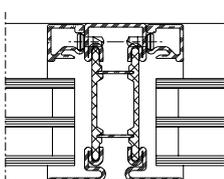
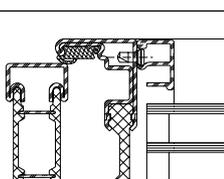
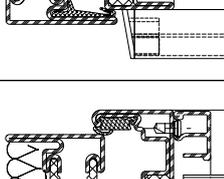
	Füllelementstärken Eléments de remplissages Infill elements	
	≥ 36 mm	≥ 46 mm
	1,9 W/m²K	1,8 W/m²K
	1,6 W/m²K	1,5 W/m²K
	1,8 W/m²K	1,8 W/m²K
	2,7 W/m²K	2,7 W/m²K
	2,4 W/m²K	2,4 W/m²K

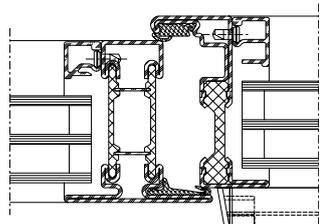
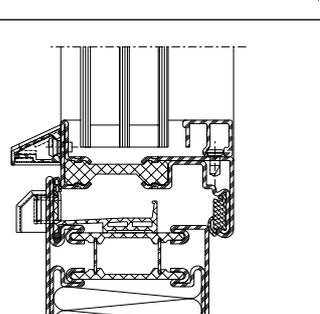
	Füllelementstärken Eléments de remplissages Infill elements	
	≥ 36 mm	≥ 46 mm
	2,6 W/m²K	2,6 W/m²K
	2,4 W/m²K	2,4 W/m²K

**Janisol Arte Stahl
 optimiert
 Zweifach-Isolierglas**

Festverglasungen und
 Fenster nach innen öffnend

**Janisol Arte acier
 optimisé
 Double verre isolant**

Vitrages fixes et fenêtres
 ouvrant vers l'intérieur

**Janisol Arte steel
 optimised
 Double insulating glazing**

Fixed lights and
 windows inward opening

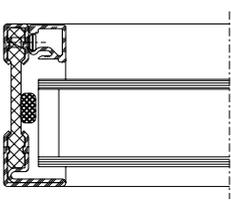
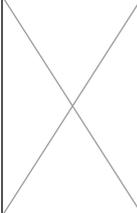
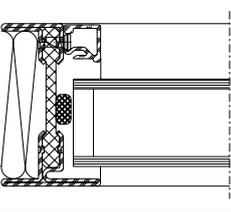
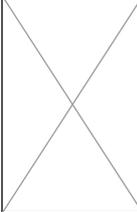
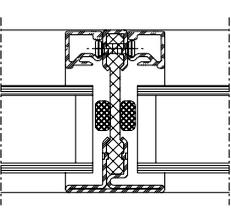
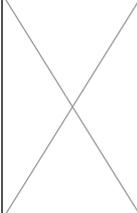
	Füllelementstärken Éléments de remplissages Infill elements ≥ 28 mm	
	Dämmprofil Glasfalz Profilé isolant Feuillure de verre Insulation profile Glazing rebate	Dämmprofil Glas- und Rahmenfalz Profilé isolant Feuillure de verre et de cadre Insulation profile Glazing and frame rebate
	2,4 W/m²K	
	1,8 W/m²K	
	2,1 W/m²K	

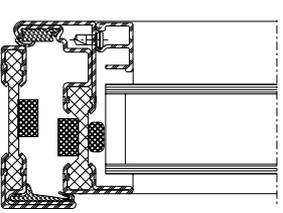
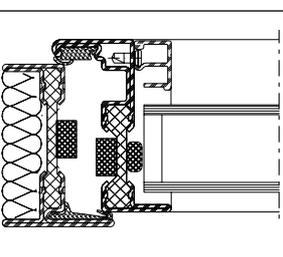
	Füllelementstärken Éléments de remplissages Infill elements ≥ 28 mm	
	Dämmprofil Glasfalz Profilé isolant Feuillure de verre Insulation profile Glazing rebate	Dämmprofil Glas- und Rahmenfalz Profilé isolant Feuillure de verre et de cadre Insulation profile Glazing and frame rebate
	3,1 W/m²K	2,5 W/m²K
	2,7 W/m²K	2,2 W/m²K

**Janisol Arte Stahl
 optimiert
 Zweifach-Isolierglas**

Festverglasungen und
 Fenster nach innen öffnend

**Janisol Arte acier
 optimisé
 Double verre isolant**

Vitrages fixes et fenêtres
 ouvrant vers l'intérieur

**Janisol Arte steel
 optimised
 Double insulating glazing**

Fixed lights and
 windows inward opening

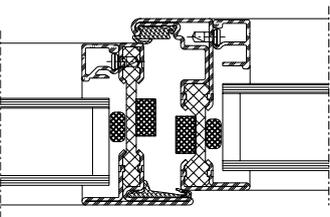
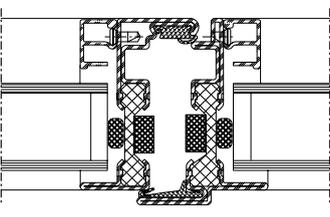
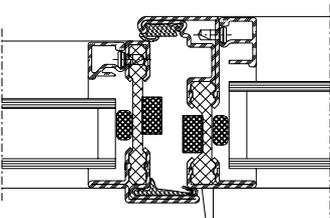
	Füllelementstärken Éléments de remplissages Infill elements ≥ 28 mm	
	Dämmprofil Glasfalz Profilé isolant Feuillure de verre Insulation profile Glazing rebate	Dämmprofil Glas- und Rahmenfalz Profilé isolant Feuillure de verre et de cadre Insulation profile Glazing and frame rebate
	3,0 W/m²K	2,4 W/m²K
	3,0 W/m²K	2,5 W/m²K
	2,9 W/m²K	2,4 W/m²K

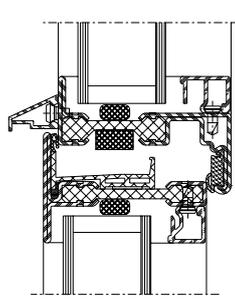
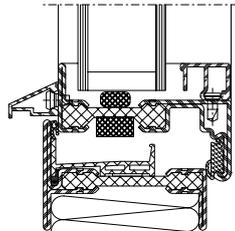
	Füllelementstärken Éléments de remplissages Infill elements ≥ 28 mm	
	Dämmprofil Glasfalz Profilé isolant Feuillure de verre Insulation profile Glazing rebate	Dämmprofil Glas- und Rahmenfalz Profilé isolant Feuillure de verre et de cadre Insulation profile Glazing and frame rebate
	2,9 W/m²K	2,6 W/m²K
	2,6 W/m²K	2,4 W/m²K

**Janisol Arte Stahl
 optimiert
 Zweifach-Isolierglas**

Festverglasungen und
 Fenster nach innen öffnend

**Janisol Arte acier
 optimisé
 Double verre isolant**

Vitrages fixes et fenêtres
 ouvrant vers l'intérieur

**Janisol Arte steel
 optimised
 Double insulating glazing**

Fixed lights and
 windows inward opening

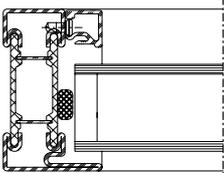
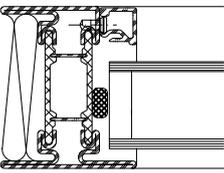
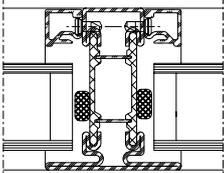
	Füllelementstärken Éléments de remplissages Infill elements ≥ 28 mm	
	Dämmprofil Glasfalz Profilé isolant Feuillure de verre Insulation profile Glazing rebate	Dämmprofil Glas- und Rahmenfalz Profilé isolant Feuillure de verre et de cadre Insulation profile Glazing and frame rebate
	1,8 W/m²K	
	1,5 W/m²K	
	1,7 W/m²K	

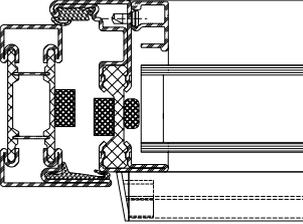
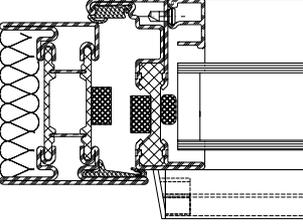
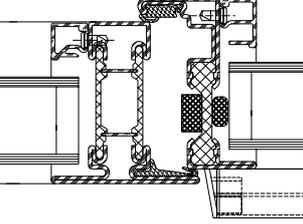
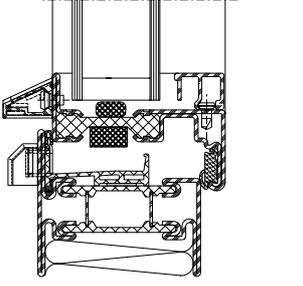
	Füllelementstärken Éléments de remplissages Infill elements ≥ 28 mm	
	Dämmprofil Glasfalz Profilé isolant Feuillure de verre Insulation profile Glazing rebate	Dämmprofil Glas- und Rahmenfalz Profilé isolant Feuillure de verre et de cadre Insulation profile Glazing and frame rebate
	2,7 W/m²K	2,2 W/m²K
	2,4 W/m²K	2,0 W/m²K
	2,6 W/m²K	2,1 W/m²K
	2,3 W/m²K	2,1 W/m²K

**Janisol Arte Stahl
 optimiert
 Dreifach-Isolierglas**

Festverglasungen und
 Fenster nach innen öffnend

**Janisol Arte acier
 optimisé
 Triple verre isolant**

Vitrages fixes et fenêtres
 ouvrant vers l'intérieur

**Janisol Arte steel
 optimised
 Triple insulating glazing**

Fixed lights and
 windows inward opening

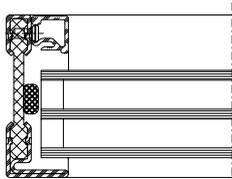
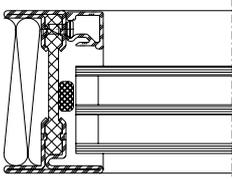
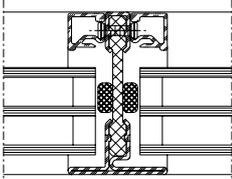
	Füllelementstärken Éléments de remplissages Infill elements ≥ 46 mm	
	Dämmprofil Glasfalz Profilé isolant Feuillure de verre Insulation profile Glazing rebate	Dämmprofil Glas- und Rahmenfalz Profilé isolant Feuillure de verre et de cadre Insulation profile Glazing and frame rebate
	2,0 W/m²K	
	1,6 W/m²K	
	1,6 W/m²K	

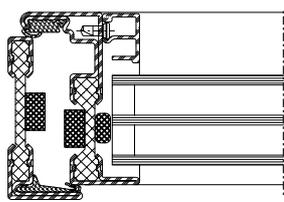
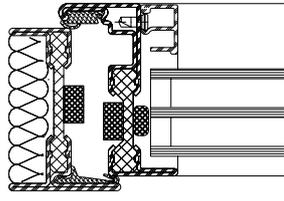
	Füllelementstärken Éléments de remplissages Infill elements ≥ 46 mm	
	Dämmprofil Glasfalz Profilé isolant Feuillure de verre Insulation profile Glazing rebate	Dämmprofil Glas- und Rahmenfalz Profilé isolant Feuillure de verre et de cadre Insulation profile Glazing and frame rebate
	3,0 W/m²K	2,5 W/m²K
	2,6 W/m²K	2,2 W/m²K

**Janisol Arte Stahl
 optimiert
 Dreifach-Isolierglas**

Festverglasungen und
 Fenster nach innen öffnend

**Janisol Arte acier
 optimisé
 Triple verre isolant**

Vitrages fixes et fenêtres
 ouvrant vers l'intérieur

**Janisol Arte steel
 optimised
 Triple insulating glazing**

Fixed lights and
 windows inward opening

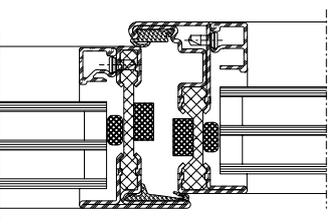
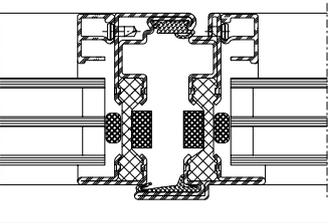
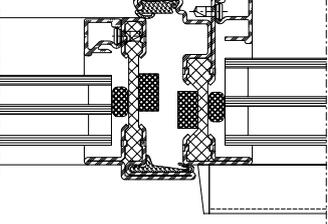
	Füllelementstärken Eléments de remplissages Infill elements ≥ 46 mm	
	Dämmprofil Glasfalz Profilé isolant Feuillure de verre Insulation profile Glazing rebate	Dämmprofil Glas- und Rahmenfalz Profilé isolant Feuillure de verre et de cadre Insulation profile Glazing and frame rebate
	2,7 W/m²K	2,2 W/m²K
	2,8 W/m²K	2,4 W/m²K
	2,7 W/m²K	2,2 W/m²K

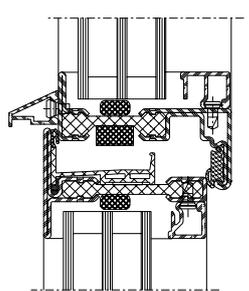
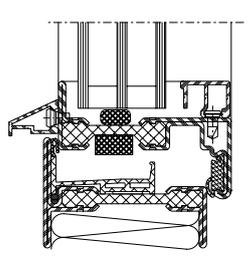
	Füllelementstärken Eléments de remplissages Infill elements ≥ 46 mm	
	Dämmprofil Glasfalz Profilé isolant Feuillure de verre Insulation profile Glazing rebate	Dämmprofil Glas- und Rahmenfalz Profilé isolant Feuillure de verre et de cadre Insulation profile Glazing and frame rebate
	2,6 W/m²K	2,4 W/m²K
	2,5 W/m²K	2,3 W/m²K

**Janisol Arte Stahl
 optimiert
 Dreifach-Isolierglas**

Festverglasungen und
 Fenster nach innen öffnend

**Janisol Arte acier
 optimisé
 Triple verre isolant**

Vitrages fixes et fenêtres
 ouvrant vers l'intérieur

**Janisol Arte steel
 optimised
 Triple insulating glazing**

Fixed lights and
 windows inward opening

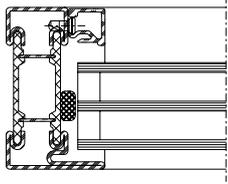
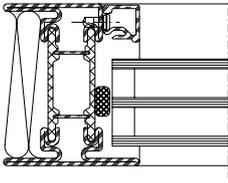
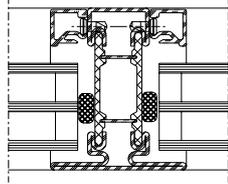
	Füllelementstärken Eléments de remplissages Infill elements ≥ 46 mm	
	Dämmprofil Glasfalz Profilé isolant Feuillure de verre Insulation profile Glazing rebate	Dämmprofil Glas- und Rahmenfalz Profilé isolant Feuillure de verre et de cadre Insulation profile Glazing and frame rebate
	1,6 W/m²K	
	1,4 W/m²K	
	1,4 W/m²K	

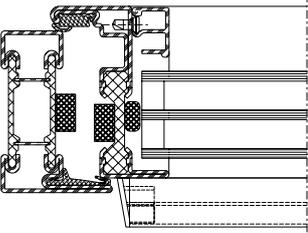
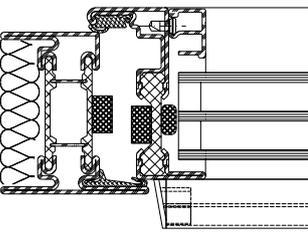
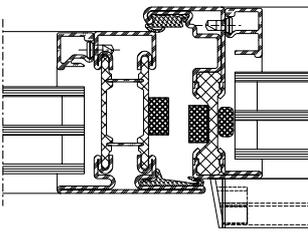
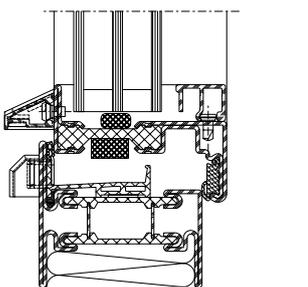
	Füllelementstärken Eléments de remplissages Infill elements ≥ 46 mm	
	Dämmprofil Glasfalz Profilé isolant Feuillure de verre Insulation profile Glazing rebate	Dämmprofil Glas- und Rahmenfalz Profilé isolant Feuillure de verre et de cadre Insulation profile Glazing and frame rebate
	2,6 W/m²K	2,2 W/m²K
	2,3 W/m²K	1,9 W/m²K
	2,4 W/m²K	2,0 W/m²K
	2,3 W/m²K	2,0 W/m²K



Schalldämmung

Ausführungsvarianten
Die nachfolgende Typenübersicht ergibt einen Überblick über die beurteilten Varianten.

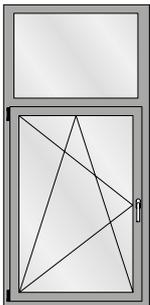
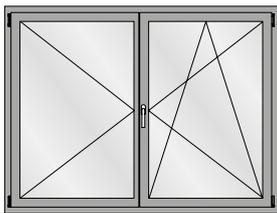
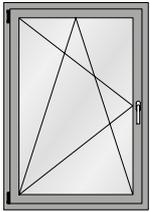

Isolation phonique

Modèles
L'aperçu des types suivant fournit une vue d'ensemble des variantes examinées.

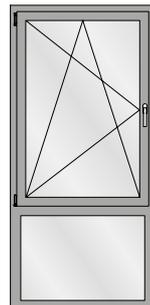
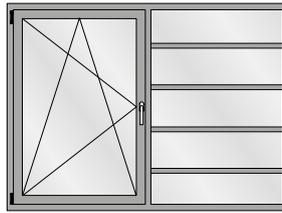
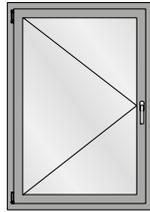

Sound insulation

Design range
The following overview of types provides an overview of the evaluated designs.



Tabelle
 Korrekturtabelle für Janisol Arte 66
 Fenster mit Mehrscheiben-Isolierglas

Tableau A1
 Tableau de correction pour les
 fenêtres Janisol Arte 66 avec vitrage
 isolant multi-vitres

Table A1
 Correction table for Janisol Arte 66
 windows with multi-pane insulating
 glass

	1	2	7	8	9	10	12	13	14	
	Fenster Fenêtre Window	Glas Verre Glass	Korrekturen Corrections Corrections							
	R_{W Fenster} dB	R_{W, P, Glas} dB	K_{FF} dB	K_{G 0,4} dB	K_{GK 0,7/A1,0} dB	K_{GK 1,1/A1,8} dB	K_{G 1,8} dB	K_{G 2,9} dB	K_{G 3,7} dB	
1	29	28	0	0	-2	-2	-2	-3	-4	
2	30	29	0	0	-2	-2	-2	-3	-4	
3	31	30	0	0	-2	-2	-2	-3	-4	
4	32	31	0	0	-2	-2	-2	-3	-4	
5	33	32	0	0	-2	-2	-2	-3	-4	
6	33	33	0	0	-2	-2	-2	-3	-4	
7	34	34	0	0	-2	-2	-2	-3	-4	
8	35	35	0	0	-2	-2	-2	-3	-4	
9	36	36	0	0	-2	-2	-2	-3	-4	
10	37	37	0	0	-2	-2	-2	-3	-4	
11	38	38	0	0	-2	-2	-2	-3	-4	
12	39	39	0	0	-2	-2	-2	-3	-4	
13	40	40	0	0	-2	-2	-2	-4	-4	
14	41	41	0	-1	-2	-2	-2	-4	-4	
15	42	42	0	-1	-2	-2	-2	-4	-4	
16	43	43	0	-2	-2	-2	-2	-4	-4	
17	44	44	0	-2	-2	-2	-2	-4	-4	
18	45	45	0	-3	-3	-3	-2	-4	-4	
19	45	46	0	-4	-3	-3	-4	-5	-5	
20	46	47	+1	-4	-3	-3	-5	-5	-6	
21	46	48	+1	-5	-3	-3	-5	-5	-6	
22	47	49	+2	-5	-3	-3	-5	-5	-6	

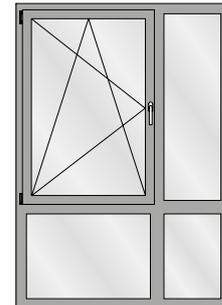
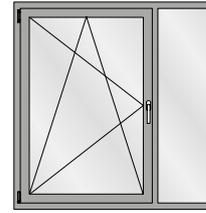
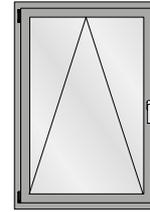
Der aus der Tabelle A1 abzulesende Wert für die Schalldämmung $R_{W, Fenster}$ beträgt:

La valeur à relever sur le tableau A1 concernant l'isolement contre les sons aériens $R_{W, Fenêtre}$ est la suivante:

The value taken from table A1 for the sound insulation $R_{W, Window}$ is:

$$R_{W, Fenster} = R_W + K_{FF} + K_{G 0,4} + K_{GK 0,7/A1,0} + K_{GK 1,1/A1,8} + K_{G 1,8} + K_{G 2,9} + K_{G 3,7} \text{ dB}$$

K_{FF}	Korrekturwert für Festverglasungen	K_{FF}	Valeur de correction pour vitrages fixes	K_{FF}	Correction value for fixed glazings
$K_{G 0,4}$	Korrekturwert für Einzelscheiben $\leq 0,4 \text{ m}^2$.	$K_{G 0,4}$	Valeur de correction pour vitres individuelles $\geq 0,4 \text{ m}^2$	$K_{G 0,4}$	Correction value for single panes $\leq 0,4 \text{ m}^2$.
$K_{GK 0,7/A1,0}$	Korrekturwert für Elemente mit Einzelscheiben mit einer Kantenlänge $\leq 0,7 \text{ m}$ und einer Fläche $\geq 1,0 \text{ m}^2$	$K_{GK 0,7/A1,0}$	Valeur de correction pour éléments à vitre individuelle avec une longueur de bord $\leq 0,7 \text{ m}$ et une surface $\geq 1,0 \text{ m}^2$	$K_{GK 0,7/A1,0}$	Correction value for units with single panes with an edge length $\leq 0.7 \text{ m}$ and an area $\geq 1.0 \text{ m}^2$
$K_{GK 1,1/A1,8}$	Korrekturwert für Elemente mit Einzelscheiben mit einer Kantenlänge $\leq 1,1 \text{ m}$ und einer Fläche $\geq 1,8 \text{ m}^2$ und $\leq 3,4 \text{ m}^2$	$K_{GK 1,1/A1,8}$	Valeur de correction pour éléments à vitre individuelle avec une longueur de bord $\leq 1,1 \text{ m}$ et une surface $\geq 1,8 \text{ m}^2$ et $\leq 3,4 \text{ m}^2$	$K_{GK 1,1/A1,8}$	Correction value for units with single panes with an edge length $\leq 1.1 \text{ m}$ and an area $\geq 1.8 \text{ m}^2$ and $\leq 3.4 \text{ m}^2$
$K_{G 1,8}$	Korrekturwert für Einzelscheiben mit einer Glasfläche $\geq 1,8 \text{ m}^2$	$K_{G1,8}$	Valeur de correction pour vitres individuelles avec surface vitrée $\geq 1,8 \text{ m}^2$	$K_{G1,8}$	Correction value for single panes with a glass area $\geq 1,8 \text{ m}^2$
$K_{G 2,9}$	Korrekturwert für Einzelscheiben mit einer Glasfläche $\geq 2,9 \text{ m}^2$	$K_{G2,9}$	Valeur de correction pour vitres individuelles avec surface vitrée $\geq 2,9 \text{ m}^2$	$R_{G2,9}$	Correction value for single panes with a glass area $\geq 2,9 \text{ m}^2$
$K_{G3,7}$	Korrekturwert für Einzelscheiben mit einer Glasfläche $\geq 3,7 \text{ m}^2$ und $\leq 5,5 \text{ m}^2$	$R_{G3,7}$	Valeur de correction pour vitres individuelles avec surface vitrée $\geq 3,7 \text{ m}^2$ et $\leq 5,5 \text{ m}^2$	$R_{G3,7}$	Correction value for single panes with a glass area $\geq 3,7 \text{ m}^2$ and $\leq 5,5 \text{ m}^2$