

Jansen-Economy 50 Fenster

Einbruchhemmung nach EN 1627

Fenêtres Jansen-Economy 50

Anti-effraction selon EN 1627

Jansen-Economy 50 windows

Burglar resistance according to EN 1627

Systemschnitt
Coupe du système
System cross-section

Economy 50 Fenster einbruchhemmend
Fenêtres Economy 50 anti-effraction
Economy 50 windows burglar resistant

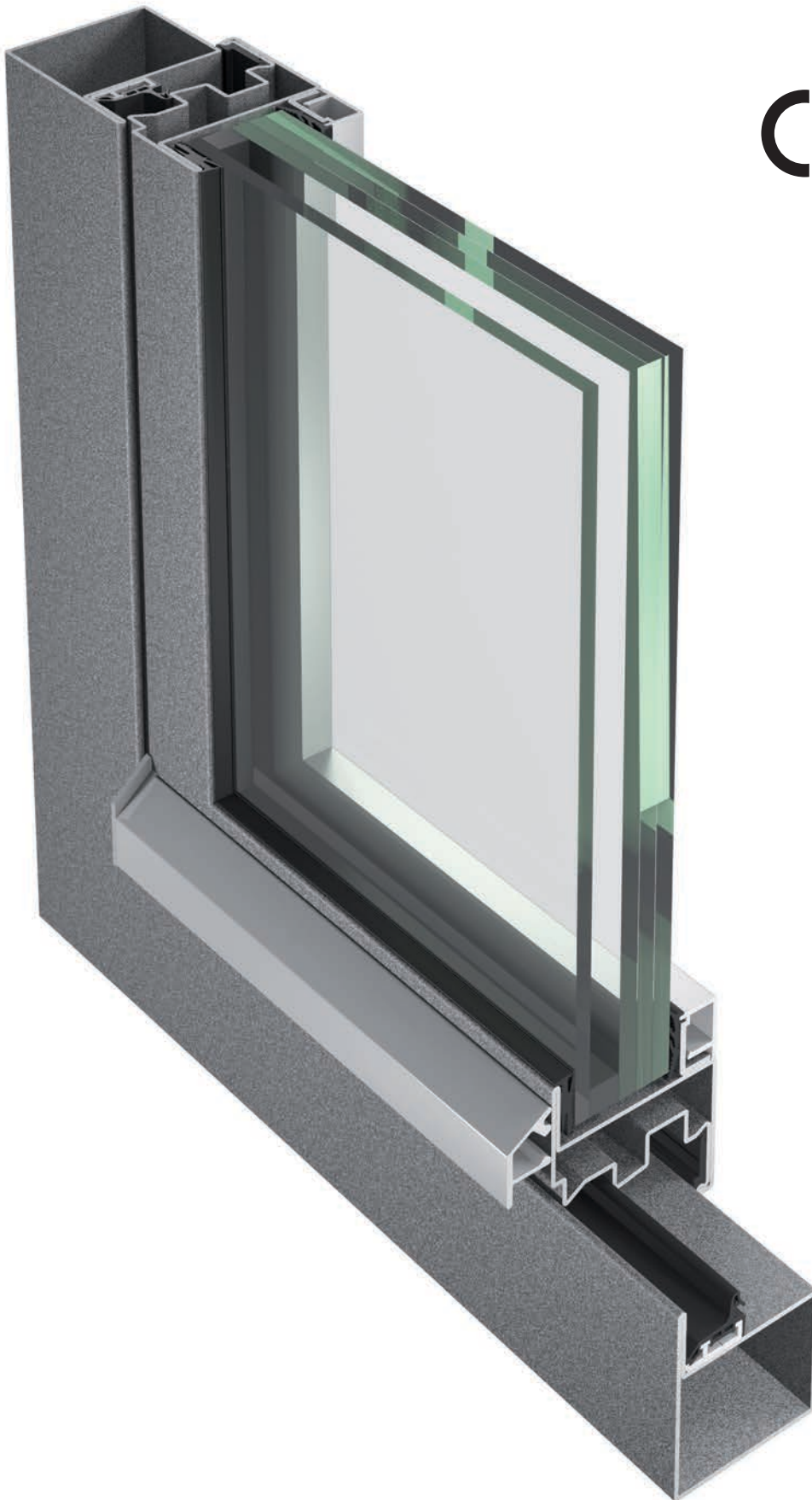

CE

Systemübersicht Zulassungen/Prüfungen	Sommaire du système Homologations/Essais	Summary of system Authorisations/Tests	2
---	--	--	----------

Zubehör Profilübersicht Beschlüge Verarbeitungshilfen	Accessoires Sommaire des profilés Ferrures Outils d'usinage	Accessories Summary of profiles Fittings Assembly tools	4
---	---	---	----------

Schnittpunkte Anwendungsbeispiele	Coupe de détails Exemples d'application	Section details Examples of applications	25
---	---	--	-----------

Beschlageinbau	Montage des ferrures	Installation of fittings	33
-----------------------	-----------------------------	---------------------------------	-----------

Verarbeitungs-Hinweise	Indications d'usage	Assembly instructions	39
-------------------------------	----------------------------	------------------------------	-----------

Alle Ausführungen dieser Dokumentation haben wir sorgfältig und nach bestem Wissen zusammengestellt. Wir können aber keine Verantwortung für die Benützung der vermittelten Vorschläge und Daten übernehmen. Wir behalten uns technische Änderungen ohne Vorankündigung vor.
Aktuelle Version auf www.jansen.com

Nous avons apporté le plus grand soin à l'élaboration de cette documentation. Cependant, nous déclinons toute responsabilité pour l'utilisation faite de nos propositions et de nos données.
Nous nous réservons le droit de procéder à des modifications techniques sans préavis.
Version actuelle sur www.jansen.com

All the information contained in this documentation is given to the best of our knowledge and ability. However, we decline all responsibility for the use made of these suggestions and data.
We reserve the right to effect technical modifications without prior warning.
Current version available at www.jansen.com

**Einbruchhemmung
nach EN 1627:2011**

RC 3 mit P5A oder P6B nach EN 356
RC 2 mit P4A nach EN 356
(GAS 13-001373-PR07 vom
23.06.2014 ift Rosenheim/DE)

**Effet anti-effraction
selon EN 1627:2011**

RC 3 avec P5A ou P6B selon EN 356
RC 2 avec P4A selon EN 356
(GAS 13-001373-PR07 du
23.06.2014 ift Rosenheim/DE)

**Burglar resistance according to
EN 1627:2011**

RC 3 with P5A or P6B according to
EN 356
RC 2 with P4A according to EN 356
(GAS 13-001373-PR07 du
23.06.2014 ift Rosenheim/DE)

Die Vorschriften bzw. Bestimmungen
der verschiedenen Länder sind zu
beachten.

Il convient de respecter les
prescriptions et règlements des
divers pays concernés.

The regulations and bye-laws in
force in the particular country must
be respected.

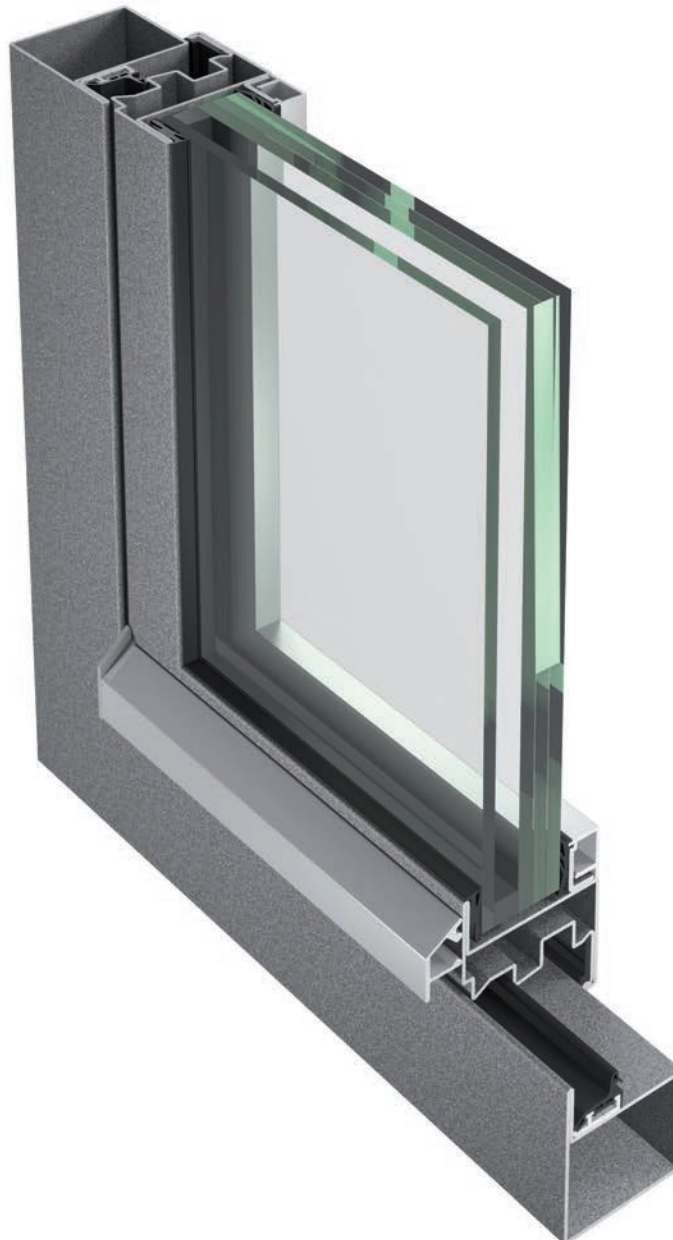

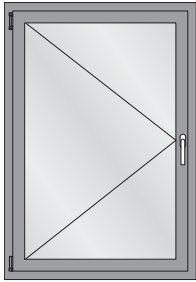

Drehflügel
Fenêtre à la française
Side-hung window

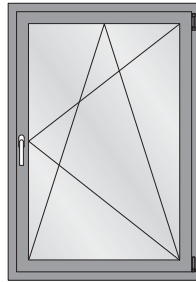

Drehkipp-Flügel
Vantail oscillo-battant
Tilt-turn window

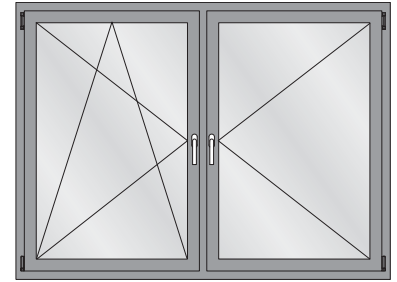

Drehkipp/Dreh-Flügel
Vantail oscillo-battant/fenêtre à la française
Side-hung/tilt-turn window

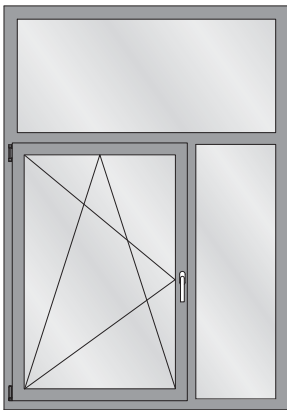

Fenster Drehkipp mit Oberlicht
Vantail oscillo-battant avec imposte
Window, tilt-turn with top light

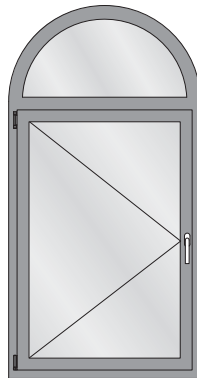

Einflügeliges Fenster mit Rundbogen-Oberlicht
Fenêtre à la française avec imposte demi-rond
Side hung window with round arched top light

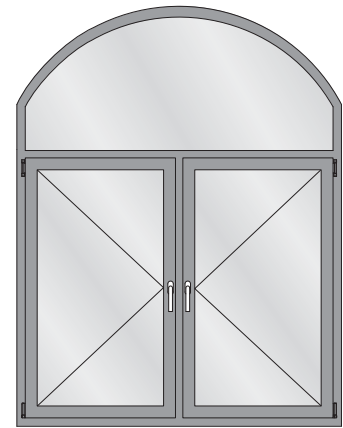

Zweiflügeliges Fenster mit Stichbogen-Oberlicht
Fenêtre à deux vantaux avec imposte en arc bombé
Double leaf window segmental arched top light

Profilübersicht

Sommaire des profilés

Summary of profiles

Economy 50 Fenster einbruchhemmend

Fenêtres Economy 50 anti-effraction

Economy 50 windows burglar resistant

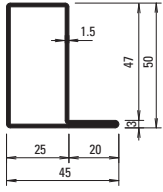

01.534
01.534 Z
 01.534.01*
 01.534.03*
 01.534.05*
 01.534.07*

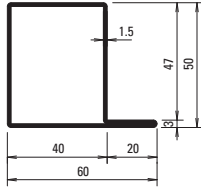

01.564
01.564 Z
 01.564.01*
 01.564.03*
 01.564.05*
 01.564.07*

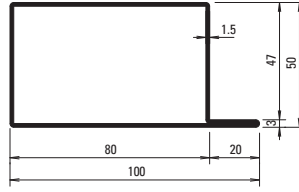

01.592
01.592 Z

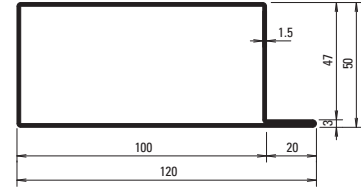

01.596
01.596 Z

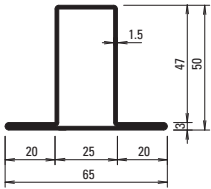

02.534
02.534 Z
 02.534.01*
 02.534.03*
 02.534.05*
 02.534.07*

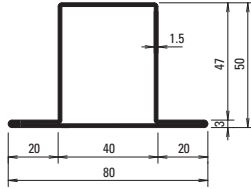

02.564
02.564 Z
 02.564.01*
 02.564.03*
 02.564.05*
 02.564.07*

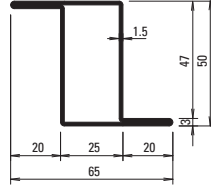

03.534
03.534 Z
 03.534.01*
 03.534.03*
 03.534.05*
 03.534.07*

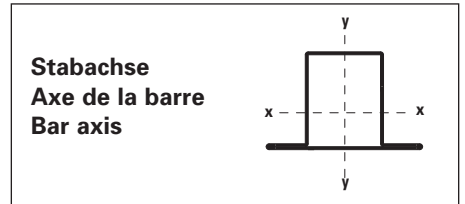

Profil-Nr.	G kg/m	F cm ²	I _x cm ⁴	W _x cm ³	I _y cm ⁴	W _y cm ³	U m ² /m
01.534	2,130	2,71	9,35	3,11	4,78	1,73	0,185
02.534	2,590	3,30	10,99	3,30	8,56	2,63	0,224
03.534	2,590	3,30	13,28	5,13	8,56	2,63	0,224
01.564	2,490	3,17	12,10	4,12	11,20	3,25	0,216
02.564	2,950	3,75	13,90	4,31	17,60	4,40	0,255
01.592	3,430	4,37	19,35	6,86	46,90	8,80	0,296
01.596	3,900	4,97	22,93	8,25	77,23	12,30	0,336

Profil-Nr.	G kg/m	F cm ²	I _x cm ⁴	W _x cm ³	I _y cm ⁴	W _y cm ³	U m ² /m
02.636	2,450	3,11	12,10	3,04	3,30	1,32	0,212
05.568	3,620	4,65	20,62	7,37	32,39	6,55	0,315
30.900	3,100	3,98	19,29	6,20	8,36	2,64	0,269
400.048	2,050	2,58	9,46	3,78	6,70	3,35	0,177

Gewichte für Edelstahl-Profile siehe Seite 5
 Poids pour profilés en acier Inox voir page 5
 Weights for stainless steel profiles see page 5

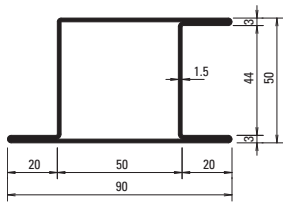

05.568
05.568 Z
 05.568.01*
 05.568.03*
 05.568.05*
 05.568.07*

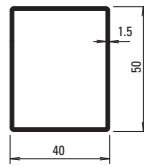

400.048
400.048 GV+GC

* Gewichte für Edelstahl-Profile
 * Poids pour profilés en acier Inox
 * Weights for stainless steel profiles

01.534.01 = 2,153 kg/m	01.534.05 = 2,126 kg/m
02.534.01 = 2,622 kg/m	02.534.05 = 2,590 kg/m
01.564.01 = 2,513 kg/m	01.564.05 = 2,481 kg/m
02.564.01 = 2,975 kg/m	02.564.05 = 2,938 kg/m
03.534.01 = 2,622 kg/m	03.534.05 = 2,590 kg/m
05.568.01 = 3,672 kg/m	05.568.05 = 3,640 kg/m
30.900.01 = 3,120 kg/m	30.900.05 = 3,081 kg/m

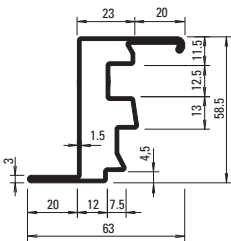

30.900
30.900 Z
 30.900.01*
 30.900.03*
 30.900.05*
 30.900.07*

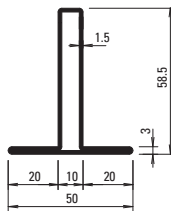

02.636
02.636 GV+GC

Artikelbibliothek
 Bibliothèque des articles
 Article library

DXF **DWG**

Oberfläche/Werkstoff

Artikel-Nr.

- ohne Zusatz** = blank
- mit Z** = Bandverzinkter Stahl
- mit GV+GC** = aussen galvanisch verzinkt und gelbchromatiert
- mit 01** = Edelstahl, blank
Werkstoff 1.4404 (AISI 316L)
- mit 03** = Edelstahl geschliffen
Korn 220-240
Werkstoff 1.4404 (AISI 316L)
- mit 05** = Edelstahl, blank
Werkstoff 1.4307 (AISI 304L)
- mit 07** = Edelstahl geschliffen
Korn 220-240
Werkstoff 1.4307 (AISI 304L)

Surface/Matériau

No. d'article

- sans supplément** = brut
- avec Z** = en bandes d'acier zinguées au feu
- avec GV+GC** = zingués galvanique à l'extérieur et chromatisé jaune
- avec 01** = Acier Inox, brut
matériau 1.4404 (AISI 316L)
- avec 03** = Acier Inox, polies
grain 220-240
matériau 1.4404 (AISI 316L)
- avec 05** = Acier Inox, brut
matériau 1.4307 (AISI 304L)
- avec 07** = Acier Inox, polies
grain 220-240
matériau 1.4307 (AISI 304L)

Surface/Material

Part no.

- without addition** = bright
- with Z** = made from hot-dip galvanised strip
- with GV+GC** = outside galvanised and yellow chromated
- with 01** = Stainless steel, bright
material 1.4404 (AISI 316L)
- with 03** = Stainless steel polished, grain 220-240
material 1.4404 (AISI 316L)
- with 05** = Stainless steel, bright
material 1.4307 (AISI 304L)
- with 07** = Stainless steel polished, grain 220-240
material 1.4307 (AISI 304L)

Glasleisten (Massstab 1:2)

Parcloses (échelle 1:2)

Glazing beads (scale 1:2)

Economy 50 Fenster einbruchhemmend

Fenêtres Economy 50 anti-effraction

Economy 50 windows burglar resistant

**Stahl-Glasleisten aus
bandverzinktem Stahl (Länge 6 m)**

**Parcloses en acier en bandes d'acier
zinguées au feu (longueur 6 m)**

**Steel glazing beads made of hot-dip
galvanised strip (length 6 m)**

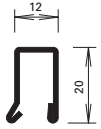

402.112 Z

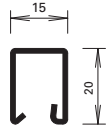

402.115 Z

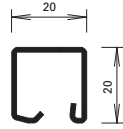

402.120 Z

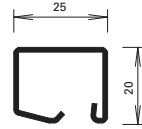

402.125 Z

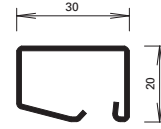

402.130 Z

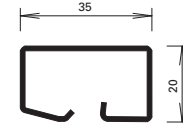

402.135 Z



450.007

Befestigungsknopf

VE = 50 Magazine à 10 Knöpfe

Bouton de fixation

UV = 50 magasins à 10 pièces

Fastening stud

PU = 50 magazines with 10 studs



450.008

Befestigungsknopf

VE = 400 Magazine à 10 Knöpfe

Bouton de fixation

UV = 400 magasins à 10 pièces

Fastening stud

PU = 400 magazines with 10 studs



450.006

Befestigungsknopf (kurz) SR1

Bohrdurchmesser \varnothing 3,5 mm

VE = 100 Stück

Bouton de fixation (court) SR1

Diamètre de perçage \varnothing 3,5 mm

UV = 100 pièces

Fastening stud (short) SR1

Hole diameter \varnothing 3,5 mm

PU = 100 pieces

**Winkelkontur-Stahl-Glasleisten
(Länge ca. 6 m)**

**Parcloses en acier à contour angulaire
(longueur env. 6 m)**

**Angle contour steel glazing beads
(length approx. 6 m)**

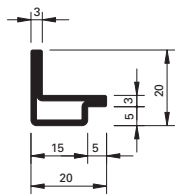

62.507 GV+GC

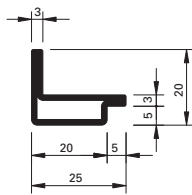

62.508 GV+GC

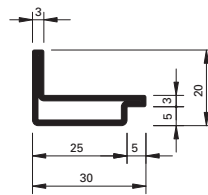

62.509 GV+GC

GV+GC = aussen galvanisch verzinkt
ca. 15 μ m und
gelbchromatiert
(EN 12329 – Fe//Zn15//C)

GV+GC = zingués galvanique
env. 15 μ m à l'extérieur
et chromatisé jaune
(EN 12329 – Fe//Zn15//C)

GV+GC = outside galvanised
approx. 15 μ m and
yellow chromated
(EN 12329 – Fe//Zn15//C)

Glasleisten (Massstab 1:2)
Parcloses (échelle 1:2)
Glazing beads (scale 1:2)

Economy 50 Fenster einbruchhemmend
 Fenêtres Economy 50 anti-effraction
 Economy 50 windows burglar resistant

Edelstahl-Glasleisten
(1.4401 / 1.4301)
Länge 6 m

Parcloses en acier Inox
(AISI 316 / AISI 304)
Longueur 6 m

Stainless steel glazing beads
(AISI 316 / AISI 304)
Length 6 m

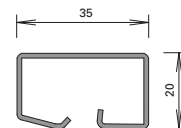
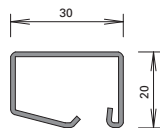
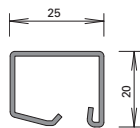
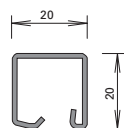
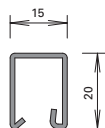

402.515
402.515.03
 402.415
 402.415.07

402.520
402.520.03
 402.420
 402.420.07

402.525
402.525.03
 402.425
 402.425.07

402.530
402.530.03
 402.430
 402.430.07

402.535
402.535.03

Oberfläche:
03/07: geschliffen, Korn 220-240

Surface:
03/07: polies, grain 220-240

Surface:
03/07: polished, grain 220-240



450.025

Befestigungsknopf

Edelstahl, gewindeformend,
 mit SR1-Angriff,
 Bohrdurchmesser 3,5 mm

VE = 100 Stück

450.025

Bouton de fixation

en acier inox, formant le taraudage,
 avec empreinte SR1,
 diamètre de perçage 3,5 mm

UV = 100 pièces

450.025

Fastening stud

stainless steel, self-tapping,
 with SR1 head,
 hole diameter 3,5 mm

PU = 100 pieces

Artikel-Nr.	G kg/m	B m ² /m
402.112 Z	0,550	0,062
402.115 Z	0,600	0,066
402.120 Z	0,670	0,074
402.125 Z	0,740	0,083
402.130 Z	0,844	0,092
402.135 Z	0,960	0,103

Artikel-Nr.	G kg/m	P m ² /m
402.515 / 415	0,590	0,035
402.520 / 420	0,680	0,040
402.525 / 425	0,760	0,045
402.530 / 430	0,850	0,050
402.535	0,960	0,055

Artikel-Nr.	G kg/m	B m ² /m
62.507	0,840	0,076
62.508	0,960	0,086
62.509	1,090	0,096

G = Gewicht
 B = Beschichtungsfläche
 U = Abwicklung umlaufend
 P = Polierabwicklung

G = Poids
 B = Surface à traiter
 U = Périmètre extérieur
 P = Périmètre à polir

G = Weight
 B = Coated surface
 U = Circumferential development
 P = Circumferential polishing

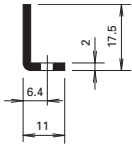

400.021 Z

Stahlwinkel
feuerverzinkter Bandstahl,
gestanzt, Langloch (12x4,5 mm)
alle 150 mm, 0,410 kg/m

Länge 6 m

400.021 Z

Cornière
bandes d'acier zinguées au feu,
perforées avec trou oblong
(12x4,5 mm) tous les 150 mm,
0,410 kg/m

Longueur 6 m

400.021 Z

Steel angle
hot-dip galvanised steel strip,
perforated, oblong hole
(12x4.5 mm) every 150 mm,
0,410 kg/m

Length 6 m

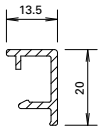

406.999

Aluminium-Abdeckleiste
zum Abdecken des Stahlwinkels
400.021 Z, 0,166 kg/m

U = 0,089 m²/m
P = 0,034 m²/m

Länge 6 m

406.999

Parclose en aluminium
pour recouvrir la cornière
400.021 Z, 0,166 kg/m

U = 0,089 m²/m
P = 0,034 m²/m

Longueur 6 m

406.999

Aluminium cover strip
for covering steel angle
400.021 Z, 0,166 kg/m

U = 0,089 m²/m
P = 0,034 m²/m

Length 6 m

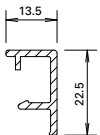

406.997

Aluminium-Abdeckleiste
zum Abdecken des Stahlwinkels
400.021 Z, 0,176 kg/m

U = 0,094 m²/m
P = 0,036 m²/m

Länge 6 m

406.997

Parclose en aluminium
pour recouvrir la cornière
400.021 Z, 0,176 kg/m

U = 0,094 m²/m
P = 0,036 m²/m

Longueur 6 m

406.997

Aluminium cover strip
for covering steel angle
400.021 Z, 0,176 kg/m

U = 0,094 m²/m
P = 0,036 m²/m

Length 6 m



450.023

Befestigungsfeder
Edelstahl, mit selbstgewindender
Schraube, mit SR1-Angriff,
für Aluminium-Abdeckleiste
406.999, Bohrdurchmesser
3,5 mm

VE = 100 Stück

450.023

Ressort de fixation
acier Inox, avec vis auto-
taraudeuse, avec empreinte SR1,
pour parclose en aluminium
406.999, diamètre de perçage
3,5 mm

UV = 100 pièces

450.023

Fastening spring
Stainless steel, with self-tapping
screw, with SR1 head, for
aluminium cover strip 406.999,
hole diameter 3,5 mm

PU = 100 pieces



450.024

Schraube M4x7
Stahl verzinkt, selbstgewindend,
mit SR1-Angriff,
für Stahlwinkel 400.021 Z.
Bohrdurchmesser 3,5 mm

VE = 100 Stück

450.024

Vis M4x7
acier zingué, autotaraudeuse,
avec empreinte SR1, pour
cornière 400.021 Z, diamètre
de perçage 3,5 mm

UV = 100 pièces

450.024

Screw M4x7
galvanised steel,
self-tapping, with SR1 head,
for steel angle 400.021 Z,
hole diameter 3,5 mm

PU = 100 pieces

Zubehör
Accessoires
Accessories

Economy 50 Fenster einbruchhemmend
Fenêtres Economy 50 anti-effraction
Economy 50 windows burglar resistant



452.496

Linsensenkschraube
ø 4,5 x 33 mm
Edelstahl, SR1-Angriff,
selbstbohrend, zur Sicherung
der Glasleisten

VE = 100 Stück

452.496

Vis à tête bombée fraisée
ø 4,5 x 33 mm
acier Inox, empreinte SR1,
autoforeuse, pour blocage
des parclozes

UV = 100 pièces

452.496

Countersunk oval-head screw
ø 4,5 x 33 mm
stainless steel, SR1 head,
self-cutting, for glazing bead
fixing

PU = 100 pieces

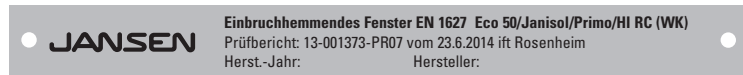

536.031

Kennzeichen-Schild
inkl. Montagebescheinigung

VE = 1 Stück

536.031

Plaque d'identification
incl. certification d'entreprise

UV = 1 pièce

536.031

Identification plate
includes fabrication certificate

PU = 1 piece

Zubehör und Beschläge

Diese Dokumentation beinhaltet lediglich die systemspezifischen Zubehör- und Beschlägeteile. Weitere allgemein einsetzbare Beschläge und Zubehör-Artikel finden Sie im Katalog «Nichtisolierte Fenster und Türen» Kapitel Jansen-Economy 50 Fenster.

Sie haben die Möglichkeit, diesen Katalog als PDF-Datei herunterzuladen.
www.jansen.com

Accessoires et ferrures

La documentation ne comprend que les accessoires et les ferrures spécifiques au système. Vous trouverez d'autres ferrures et accessoires d'utilisation générale dans le catalogue «Portes et fenêtres non-isolés» au chapitre Fenêtres Jansen-Economy 50.

Vous pouvez télécharger le catalogue au format PDF.
www.jansen.com

Accessories and fittings

This documentation contains only the system-specific accessories and fittings. For more fittings and accessories for general use, please consult the Jansen-Economy 50 windows section in the «Non insulated doors and windows» catalogue.

You can download this manual as a PDF file at www.jansen.com



Beschläge

Ferrures

Fittings

Economy 50 Fenster einbruchhemmend

Fenêtres Economy 50 anti-effraction

Economy 50 windows burglar resistant

Folgende technische Rahmenbedingungen müssen beachtet werden:

Allgemein:

Max. Gewicht: bis 150 kg

Max. Fläche: 3.0 m²

Max. Seitenverhältnis

FFB/FFH: ≤ 2:1

G-Mass min.: 260 mm

Min. 13 Verriegelungspunkte

Maximal Verriegelungsabstand:

672 mm

Les conditions cadres techniques suivantes doivent être observées:

Généralités:

Poids max.: jusqu'à 150 kg

Surface max.: 3.0 m²

Rapport latéral max.

largeur/hauteur FFB/FFH: ≤ 2:1

Mesure G min.: 260 mm

Min. 13 points de verrouillage

Distance de verrouillage maximale:

672 mm

The following technical limiting conditions must be duly considered:

General:

Max. weight: to 150 kg

Max. surface: 3.0 m²

Max. ratio

width/height FFB/FFH: ≤ 2:1

G-measurement min.: 260 mm

Min. 13 locking points

Maximum distance between locking

points: 672 mm

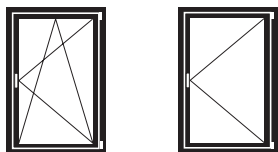

Flügelgrößen Drehkipp- und Drehfenster:

Max. FFH = 2300 mm
FFB = 1475 mm

Min. FFH = 830 mm
FFB = 630 mm

Grandeurs du vantail fenêtre oscillo-battante et à la française:

Max. FFH = 2300 mm
FFB = 1475 mm

Min. FFH = 830 mm
FFB = 630 mm

Size of leafs tilt-turn and side-hung windows:

Max. FFH = 2300 mm
FFB = 1475 mm

Min. FFH = 830 mm
FFB = 630 mm

Max. Gewicht für Dreh- und Drehkipp-Fenster in Abhängigkeit Verhältnis Flügelfalzbreite (FFB) / Flügelfalzhöhe (FFH)

Poids maximal pour les fenêtres à la française et oscillo-battantes en fonction du rapport largeur de feuillure du vantail (FFB) / hauteur de feuillure du vantail (FFH)

Max. weight for side-hung and tilt-turn windows dependent on the relationship between leaf rebate width (FFB) / leaf rebate height (FFH)

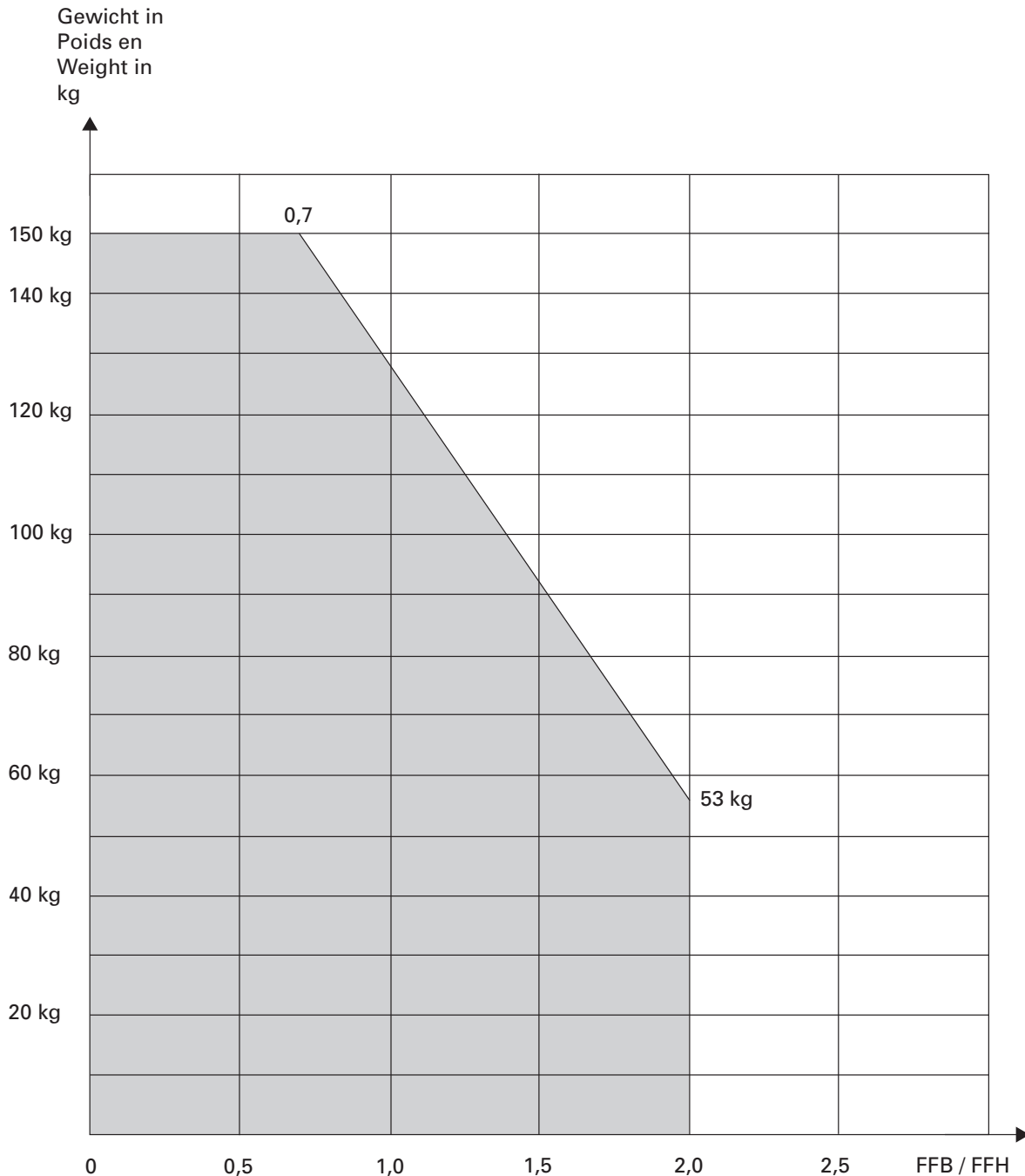

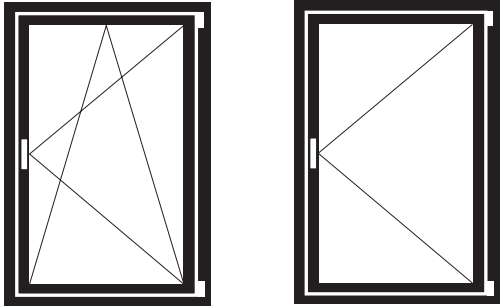

**Drehkipp- und
 Drehbeschlag**

**Ferrure oscillo-battante
 et à la française**

**Tilt-turn and
 side-hung fitting**

Bestellschema

Tableau de commande

Order chart

1. FFH, FFB, G-Mass und
 Öffnungsrichtung bestimmen

2. Basisbeschlag auswählen

3. Grössenabhängige
 Beschlagsteile auswählen

4. Befestigungsmaterial auswählen

5. Fenstergriff auswählen

6. Bohrlehren auswählen

1. Choisir FFH, FFB, la mesure G et
 l'orientation de l'ouverture

2. Choisir la ferrure de base

3. Choisir les pièces de ferrures en
 fonction de la grosseur

4. Définir le matériel de fixation

5. Choisir la poignée

6. Choisir des outils d'usinage

1. Determine the FFH, FFB, G mea-
 surement and opening direction

2. Select basic fittings

3. Select fittings depending
 on size

4. Select fixing material

5. Select handle

6. Select drilling jigs

Zusätzlich bestellen:

- Beim Drehflügel zusätzlich zum Drehkippbeschlag Anschlagplatte 599.400 bestellen

Commander séparément:

- Commander une plaque-butée 599.400 en plus de la ferrure oscillo-battante pour l'ouvrant à la française

Order separately:

- For side-hung vents, order stop plate 599.400 in addition to the turn/tilt fitting

1. FFH, FFH, G-Mass und Öffnungsrichtung bestimmen

1. Choisir FFH, FFH, la mesure G et l'orientation de l'ouverture

1. Determine the vent rebate height (FFH), vent rebate width (FFB), G measurement and opening direction

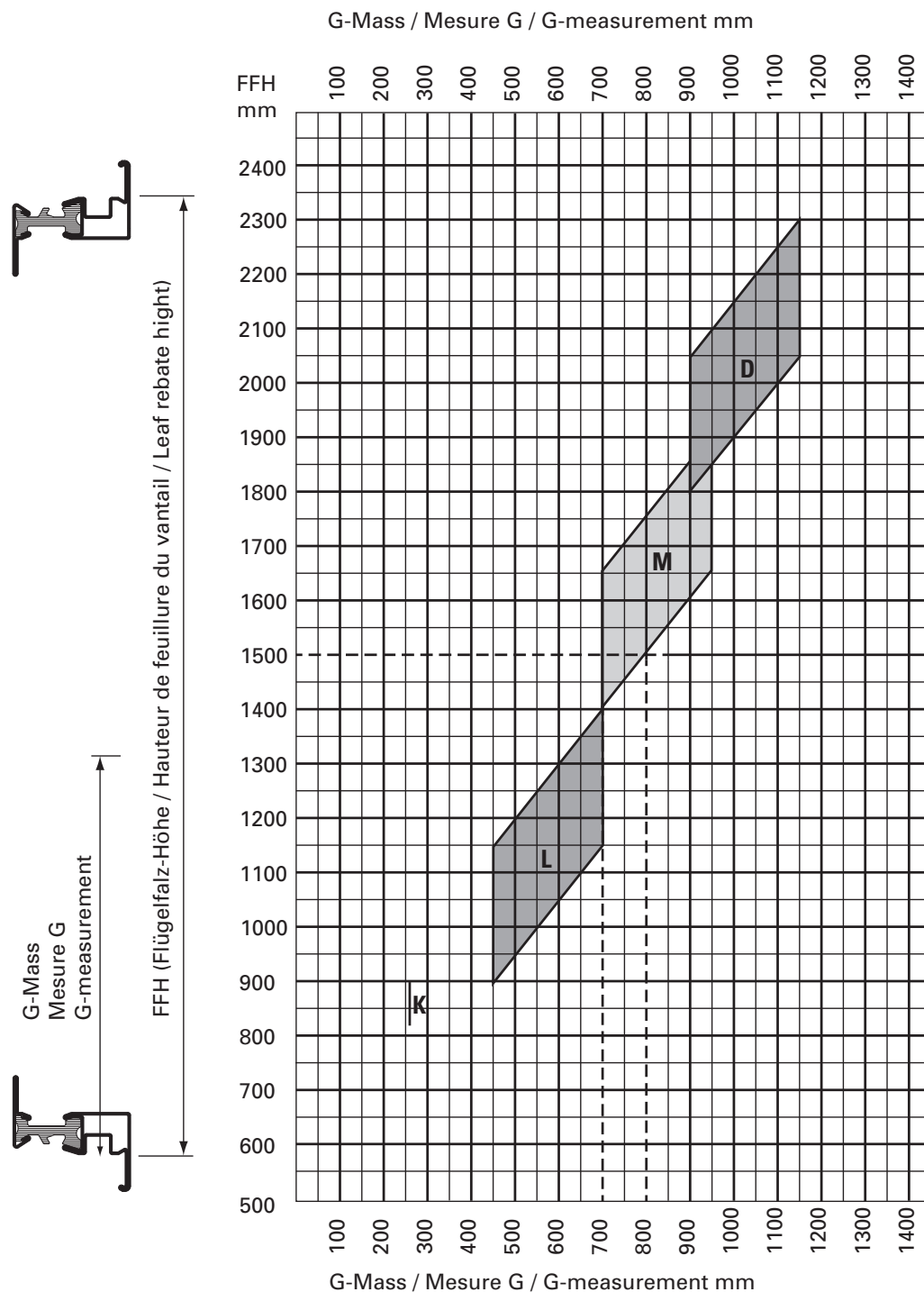

Beispiel:
 FFH 1500 mm
 G-Mass
 von 700 mm bis 800 mm

Exemple:
 FFH 1500 mm
 Mesure G de
 700 mm à 800 mm

Example:
 FFH 1500 mm
 G measurement from
 700 mm to 800 mm

**K Einbau Fehlschalt-
 sicherung nicht möglich**

**K Montage anti-fausse
 manoeuvre pas possible**

**K Installation fool-proof
 mechanism not possible**

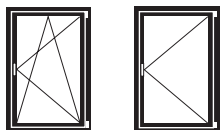

2. Basisbeschlag auswählen

558.005

Basisbeschlag RC Drehkipp-Beschlag, DIN links

VE = 1 Garnitur bestehend aus:

2 Eckumlenkungen E11	599.486
1 Anbohrschutz G.D.7,5	599.485
1 Eckumlenkung ECKUML.E1.FWSB.18-9-12.LS	599.487
1 Ecklager ESV 6-3-16 SL	599.428
1 Unterlage Ecklager	599.533
1 Flügellagerstopfen FWV SL	599.433
1 Scherenlager SL.K.3-6.130	599.443
7 Stulpplatten ER J SL	599.425
1 Fehlschaltsicherung* FSA	599.406
2 Koppelelemente KE SL	599.491
2 Mittenverriegelungen MK.PA.250-1	599.417
1 Mittenverriegelung MK.250-1	599.413
4 Auflauf AUFLAUF D WEISS	599.531
1 Kippschliessblech SBK.S.9-18.J	599.484
6 Sicherheitsschliessbleche SBS.S.9-18.J.LS	599.482
1 Sicherheits-schliessblech RC2/3 SBS.S.9-18.J.RC-3.LS	599.534

* kann bei der Getriebebeschiene 1x599.489 GAK.830.D7,5 nicht eingesetzt werden

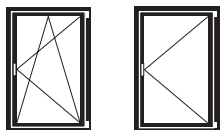

2. Choisir paquet de base

558.005

Paquet de base RC Ferrure oscillo-battante, DIN gauche

UV = 1 garniture comprenant:

2 Renvoi d'angle E11	599.486
1 Anti perçage G.D.7,5	599.485
1 Renvoi d'angle ECKUML.E1.FWSB.18-9-12.LS	599.487
1 Charnière inférieure ESV 6-3-16 SL	599.428
1 Cale charnière d'angle	599.533
1 Bouchon FWV SL	599.433
1 Bouchon SL.K.3-6.130	599.443
7 Plaques ER J SL	599.425
1 Anti-fausse manoeuvre* FSA	599.406
2 Element de liaison KE SL	599.491
2 Verrouillages central MK.PA.250-1	599.417
1 Verrouillage central MK.250-1	599.413
4 Appuis AUFLAUF D WEISS	599.531
1 Gâche oscillo-battant SBK.S.9-18.J	599.484
6 Gâche de sécurité SBS.S.9-18.J.LS	599.482
1 Gâche de sécurité RC2/3 SBS.S.9-18.J.RC-3.LS	599.534

* ne peut pas être utilisé avec crémone de tringle 1x599.407 GAM.800.D7,5

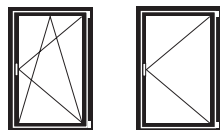

2. Select basic kit

558.005

Basic kit RC tilt-turn fitting, left-hand opening

PU = 1 set consisting of:

2 Corner guide E11	599.486
1 Anti drilling device G.D.7,5	599.485
1 Corner guide ECKUML.E1.FWSB.18-9-12.LS	599.487
1 Corner hinge part ESV 6-3-16 SL	599.428
1 Support for corner pivot	599.533
1 Vent bearing stopper FWV SL	599.433
1 Scissor hinge part SL.K.3-6.130	599.443
7 Connecting pieces ER J SL	599.425
1 Fool-proof mechanism* FSA	599.406
2 Couplings KE SL	599.491
2 Central lock MK.PA.250-1	599.417
1 Central lock MK.250-1	599.413
4 Lock staple AUFLAUF D WEISS	599.531
1 Tilt striking plate SBK.S.9-18.J	599.484
6 Security strike plate SBS.S.9-18.J.LS	599.482
1 Security strike plate RC2/3 SBS.S.9-18.J.RC-3.LS	599.534

* can not be used with mechanism rod 1x599.407 GAM.800.D7,5

Beschläge**Ferrures****Fittings**

Economy 50 Fenster einbruchhemmend

Fenêtres Economy 50 anti-effraction

Economy 50 windows burglar resistant

558.006**Basisbeschlag RC
Drehkipp-Beschlag,
DIN rechts**

VE = 1 Garnitur bestehend aus:

2 Eckumlenkungen E11	599.486
1 Anbohrschutz G.D.7,5	599.485
1 Eckumlenkung ECKUML.E1.FWSB.18-9-12.RS	599.488
1 Ecklager ESV 6-3-16 SL	599.428
1 Unterlage Ecklager	599.533
1 Flügellagerstopfen FWV SL	599.433
1 Scherenlager SL.K.3-6.130	599.443
7 Stulpplatten ER J SL	599.425
1 Fehlschaltsicherung* FSA	599.406
2 Koppellelemente KE SL	599.491
2 Mittenverriegelungen MK.PA.250-1	599.417
1 Mittenverriegelung MK.250-1	599.413
4 Auflauf AUFLAUF D WEISS	599.531
1 Kippschliessblech SBK.S.9-18.J	599.484
6 Sicherheitsschliessbleche SBS.S.9-18.J.RS	599.483
1 Sicherheits- schliessblech RC2/3 SBS.S.9-18.J.RC-3.RS	599.535

* kann bei der Getriebechiene
1x599.489 GAK.830.D7,5 nicht
eingesetzt werden

558.006**Paquet de base RC
Ferrure oscillo-battante,
DIN droite**

UV = 1 garniture comprenant:

2 Renvoi d'angle E11	599.486
1 Anti perçage G.D.7,5	599.485
1 Renvoi d'angle ECKUML.E1.FWSB.18-9-12.RS	599.488
1 Charnière inférieure ESV 6-3-16 SL	599.428
1 Cale charnière d'angle	599.533
1 Bouchon FWV SL	599.433
1 Bouchon SL.K.3-6.130	599.443
7 Plaques ER J SL	599.425
1 Anti-fausse manoeuvre* FSA	599.406
2 Element de liaison KE SL	599.491
2 Verrouillage central MK.PA.250-1	599.417
1 Verrouillage central MK.250-1	599.413
4 Appuis AUFLAUF D WEISS	599.531
1 Gâche oscillo-battant SBK.S.9-18.J	599.484
6 Gâche de sécurité SBS.S.9-18.J.RS	599.483
1 Gâche de sécurité RC2/3 SBS.S.9-18.J.RC-3.RS	599.535

* ne peut pas être utilisé avec
crémone de triangle
1x599.407 GAM.800.D7,5

558.006**Basic kit RC
tilt-turn fitting,
right-hand opening**

PU = 1 set consisting of:

2 Corner guide E11	599.486
1 Anti drilling device G.D.7,5	599.485
1 Corner guide ECKUML.E1.FWSB.18-9-12.RS	599.488
1 Corner hinge part ESV 6-3-16 SL	599.428
1 Support for corner pivot	599.533
1 Vent bearing stopper FWV SL	599.433
1 Scissor hinge part SL.K.3-6.130	599.443
7 Connecting pieces ER J SL	599.425
1 Fool-proof mechanism* FSA	599.406
2 Couplings KE SL	599.491
2 Central lock MK.PA.250-1	599.417
1 Central lock MK.250-1	599.413
4 Lock staple AUFLAUF D WEISS	599.531
1 Tilt striking plate SBK.S.9-18.J	599.484
6 Security strike plate SBS.S.9-18.J.RS	599.483
1 Security strike plate RC2/3 SBS.S.9-18.J.RC-3.RS	599.535

* can not be used with
mechanism rod
1x599.407 GAM.800.D7,5

Beschläge
Ferrures
Fittings

Economy 50 Fenster einbruchhemmend
Fenêtres Economy 50 anti-effraction
Economy 50 windows burglar resistant

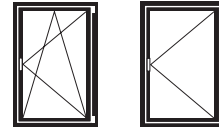
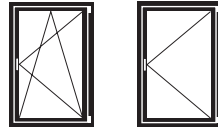
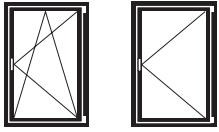

**3. Grössenabhängige
Beschlagteile auswählen**

**3. Choisir les ferrures en
fonction de la dimension**

**3. Select fittings
depending on size**

Breite unten

Largeur inférieur

Width bottom

FFB mm	Mittenverriegelung Bandseite Verrouillage central côté paumelle Central lock hinge side Nr. 6	Mittenverriegelung mittig Verrouillage central centre Central lock hinge side center Nr. 6	Sicherheitsschliessblech Gâche de sécurité Security strike plate Nr. 56
630 - 810	1 x 599.413 MK.250-1		1 x 599.482*/483** SBS.S.9-18.J.xx
811 - 1060	1 x 599.415 MK.500-1		1 x 599.482*/483** SBS.S.9-18.J.xx
1061 - 1310	1 x 599.413 MK.250-1	1 x 599.415 MK.500-1	2 x 599.482*/483** SBS.S.9-18.J.xx
1311 - 1475	1 x 599.415 MK.500-1	1 x 599.415 MK.500-1	2 x 599.482*/483** SBS.S.9-18.J.xx

Breite oben

Largeur supérieur

Width top

FFB mm	Oberschiene Tringle supérieure Top rod Nr. 3	Eckumlenkung Renvoi d'angle Corner guide Nr. 4	Mittenverriegelung Verrouillage central Central lock Nr. 6	Sicherheitsschliessblech Gâche de sécurité Security strike plate Nr. 56	Schere Compas Stay Nr. 9
630 - 775	1 x 599.434 OS1.600	1 x 599.404 E3	1 x 599.413 MK.250-1	1 x 599.482*/483** SBS.S.9-18.J.xx	1 x 599.439*/440** SK1.18-9.xx
776 - 1025	1 x 599.436 OS2.1025-1	1 x 599.403 E2		1 x 599.482*/483** SBS.S.9-18.J.xx	1 x 599.441*/442** SK2.18-9.xx
1026-1275	1 x 599.436 OS2.1025-1	1 x 599.403 E2	1 x 599.413 MK.250-1	2 x 599.482*/483** SBS.S.9-18.J.xx	1 x 599.441*/442** SK2.18-9.xx
1276 - 1475	1 x 599.436 OS2.1025-1	1 x 599.403 E2	1 x 599.415 MK.500-1	2 x 599.482*/483** SBS.S.9-18.J.xx	1 x 599.441*/442** SK2.18-9.xx

* links
** rechts

* à gauche
** à droite

* left
** right

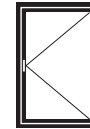
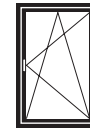
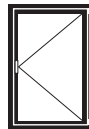
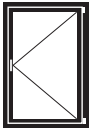
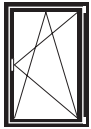

Höhe Getriebeseite

Hauteur côté crémonne

Height mechanism side

FFH mm	Getriebe Crémone Mechanism Nr. 1	G-Mass Mesure G G-measurement mm	Mittenverriegelung unten Verrouillage central inférieur Central lock bottom Nr. 6	Mittenverriegelung oben Verrouillage central supérieur Central lock top Nr. 6	Sicherheitschliessblech Gâche de sécurité Security strike plate Nr. 56
830 - 900	K 1 x 599.489 GAK.830-1.D7,5	260		1 x 599.413 MK.250-1	2 x 599.482*/483** SBS.S.9-18.J.xx
901 - 1400	L 1 x 599.490 GAM.1400-2.D7,5	450-700			2 x 599.482*/483** SBS.S.9-18.J.xx
1401 - 1800	M 1 x 599.490 GAM.1400-2.D7,5	700-950	1 x 599.413 MK.250-1	1 x 599.413 MK.250-1	4 x 599.482*/483** SBS.S.9-18.J.xx
1801 - 2300	D 1 x 599.410 GAM.1800-2.D7,5	900-1150	1 x 599.413 MK.250-1	1 x 599.413 MK.250-1	4 x 599.482*/483** SBS.S.9-18.J.xx

Höhe Bandseite

Hauteur côté paumelle

Height hinge side

FFH mm	Mittenverriegelung unten Verrouillage central inférieur Central lock bottom Nr. 6	Mittenverriegelung mittig Verrouillage central centre Central lock center Nr. 6	Mittenverriegelung oben Verrouillage central supérieur Central lock top Nr. 6	Sicherheitschliessblech Gâche de sécurité Security strike plate Nr. 56
830 - 1160				
1161 - 1560	1 x 599.413 MK.250-1			1 x 599.482*/483** SBS.S.9-18.J.xx
1561-1810	1 x 599.415 MK.500-1			1 x 599.482*/483** SBS.S.9-18.J.xx
1811-2060	1 x 599.413 MK.250-1	1 x 599.415 MK.500-1		2 x 599.482*/483** SBS.S.9-18.J.xx
2061-2300	1 x 599.415 MK.500-1		1 x 599.415 MK.500-1	2 x 599.482*/483** SBS.S.9-18.J.xx

* links
** rechts

* à gauche
** à droite

* left
** right

4. Befestigungsmaterial
auswählen

4. Choisir le matériel de
fixation

4. Select fixing material



557.045

Schraube M4x20

Stahl verzinkt, SR1-Angriff,
selbstgewindend, für
Beschlagteile Flügelrahmen

Bohrdurchmesser 3,5 mm

VE = 100 Stück

557.045

Vis M4x20

acier zingué, empreinte SR1,
autotaraudeuse, pour ferrures
du cadre ouvrant

Diamètre de perçage 3,5 mm

UV = 100 pièces

557.045

Screw M4x20

galvanised steel, SR1 head,
self-tapping, for fittings on
leaf frame

Hole diameter 3.5 mm

PU = 100 pieces



557.046

Schraube M4x12

Stahl verzinkt, SR1-Angriff,
selbstgewindend, für Eck-
und Scherenlager

Bohrdurchmesser 3,5 mm

VE = 100 Stück

557.046

Vis M4x12

acier zingué, empreinte SR1,
autotaraudeuse, pour charnière
supérieure du compas et
charnière inférieure d'angle

Diamètre de perçage 3,5 mm

UV = 100 pièces

557.046

Screw M4x12

galvanised steel, SR1 head,
self-tapping, for scissor stay
and corner hinges,

Hole diameter 3.5 mm

PU = 100 pieces



557.050

Beschlagsunterlagen

VE = 10 Stück

557.050

Cale

UV = 10 pièces

557.050

Mechanism support

PU = 10 pieces

Schraubenbedarf

Ungefähre Anzahl Schrauben
pro Flügel:

557.045 ca. 120 Schrauben

557.046 ca. 10 Schrauben

Besoins en vis

Nombre approximatif de vis par
vantail:

557.045 env. 120 vis

557.046 env. 10 vis

Screws required

Approximate number of screws
per vent:

557.045 approx. 120 screws

557.046 approx. 10 screws

Beschlagsunterlagen

557.050 ca. 30 Stück

Cale

557.050 env. 30 pièces

Mechanism support

557.050 approx. 30 pieces

5. Fenstergriffe auswählen

5. Choisir la poignée

5. Select handle



557.201
Fenstergriff Aluminium (silber) abschliessbar
mit Vierkantdorn 7 mm, inkl.
2 Befestigungsschrauben M5x30

Höhe: ca. 140 mm
Tiefe: ca. 50 mm

VE = 1 Stück

557.201
Poignée en aluminium (argenté) fermant à clé
avec tige carrée 7 mm, 2 vis
de fixation M5x30 incluses

Hauteur: env. 140 mm
Profondeur: env. 50 mm

UV = 1 pièce

557.201
Handle, aluminium (silver) lockable
with square spindle 7 mm, incl.
2 fixing screws M5x30

Height: approx. 140 mm
Depth: approx. 50 mm

PU = 1 piece



557.210 silber
557.211 weiss
Abdeckkappen oben
für Abdeckung der Scheren-
lager, Scherenbänder,
Drehbänder und Kippbänder

VE = 20 Scherenbandkappen
20 Scherenlagerkappen

557.210 argenté
557.211 blanc
Capuchon haut
pour couvrir les charnières
supérieures du ciseaux,
charnières-compas, charnières
à la française et charnières
à soufflet

UV = 20 capuchons pour
charnières
20 capuchons pour
pivots

557.210 silver
557.211 white
Cover caps top
for covering the scissor stay,
scissor hinge, side-hung hinges
and bottom-hung hinges

PU = 20 cover caps
for scissor hinges
20 cover caps
for scissor stays



557.212 silber DIN links
557.213 weiss DIN links
557.214 silber DIN rechts
557.215 weiss DIN rechts
Abdeckkappen unten
für Abdeckung der Flügellager
und Ecklager

VE = 20 Flügellagerkappen
20 Ecklagerkappen

557.212 argenté DIN gauche
557.213 blanc DIN gauche
557.214 argenté DIN droite
557.215 blanc DIN droite
Capuchon bas
pour couvrir les fiches d'angle
du vantail et charnières
inférieures d'angle

UV = 20 capuchons pour fiches
d'angle du vantail
20 capuchons pour
charnières inférieures
d'angle

557.212 silver DIN left
557.213 white DIN left
557.214 silver DIN right
557.215 white DIN right
Cover caps bottom
for covering leaf hinges and
corner hinges

PU = 20 cover caps for leaf
hinges
20 cover caps for corner
hinges



599.400
Anschlagplatte
Stahl, Silberlook-Oberfläche,
Einsatz als Kippsperre für
Drehflügel

VE = 1 Stück

599.400
Plaque butée
acier, surface argentée, utilisée
comme blocage de position
soufflet pour fenêtre à la
française

UV = 1 pièce

599.400
Stop plate
steel, silver-look surface finish,
use as tilt lock for side-hung
window

PU = 1 piece

6. Bohrlehren auswählen

6. Choisir des outils d'usinage

6. Select drilling jigs



499.450
Bohrlehre Flügel
für die Getriebeausnehmung

VE = 1 Garnitur

499.450
Gabarit de perçage vantail
pour l'évidement du mécanisme

UV = 1 garniture

499.450
Drilling jig for vent
for the cut-out on the
mechanism case

PU = 1 set



499.451
Bohrlehre Flügel
für Getriebebeschieben

VE = 2 Stück

499.451
Gabarit de perçage vantail
pour crémonne de tringle

UV = 2 pièces

499.451
Drilling jig for vent
for mechanism rod

PU = 2 pieces



499.453
Bohrlehre Flügel
für Mittenverriegelungen

VE = 2 Stück

499.453
Gabarit de perçage vantail
pour verrouillages central

UV = 2 pièces

499.453
Drilling jig for vent
for central locks

PU = 2 pieces

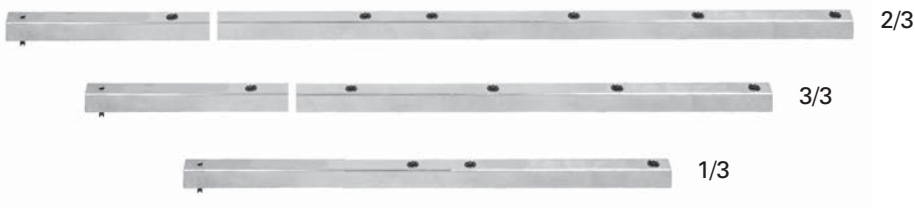

499.454
Bohrlehre Flügel
für Oberschieben

VE = 3 Stück

499.454
Gabarit de perçage vantail
pour tringle supérieure

UV = 3 pièces

499.454
Drilling jig for vent
for top rod

PU = 3 pieces

Verarbeitungshilfen**Outils d'usinage****Assembly tools**

Economy 50 Fenster einbruchhemmend

Fenêtres Economy 50 anti-effraction

Economy 50 windows burglar resistant

**499.455****Bohrlehre Rahmen**
für Eck- und Scherenlager
sowie Kippband

VE = 1 Garnitur

499.455**Gabarit de perçage cadre**
pour charnière inférieure d'angle,
charnière supérieure du ciseaux
et paumelle soufflet

UV = 1 garniture

499.455**Drilling jig for frame**
for corner hinge, scissor
hinge and tilt hinge

PU = 1 set

**499.456****Bohrlehre Flügel**
für Eckumlenkung und
Flügelager

VE = 1 Stück

499.456**Gabarit de perçage vantail**
pour fiche d'angle du vantail
et renvoi d'angle

UV = 1 pièce

499.456**Drilling jig for vent**
for leaf hinge and
corner guides

PU = 1 piece

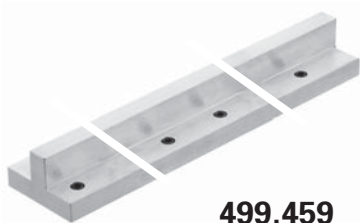
**499.459****Bohrlehre Rahmen**
für Schliessblech und
Kippschliessblech

VE = 1 Stück

499.459**Gabarit de perçage cadre**
pour gâche du rouleau et
gâche oscillo-battant

UV = 1 pièce

499.459**Drilling jig frame**
for strike plate and
tilt striking plate

PU = 1 piece

Verarbeitungshilfen

Outils d'usinage

Assembly tools

Economy 50 Fenster einbruchhemmend

Fenêtres Economy 50 anti-effraction

Economy 50 windows burglar resistant



499.001

Befestigungsset

zum Versetzen der
magazinierten Befestigungs-
Knöpfe 450.007/008

VE = 1 Set komplett inkl. Koffer
3 Kreuzschlitz-
Schraubklingen

499.001

Machine à poser les boutons de parclozes

pour le déplacement des
boutons de fixations 450.007/008
emmagasinés

UV = 1 set complet, valise incl.
3 mèches cruciforme

499.001

Fastening set

for placing magazine fixing
studs 450.007/008

PU = 1 set complete, incl. case
3 Phillips screwdriver
blades



499.002

Kreuzschlitz-Schraubklingen

für Befestigungsset 499.001

VE = 3 Stück

499.002

Embout de tournevis cruciforme

pour machine à poser 499.001

UV = 3 pièces

499.002

Blades for cross-recessed screws (Phillips)

for fastening set 499.001

PU = 3 pieces



499.004

Spiralbohrer ø 3,5 mm

mit Sechskantschaft zum Bohren
der Löcher für 450.006

VE = 3 Spiralbohrer
1 Kupplungsüber-
brückung für Set 499.001

499.004

Mèche hélicoïdale ø 3,5 mm

avec serrage 6-pans pour percer
les trous de 450.006

UV = 3 mèches hélicoïdales
1 système d'embrayage
pour set 499.001

499.004

Twist drill ø 3,5 mm

with hexagonal shaft, for drilling
holes for 450.006

PU = 3 twist drills
1 coupling bridge for
Set 499.001



499.039

Bohrer-Führung ø 3,5 mm

für Befestigungsset 499.001,
optimiert die Führung des
Spiralbohrers 499.004 und
ermöglicht ein genaues Bohren.

VE = 1 Stück

499.039

Guidage de foret ø 3,5 mm

pour la machine à poser les bou-
tons 499.001, optimise le guidage
de la mèche hélicoïdale 499.004
et permet un perçage précis.

UV = 1 pièce

499.039

Drill guide ø 3,5 mm

for fastening set 499.001,
optimises the guidance of the
twist drill 499.004, and permits
precise drilling.

PU = 1 piece



499.003

Schraubklingen

mit SR1-Angriff,
für Akku-Schrauber

VE = 3 Stück

499.003

Embout de tournevis

avec tête spéciale SR1,
pour visseuse à accumulateur

UV = 3 pièces

499.003

Blades

with SR1 head,
for battery-operated screw driver

PU = 3 pieces

Beschlageinbau

Beschlageinbau-Zeichnungen für den Standard-Fensterbeschlag siehe «Jansen-Economy 50 Fenster – Beschlageinbau und Montage»

Online-Zugriff

extranet.jansen.com/bestellkatalog

Über diesen Link haben Sie direkten Zugriff auf die einzelnen Kapitel des Bestellkatalogs in Form von PDFs und können die darin verlinkten detaillierten CAD-Zeichnungen (DWG- und DXF-Dateien) gratis downloaden.

Voraussetzung ist Ihre Registrierung im Jansen Extranet.

Montage des ferrures

Dessins de montage des ferrures standard pour fenêtre voir «Fenêtres Jansen-Economy 50 – Montage des ferrures et usinage»

Accès en ligne

extranet.jansen.com/catalogue

Ce lien vous donne un accès direct aux différents chapitres du catalogue de commande au format PDF et vous permet de télécharger gratuitement les dessins DAO (fichiers DWG et DXF) détaillés mis en lien qu'il contient.

Vous devez pour cela être enregistré dans l'Extranet Jansen.

Installation of fittings

Drawings for installation of fittings of the standard window fitting see «Jansen-Economy 50 windows – Installation of fittings and assembly»

Online access

extranet.jansen.com/ordercatalogue

Via this link, you can enjoy direct access to the individual chapters of the order manual in the form of PDFs and download the detailed CAD drawings linked to them (DWG and DXF files) free of charge.

To do so, you are required to register for the Jansen Extranet.

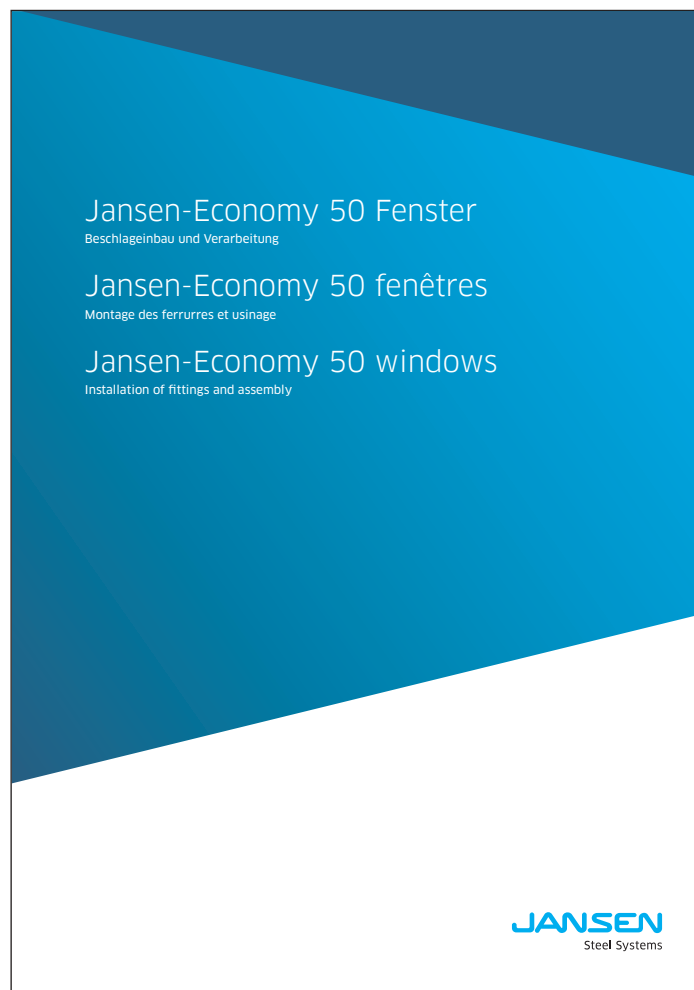

Legende Dreh- und
 Drehkippschlag Standard

Légende ferrure oscillo-battante
 et à la française Standard

Key to Standard tilt-turn and
 side-hung fitting

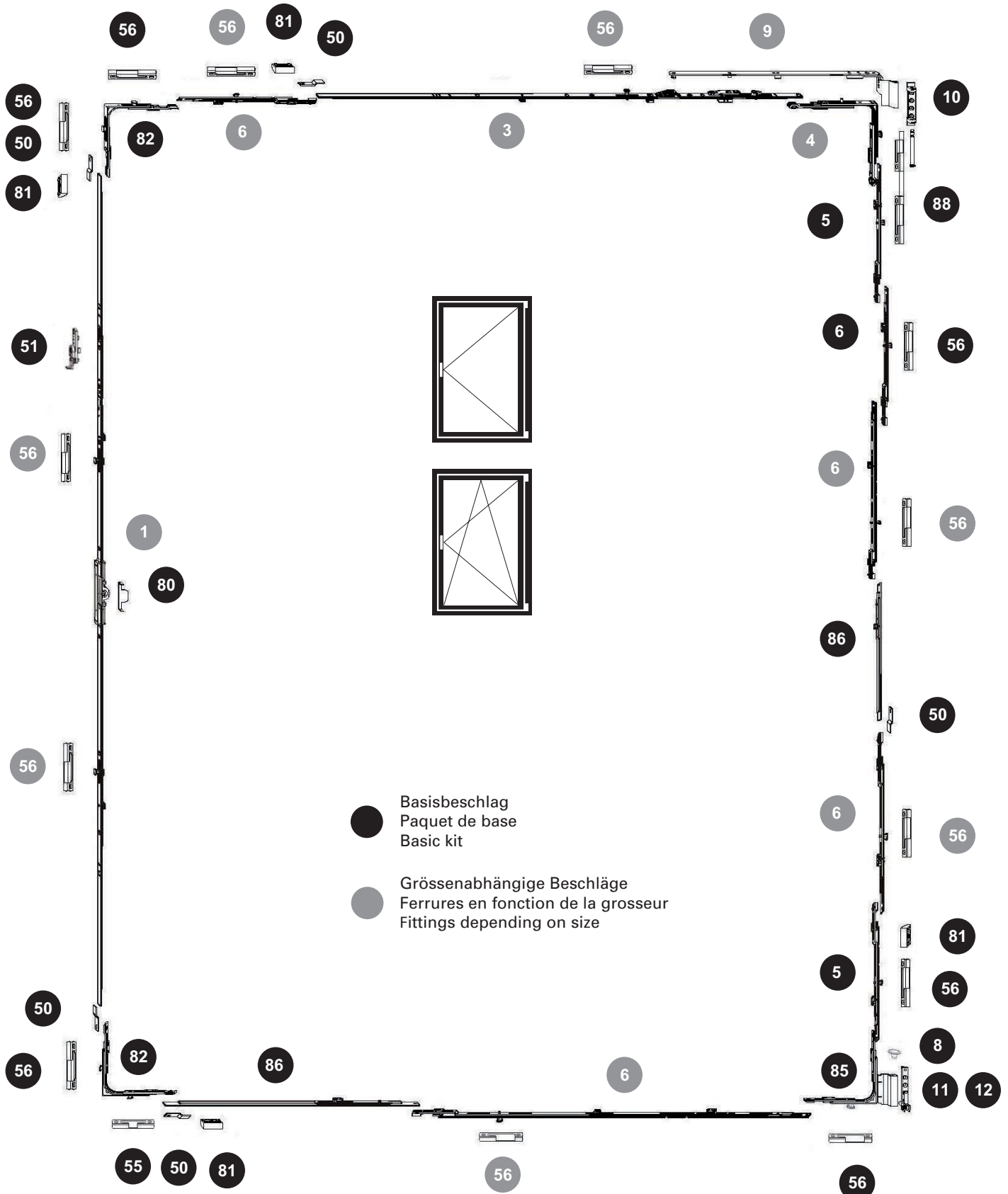

Beschlageinbau
Montage des ferrures
Installation of fittings

Economy 50 Fenster einbruchhemmend
Fenêtres Economy 50 anti-effraction
Economy 50 windows burglar resistant

Pos.	Beschrieb Description Description	Kennzeichnung Désignation Designation	Einsatz Utilisable Suitable	Bohrlehre Gabarit de perçage Drilling jig	Artikel-Nr No d'article Part no.
1	Getriebebeschiene Crémone de triangle Mechanism rod	GAK.830-1.D.7,5 GAM.1400-2.D.7,5 GAM.1800-2.D.7,5	FFH 830 - 900 FFH 901 - 1800 FFH 1801 - 2300	499.451 G.F G.C G.D	599.489 599.490 599.410
3	Oberschiene Tringle supérieure Top rod	OS1.600 OS2.1025-1	FFB 630 - 775 FFB 776 - 1475	499.454 O.A O.C	599.434 599.436
4	EckmLenkung Renvoi d'angle Corner guide	E2 E3		499.456 E	599.403 599.404
5	Mittenverriegelung Verrouillage central Central lock	MK.PA.250-1		499.453 M.B	599.417
6	Mittenverriegelung Verrouillage central Central lock	MK.250-1 MK.500-1 MK.750-1		499.453 M.A M.C M.D	599.413 599.415 599.416
8	Flügelagerstopfen Bouchon Vent bearing stoppers	FWV SL			599.433
9	Schere Compas Stay	SK.1.18-9.RS SK.1.18-9.RS SK.2.18-9.LS SK.2.18-9.RS	links/à gauche/left rechts/à droite/right links/à gauche/left rechts/à droite/right		599.439 599.440 599.441 599.442
10	Scherenlager Charnière supérieure du ciseaux Scissor hinge part	SL.K.3-6.130		499.455 E	599.443
11	Ecklager Charnière inférieure d'angle Corner hinge part	ESV 6-3-16 SL		499.455 E	599.428
12	Unterlage Ecklager (nicht notwendig) Cale charnière d'angle (pas nécessaire) Support for corner pivot (not necessary)				599.533
50	Stulpplatte Plaque Connecting piece	ER J SL			599.425
51	Fehlschaltssicherung Anti-fausse manoeuvre Fool-proof mechanism	FSA			599.406
55	Kippschliessblech Gâche oscillo-battante Tilt striking plate	SBK.S.9-18.J		499.459 S.A	599.484
56	Sicherheitsschliessblech Gâche de sécurité Security strike plate	SBS.S.9-18.J.LS SBS.S.9-18.J.RS	links/à gauche/left rechts/à droite/right	499.459 S.A	599.482 599.483
60	Schraube / Vis / Screw M4x20				557.045
61	Schraube / Vis / Screw M4x12				557.046
63	Beschlagunterlage / Cale / Mechanism support				557.050
80	Anbohrschutz Anti-Perçage Anti drilling device	G.D.7,5			599.485
81	Auflauf Appui Lock staple	AUFLAUF D WEISS			599.531
82	EckmLenkung Renvoi d'angle Corner guide	E11		499.456 E	599.486
85	EckmLenkung Renvoi d'angle Corner guide	ECKUML.E1.FWSB.18-9-12.LS ECKUML.E1.FWSB.18-9-12.RS	links/à gauche/left rechts/à droite/right	499.456 E	599.487 599.488
86	Koppelement Element de liaison Coupling	KE SL		499.453 M.E	599.491
88	Sicherheitsschliessblech Gâches de sécurité Security strike plate	SBS.S.9-18.J.RC-3.LS SBS.S.9-18.J.RC-3.RS	links/à gauche/left rechts/à droite/right	499.459 S.A	599.534 599.535

Schnittpunkte im Massstab 1:1
Coupe de détails à l'échelle 1:1
Section details on scale 1:1

Economy 50 Fenster einbruchhemmend
Fenêtres Economy 50 anti-effraction
Economy 50 windows burglar resistant

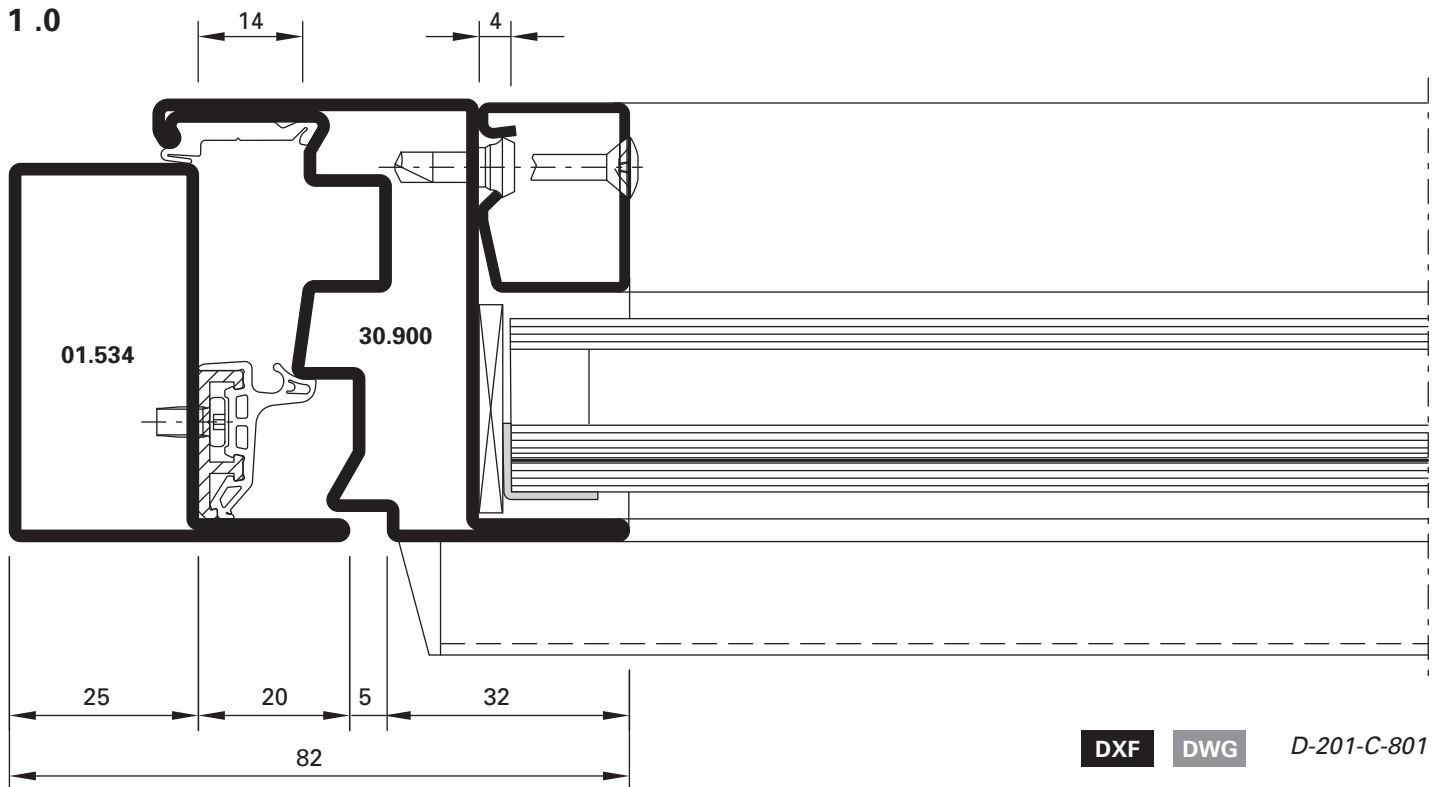
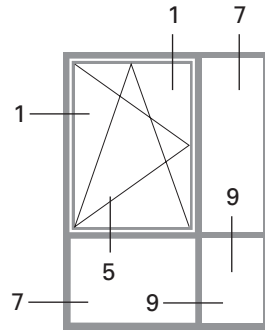
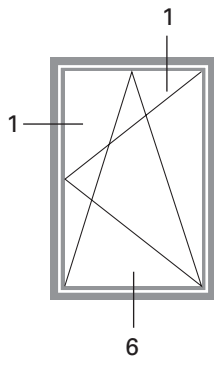
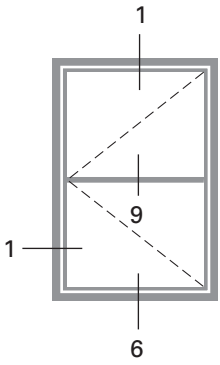

7.0

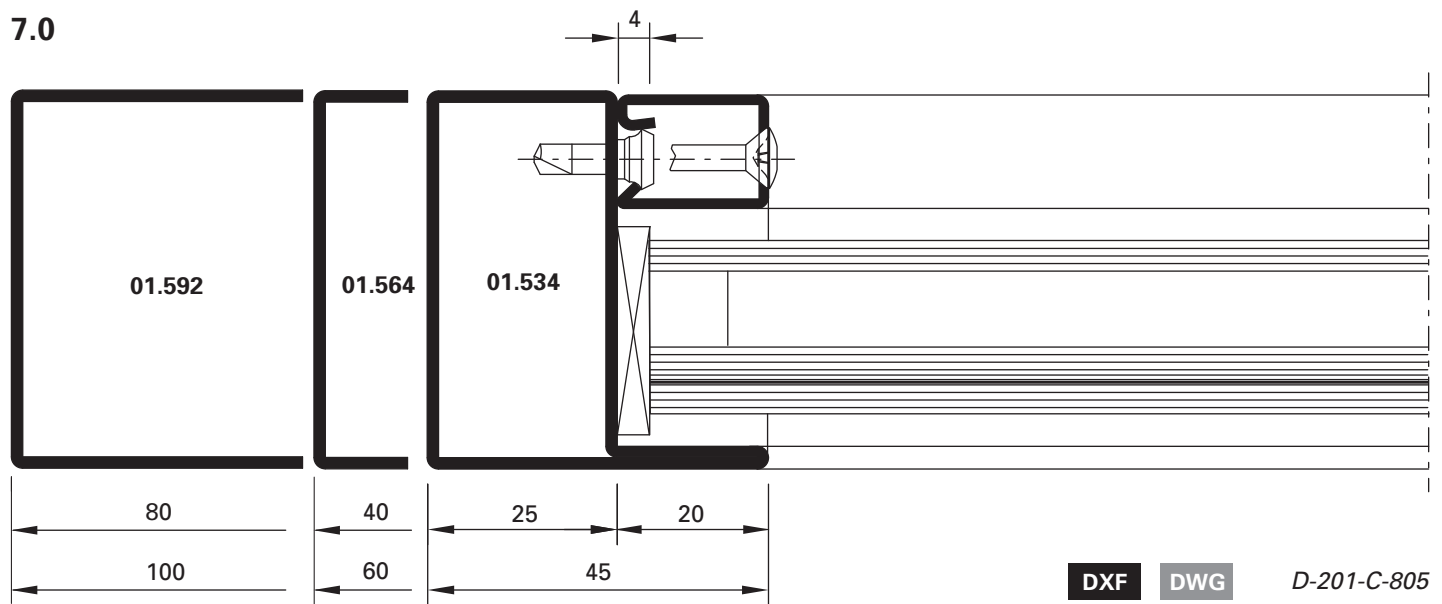

7.1

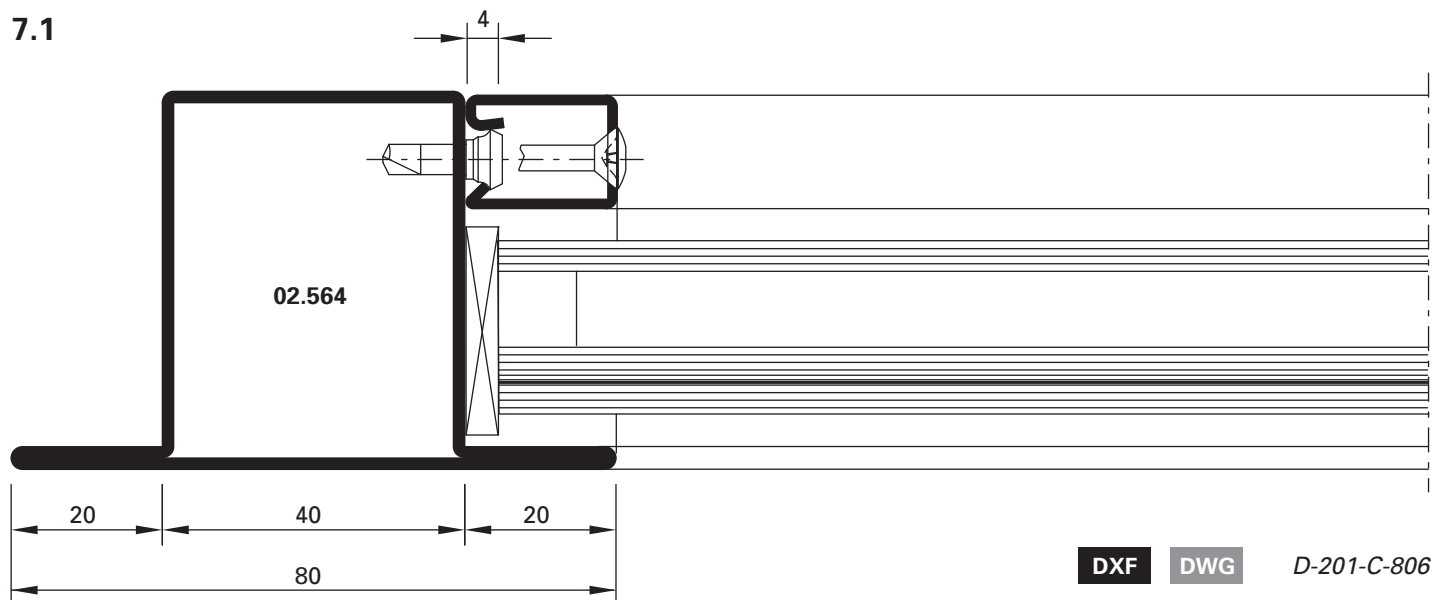

9.0

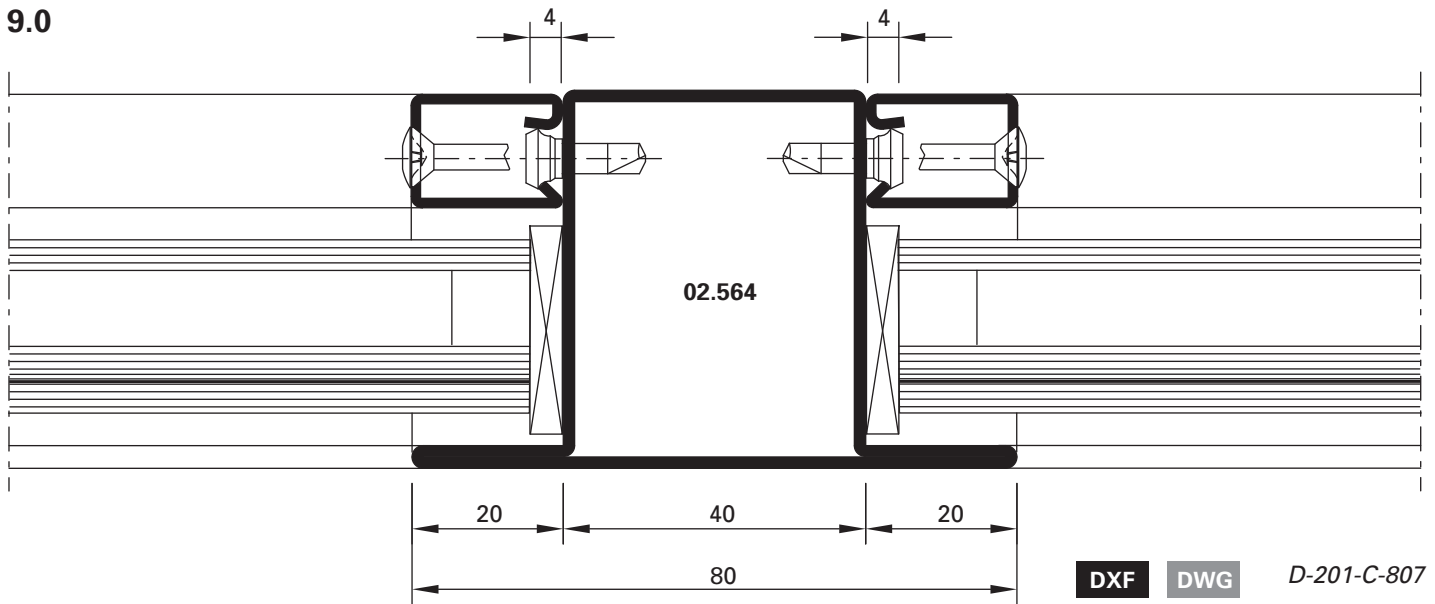

9.1

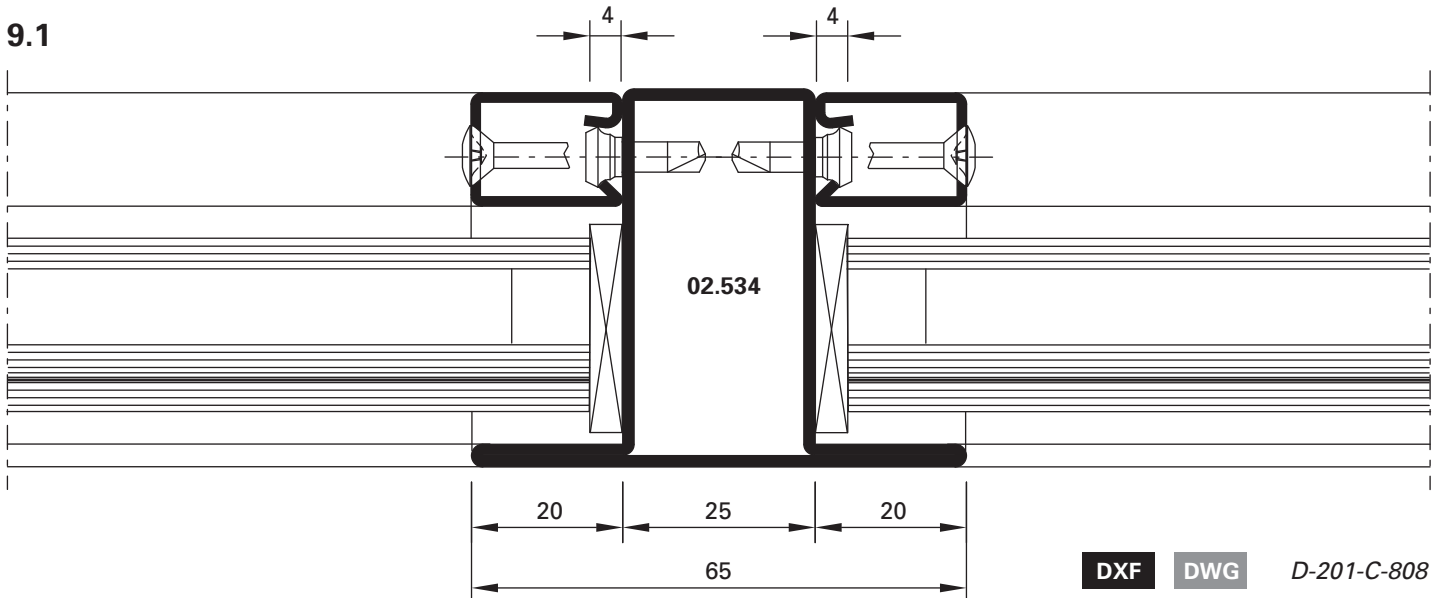

5.0

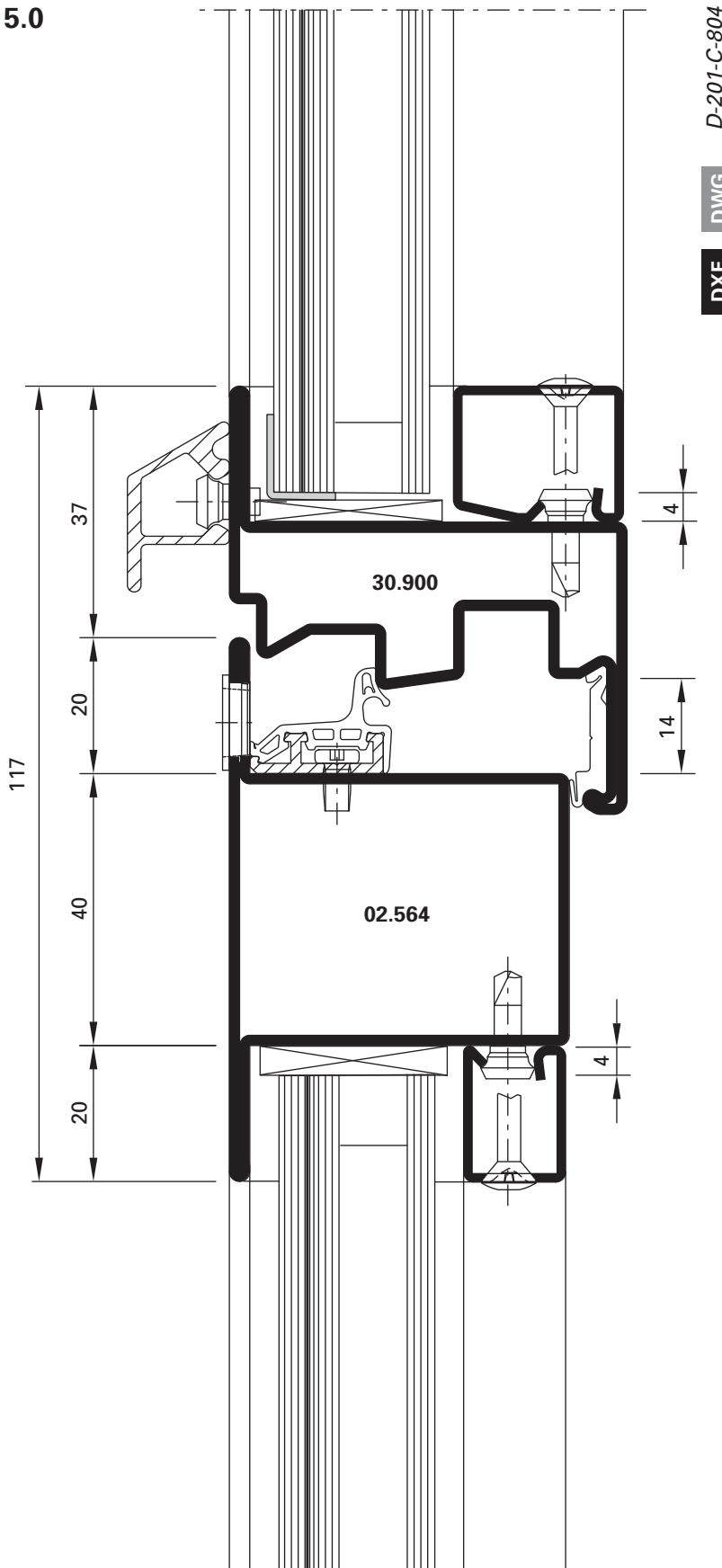

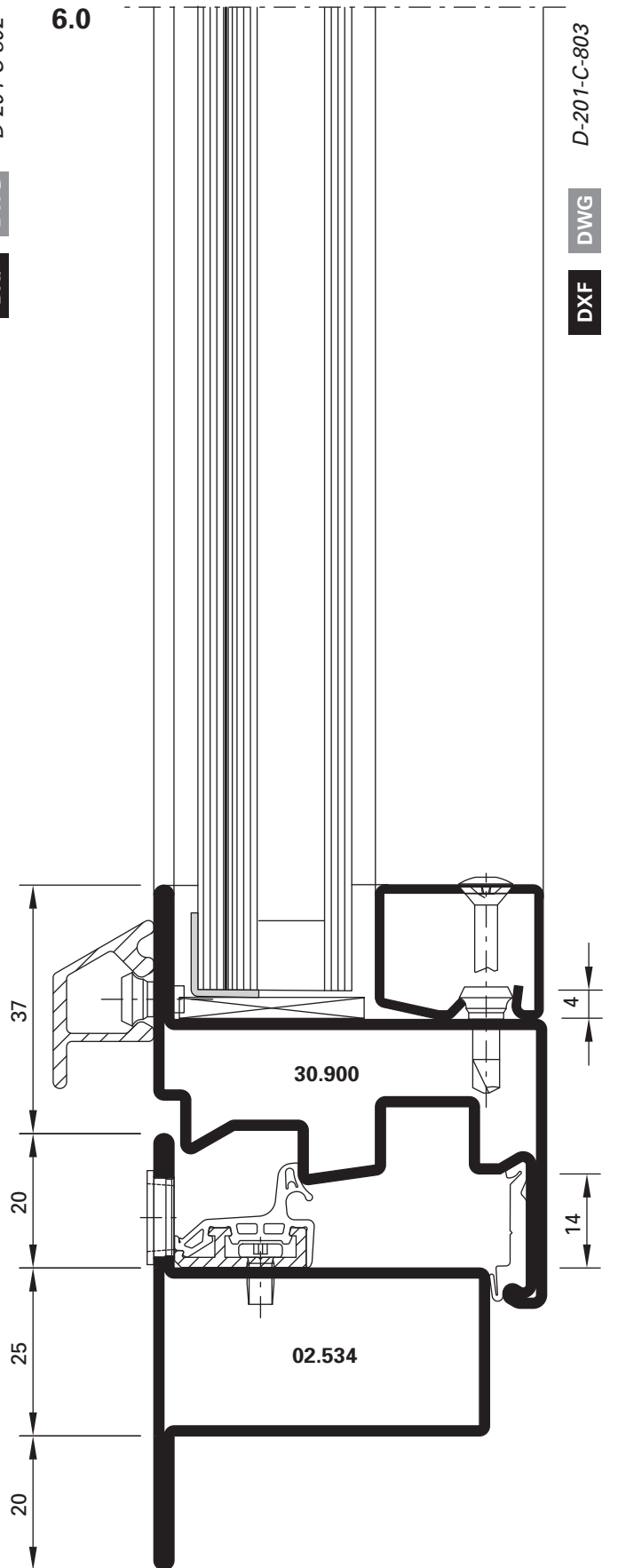
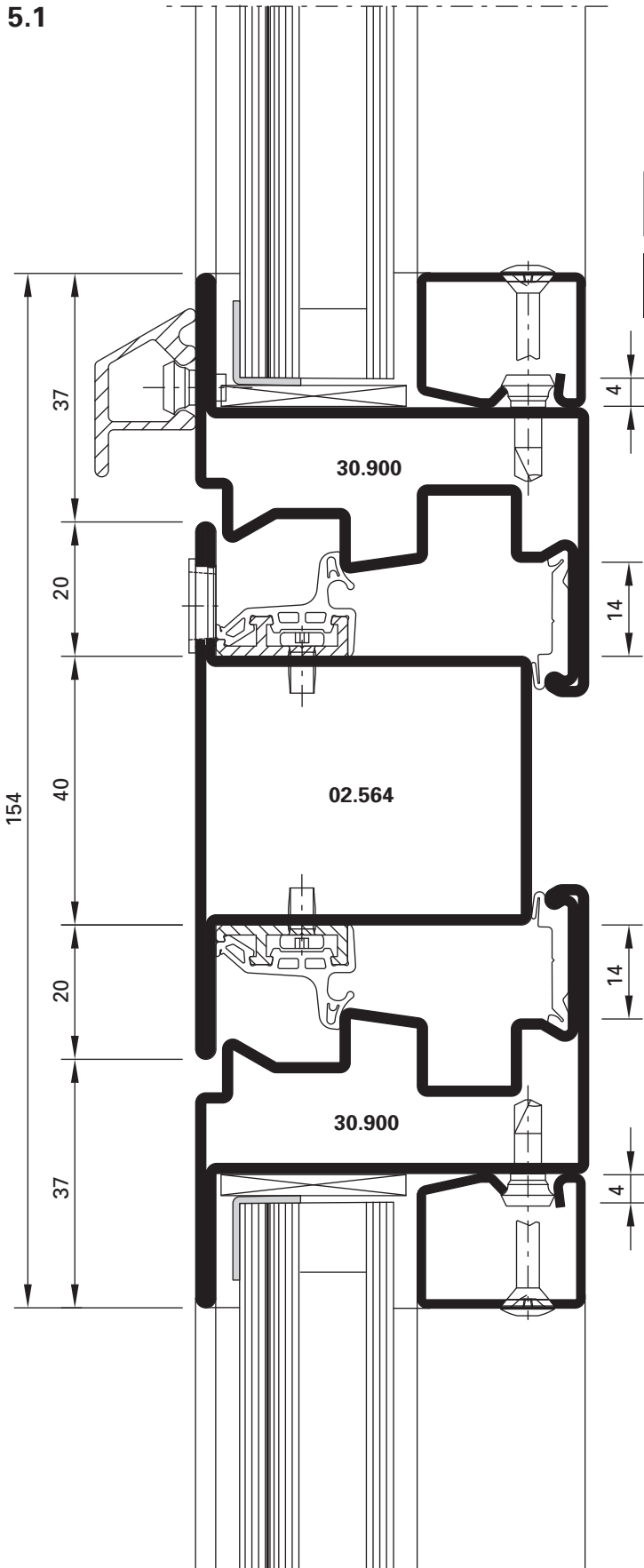

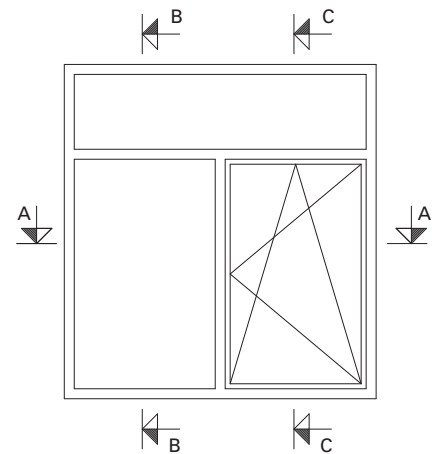
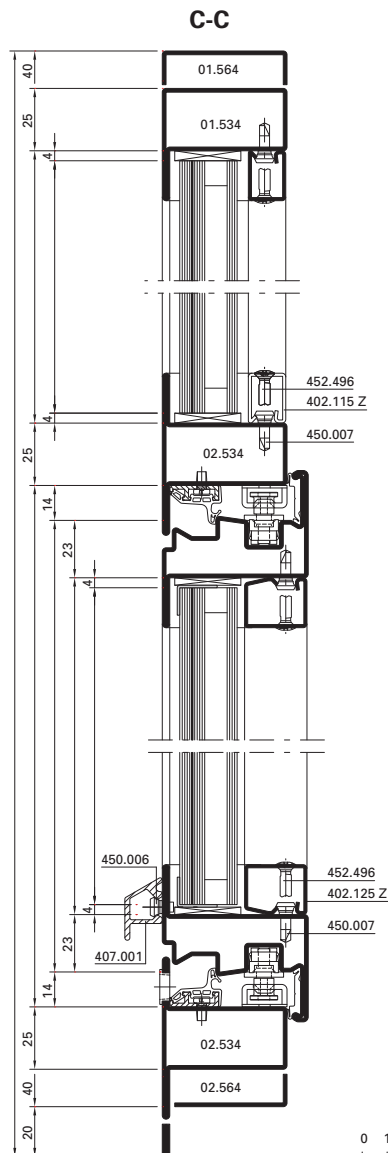
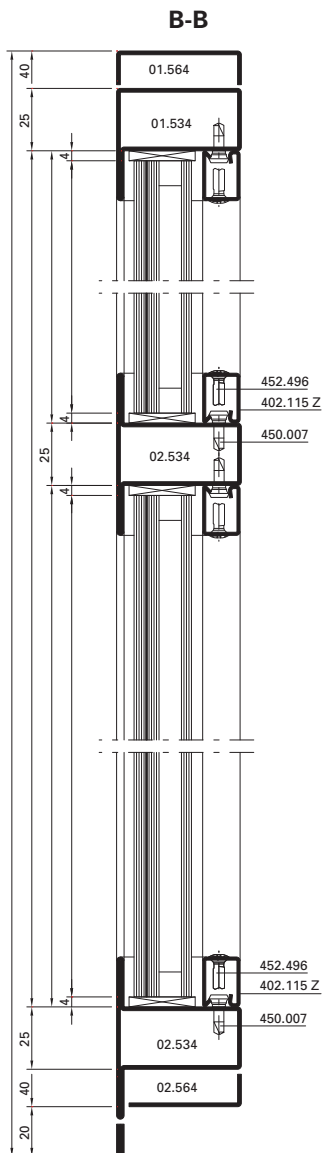
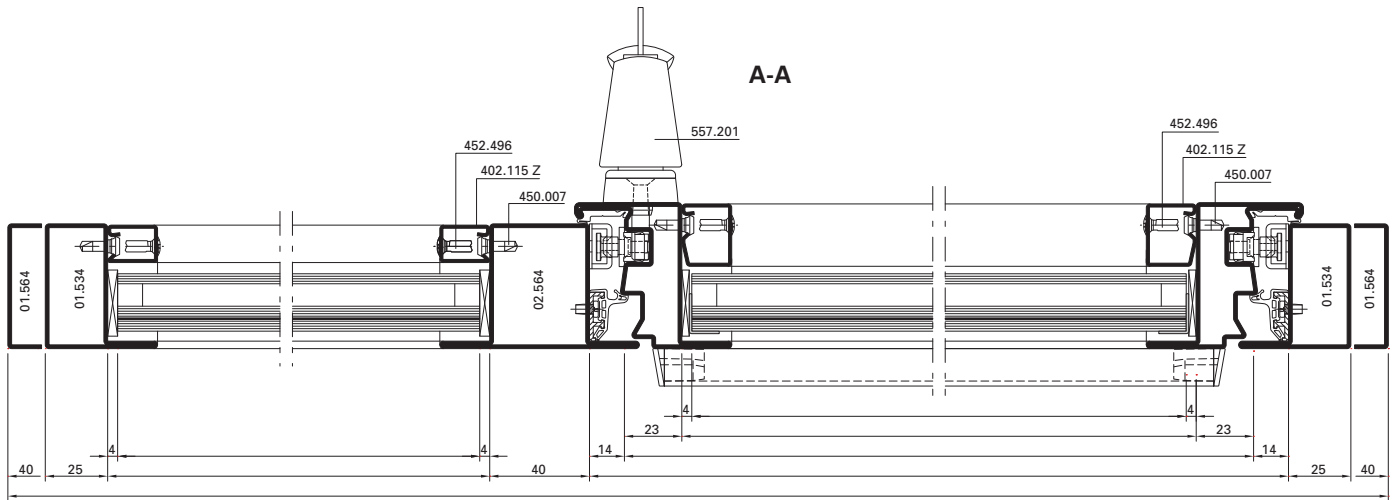

Glasleisten-Varianten im Masstab 1:2

Variantes de parcloles à l'échelle 1:1

Glazing bead options on scale 1:2

Economy 50 Fenster einbruchhemmend

Fenêtres Economy 50 anti-effraction

Economy 50 windows burglar resistant

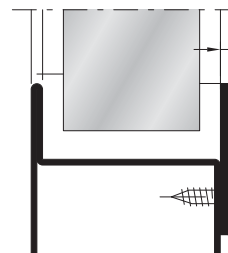
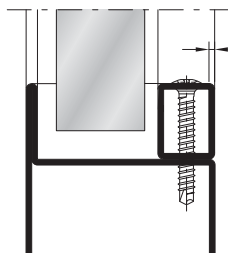
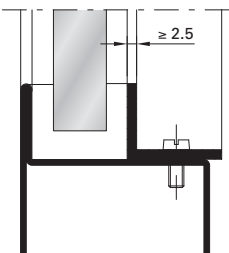
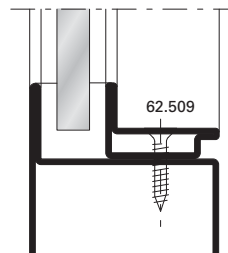
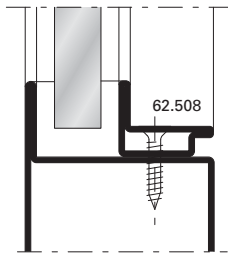
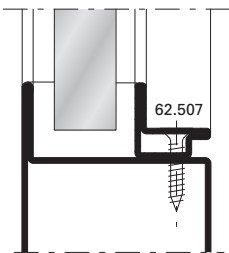
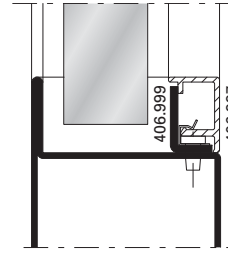
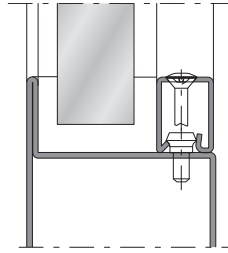
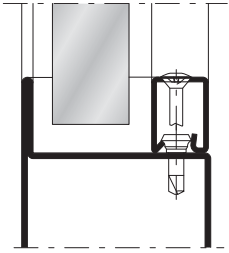

Ausnehmung Getriebeschiene
 599.489, 599.490, 599.410 und
 Aufbohrschutz 599.485

Entaille crénone de tringle
 599.489, 599.490, 599.410 et
 anti-perçage 599.485

Cut-out mechanism rod
 599.489, 599.490, 599.410 and
 anti drilling device 599.485

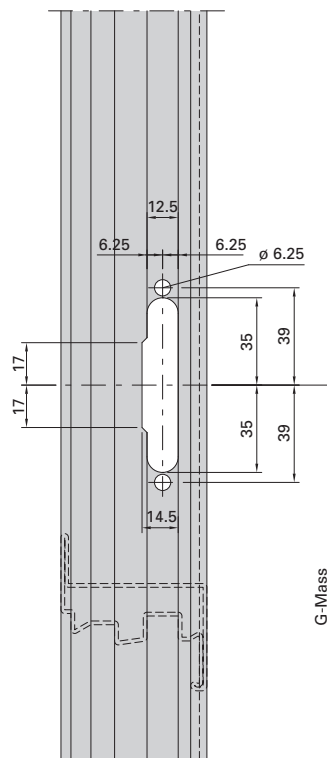
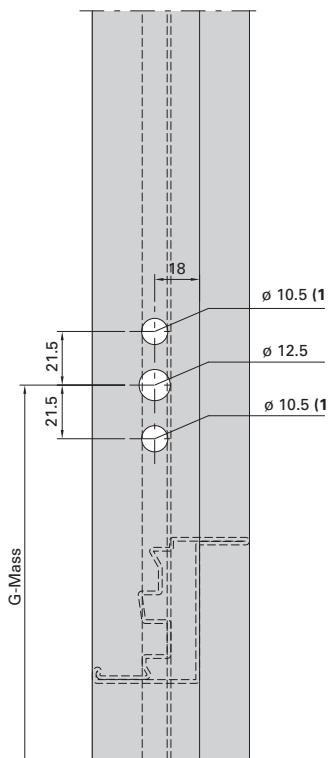
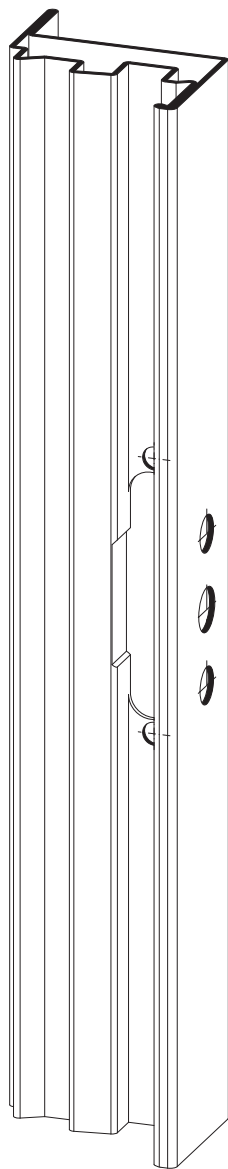

- 1) Bohrung je nach Stütznocken-Durchmesser des Griffes
- 1) Perçage selon le diamètre du plot de la poignée
- 1) The drill hole depends on the diameter of the support leg of the handle

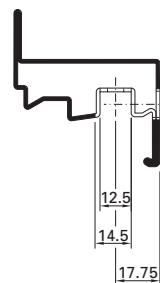
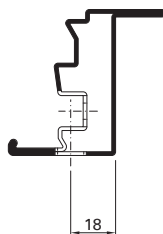

Beschlageinbau

Montage des ferrures

Installation of fittings

Economy 50 Fenster einbruchhemmend

Fenêtres Economy 50 anti-effraction

Economy 50 windows burglar resistant

Position Schliessbleche und Auflauf unten

Position gâches et appui en bas

Bottom position of the strike plates and engagement block

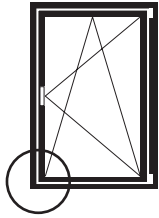

DIN rechts/droite/right

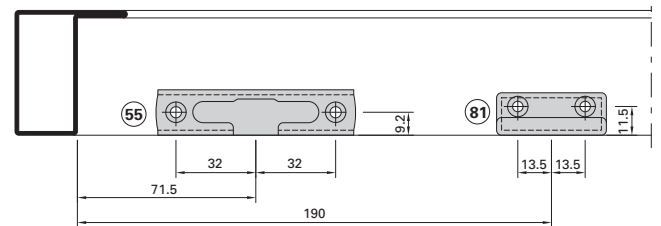
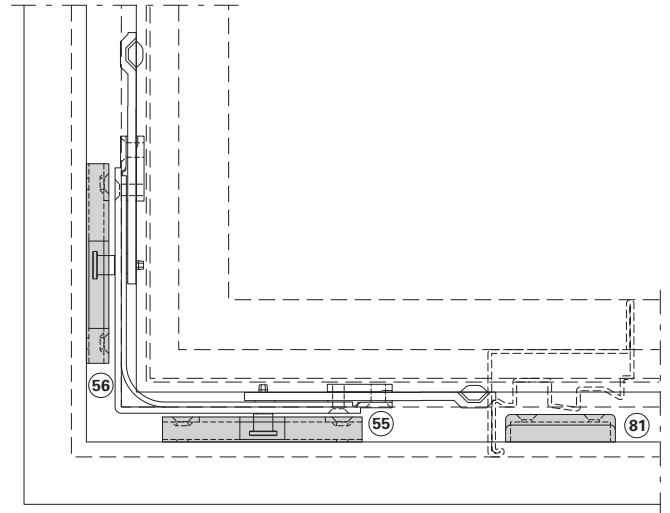
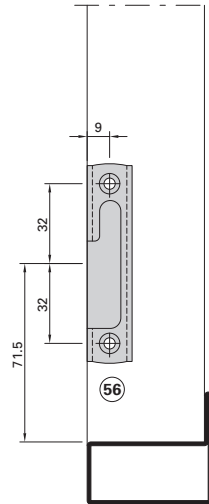

55	Kippschliessblech Gâche oscillo-battante Tilt striking plate	599.484
56	Sicherheitsschliessblech Gâche de sécurité Security strike plate	599.482/599.483
81	Auflauf Appui Lock staple	599.531

Einbau teilweise mit 499.459

Montage partiellement avec 499.459

Partial installation with 499.459

**Position Schliessbleche
 und Auflauf unten**

Position gâches et appui en bas

**Bottom position of the strike plates
 and engagement block**

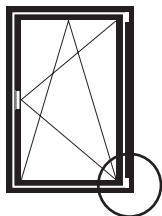

DIN rechts/droite/right

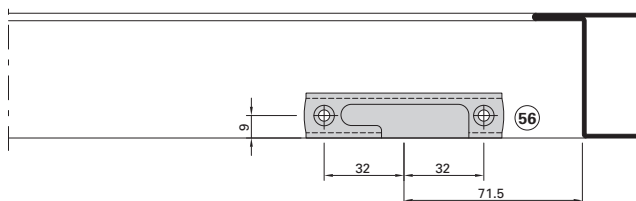
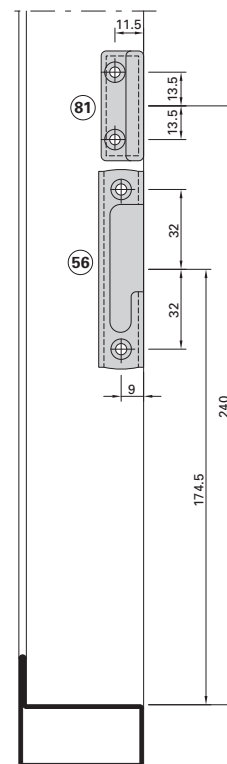
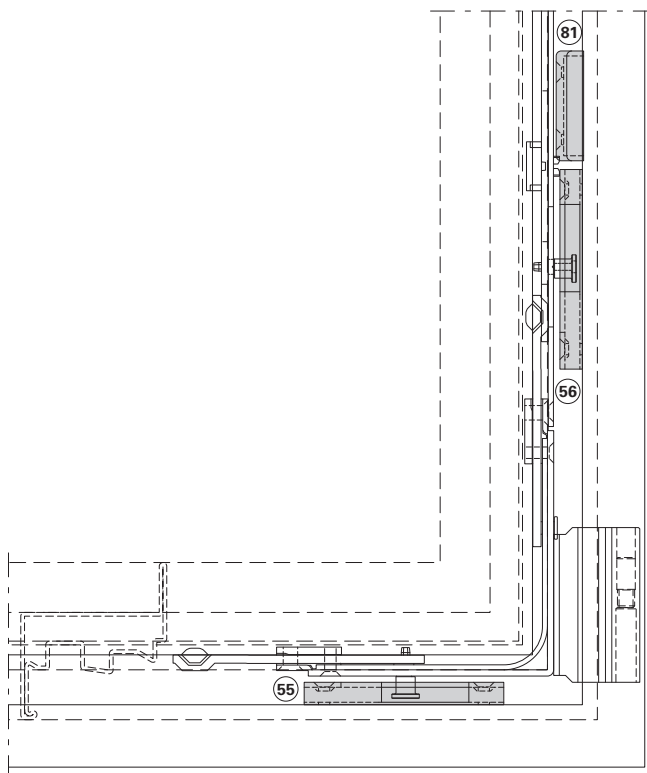

- 56 Sicherheitsschliesblech 599.482/599.483
 Gâche de sécurité
 Security strike plate
- 81 Auflauf 599.531
 Appui
 Lock staple

Position Schliessblech oben

Position gâche en haut

Top position of the strike plate

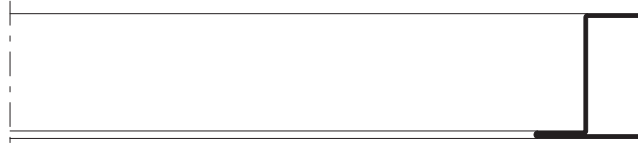
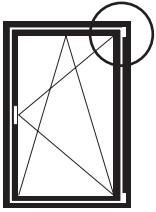

DIN rechts/droite/right

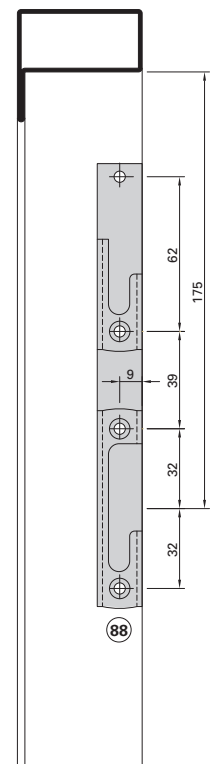
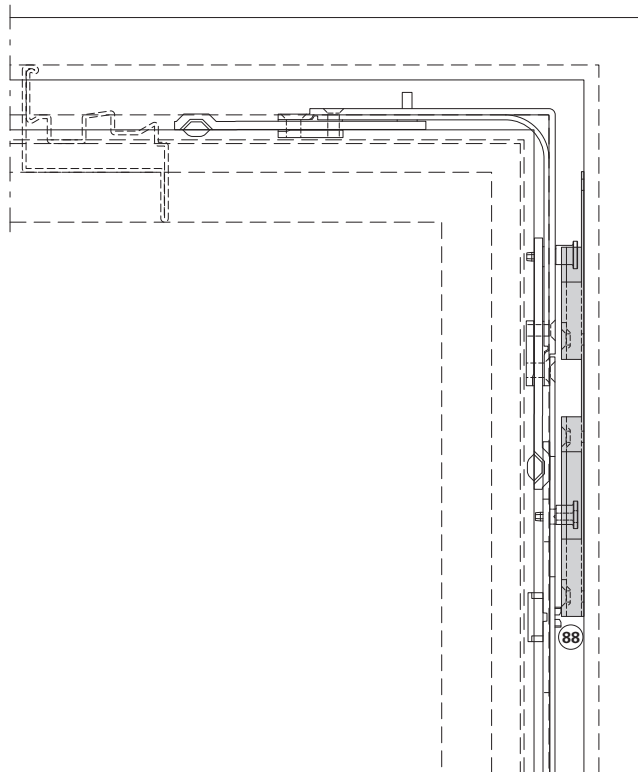

88 Sicherheitsschliessblech 599.534/599.535
 Gâches de sécurité
 Security strike plate

**Position Schliessbleche und
 Auflauf oben**

FFB: 630 - 775 mm
 1026 - 1475 mm

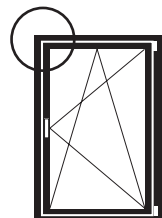

DIN rechts/droite/right

Position gâches et appui en haut

FFB: 630 - 775 mm
 1026 - 1475 mm

**Top position of the strike plates and
 engagement block**

FFB: 630 - 775 mm
 1026 - 1475 mm

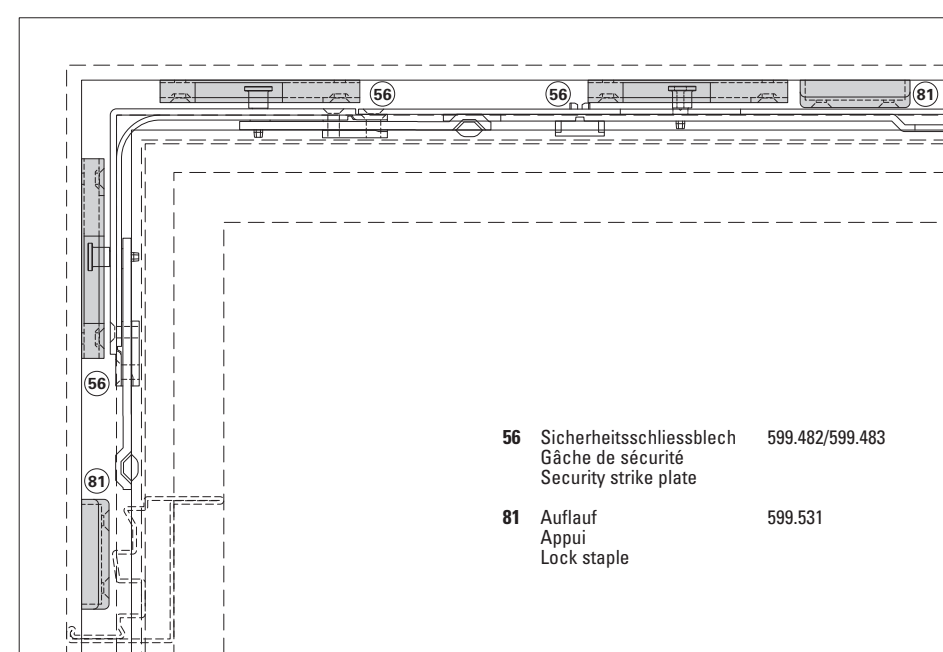
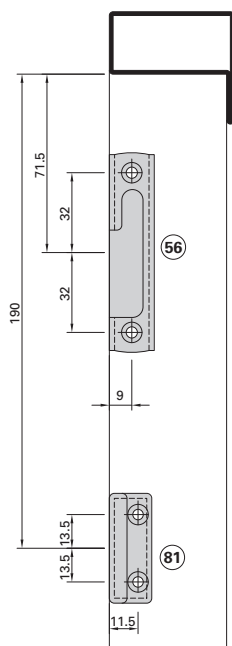
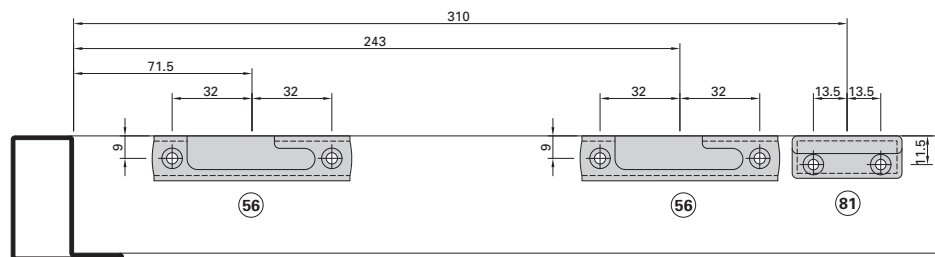

- | | | |
|-----------|--|-----------------|
| 56 | Sicherheitsschliessblech
Gâche de sécurité
Security strike plate | 599.482/599.483 |
| 81 | Auflauf
Appui
Lock staple | 599.531 |

Beschlageinbau
Montage des ferrures
Installation of fittings

Economy 50 Fenster einbruchhemmend
 Fenêtres Economy 50 anti-effraction
 Economy 50 windows burglar resistant

**Position Schliessbleche und
 Auflauf oben**

FFB: 776 - 1025 mm

Position gâches et appui en haut

FFB: 776 - 1025 mm

**Top position of the strike plates and
 engagement block**

FFB: 776 - 1025 mm

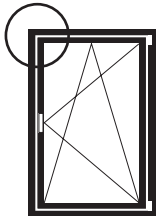

DIN rechts/droite/right

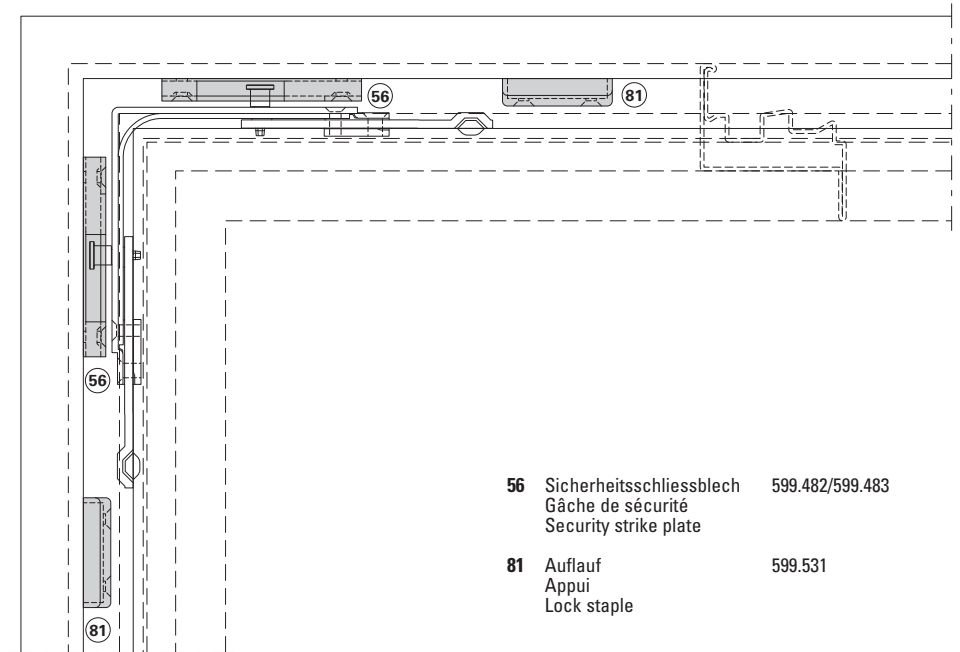
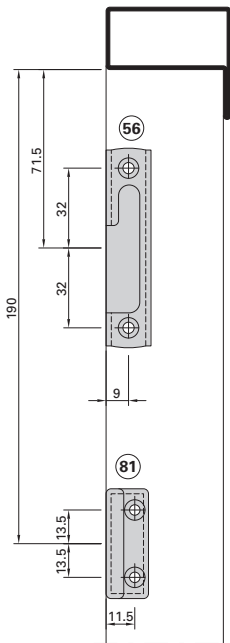
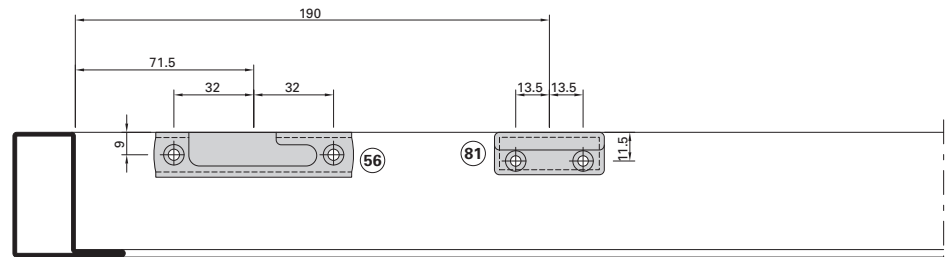

- | | | |
|-----------|--|-----------------|
| 56 | Sicherheitsschliessblech
Gâche de sécurité
Security strike plate | 599.482/599.483 |
| 81 | Auflauf
Appui
Lock staple | 599.531 |

Einbau teilweise mit 499.459

Montage partiellement avec 499.459

Partial installation with 499.459

Glasleisten-Sicherung

Blocage des parclores

Glazing bead fixing

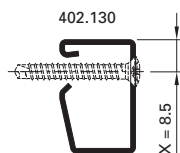
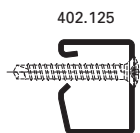
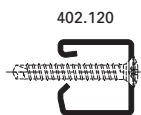
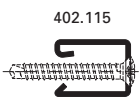
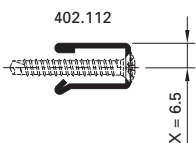
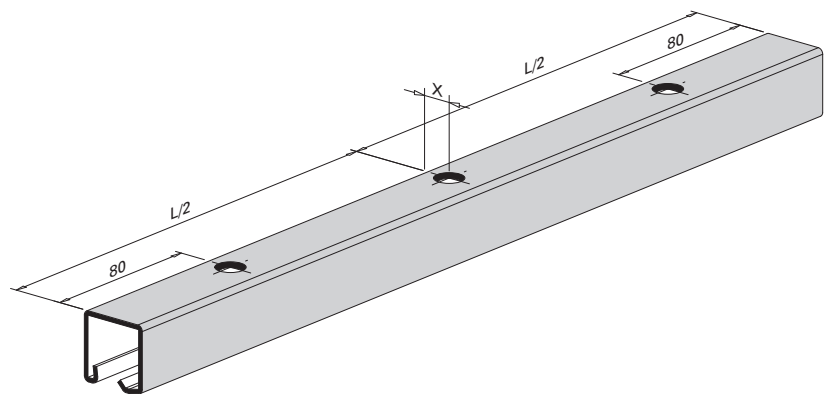
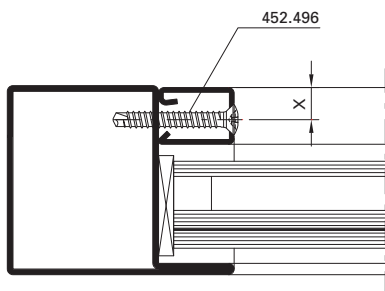
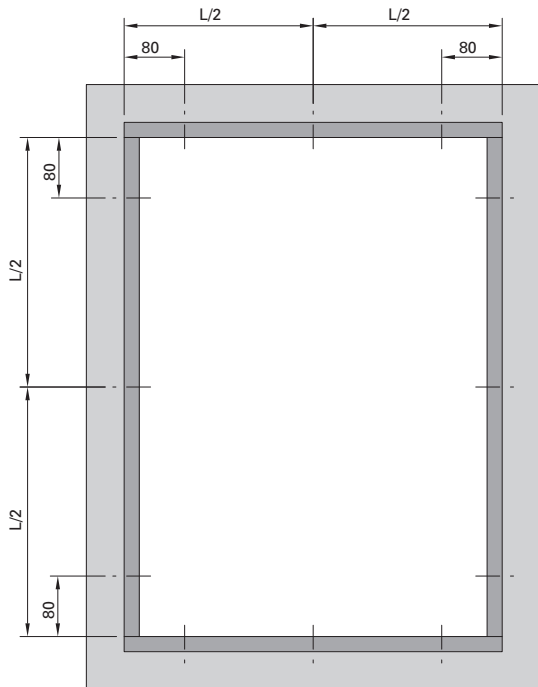

**Montage Edelstahl-Winkel
 Flügelprofile**

**Montage cornière en acier inox
 Profilé de vantail**

**Installation of the
 stainless steel bracket
 Vent profile**

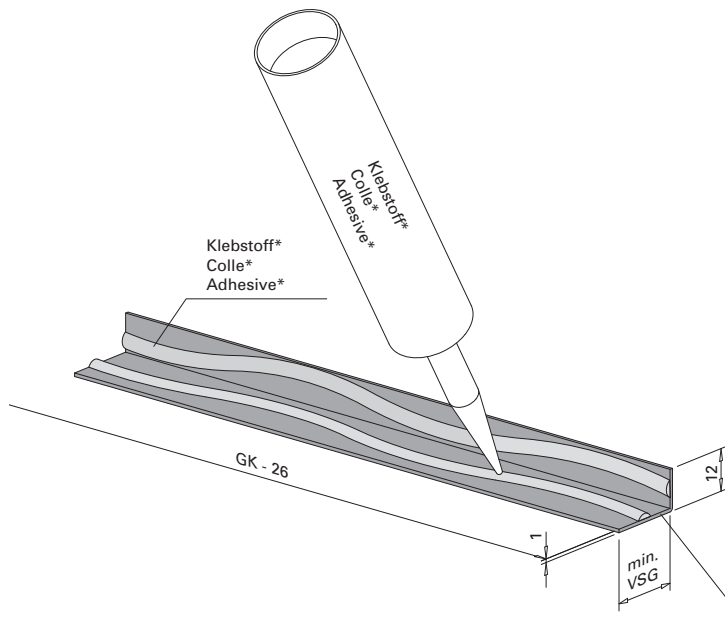

- * Klebstoff mit Glaslieferant abklären
- * S'accorder sur la colle avec le fournisseur de vitrage
- * Clarify adhesive with glass supplier

Edelstahl 1 mm
 (durch Metallbauer zu fertigen)
 Acier Inox 1 mm
 (à fabriquer par le métallier)
 Stainless steel 1 mm
 (to made by metal constructor)

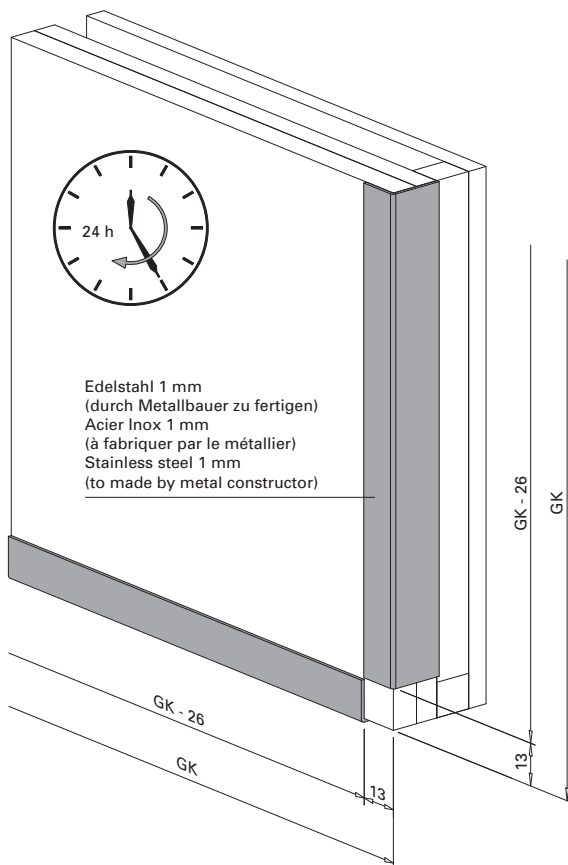

Edelstahl 1 mm
 (durch Metallbauer zu fertigen)
 Acier Inox 1 mm
 (à fabriquer par le métallier)
 Stainless steel 1 mm
 (to made by metal constructor)

Angriffseite
 Côté exposé
 Attack side

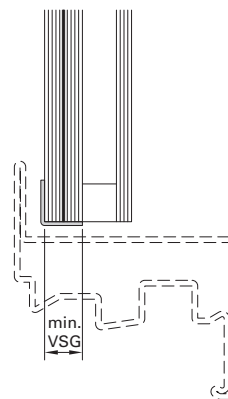

Verklotzen der Fenster

Calage des fenêtres

Glazing blocks of the windows

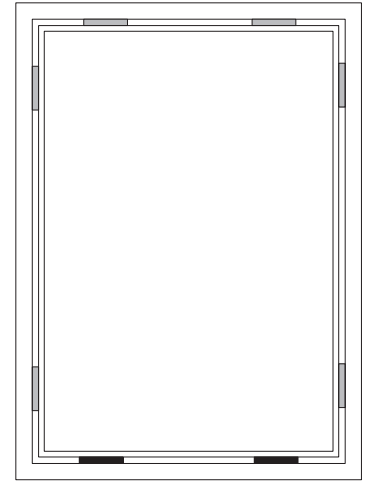
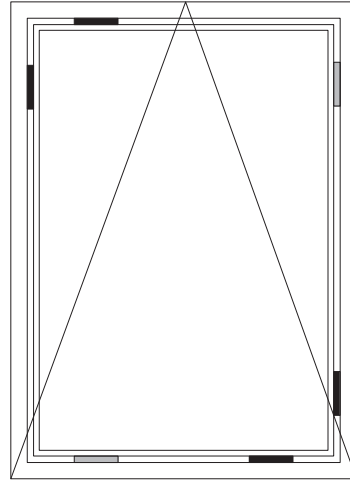
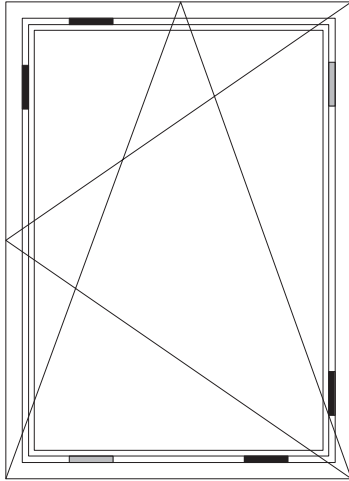

Tragklotz
 Cale d'assise
 Support block



Distanzklotz und zusätzlich bei jedem Verriegelungspunkt
 Cale d'écartement et en plus à chaque point de verrouillage
 Spacer block and additionally for every locking point



Verklotzen der Verriegelungspunkte

Sämtliche Verriegelungspunkte müssen zusätzlich verklebt werden.

Calage des points de verrouillage

Tous les points de verrouillage doivent de plus être collés.

Blocking the locking points

All locking points must be additionally bonded.

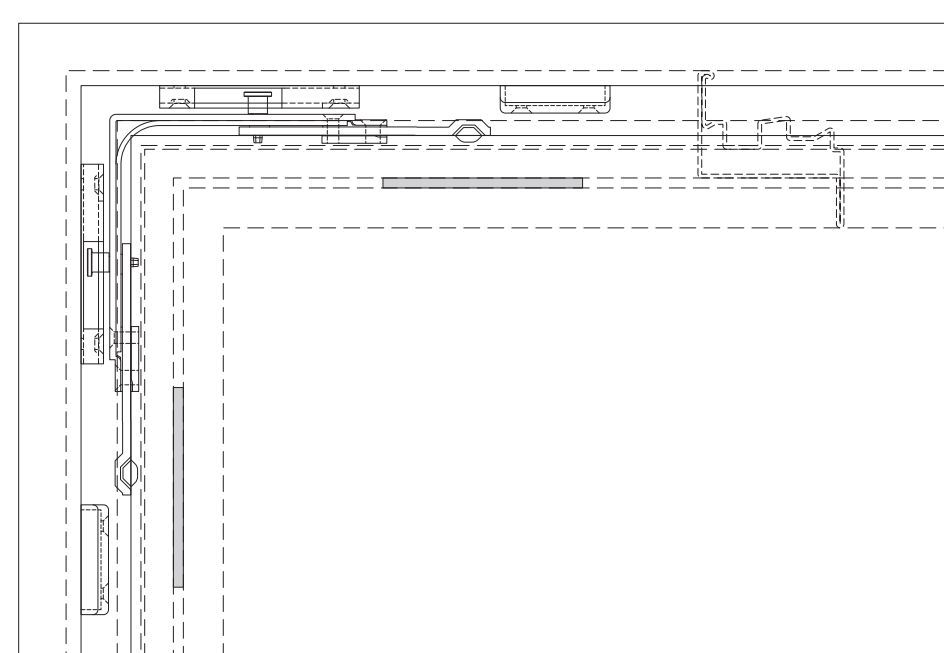

**Glaseinbau mittels
 Nassverglasung**

**Pose des verres avec
 vitrage à mastic**

**Glazing with glazing
 with sealing**

Abstände Glasleisten-Befestigungsknöpfe
 450.007/006

Distance entre boutons de fixation
 450.007/006

Distance between fastening studs
 450.007/006

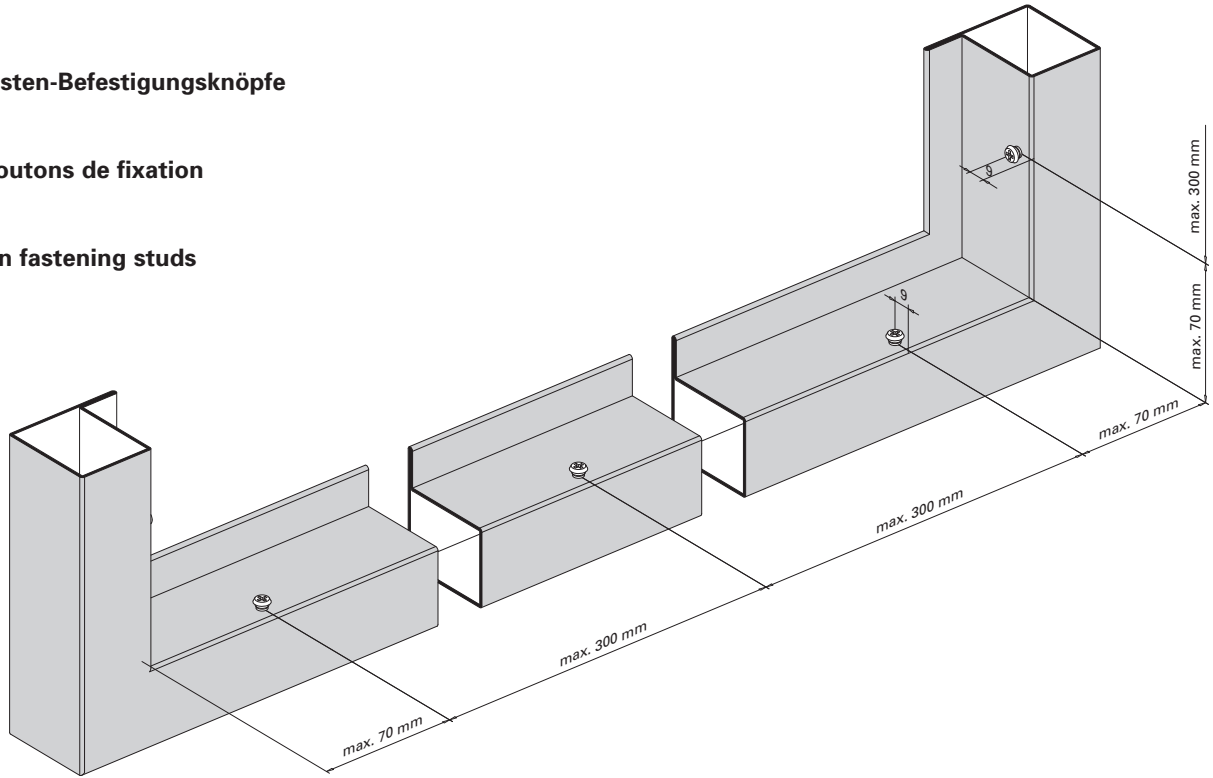

**Bestimmung der Distanzbänder
 und des Falzspiels**

**Détermination des bandes
 d'écartement et les jeu de feuillure**

**Determining packing strips and
 rebate allowance**

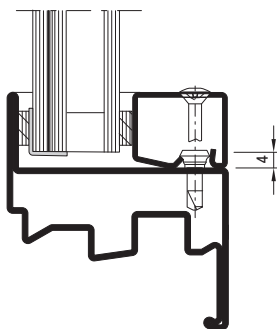
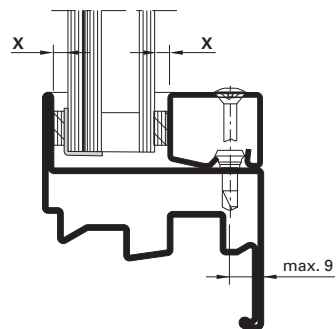
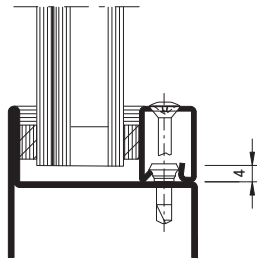
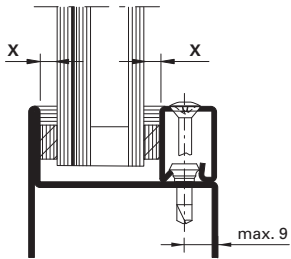

Stahl-Glasleiste
 Parclose en acier
 Steel glazing bead

Falzspiel
 Jeu de feuillure
 Rebate allowance

X:
 Distanzbanddicke =
 Fugenbreite

X + 2:
 Distanzbanddicke =
 Fugenbreite + 2 mm

X:
 Epaisseur de la bande d'écartement =
 Largeur de joint

X + 2:
 Epaisseur de la bande d'écartement =
 Largeur de joint + 2 mm

X:
 Thickness of packing strip =
 Width of joint

X + 2:
 Thickness of packing strip =
 Width of joint + 2 mm

Ablaufschritte Glaseinbau

Procédure pour la pose des vitres

Steps in fitting glass panes

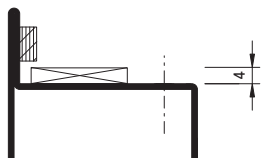

Distanzband auf Profillappen kleben
 Coller la bande d'écartement sur la battue du profilé
 Attach packing strip to section flange

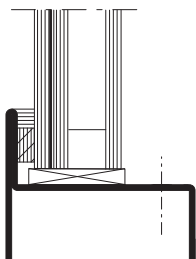

Glasklotz einsetzen
 Poser la cale
 Insert glazing block

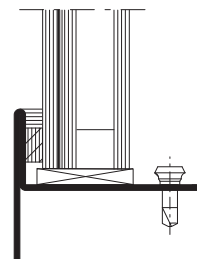

Glaselement einsetzen
 Poser l'élément de vitrage
 Insert glass pane

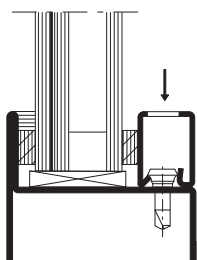

Glasleiste mit aufgeklebtem Distanzband montieren
 Clipser la parclose avec la bande d'écartement collée
 Clip the glazing bead with the glued-on packing strip on one side

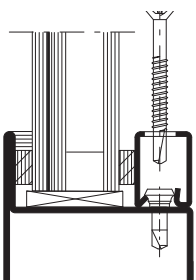

Fugen innen und aussen versiegeln
 Sceller le joint intérieur et extérieur
 Seal the joint inside and outside

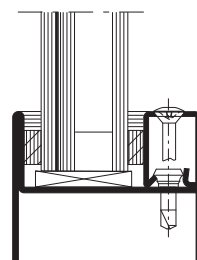

Situation mit Alu-Glasleiste
 Situation avec parclose en aluminium
 Situation with aluminium glazing bead

Bedingt durch verschiedene Toleranzen (Profile, Glasleisten, Anordnung Befestigungsknöpfe, Distanzbänder und Glaselemente) empfehlen wir, die Wahl der Distanzbänder vorgängig an einem Element zu prüfen.

A cause des différentes tolérances (profilés, parcloles, disposition boutons de fixation, bandes de distance et éléments vitrés) nous recommandons d'effectuer un essai préalable avec la bande de distance choisie sur un élément.

Owing to variations in the tolerances (profiled sections, glazing beads, layout of coupling studs, packing strips and glazing) it is advisable to check your choice of packing strips on an infill panel beforehand.

Betreffend Fugendimensionierung und Fugenausbildung verweisen wir auf die Richtlinien der Glashersteller.

En ce qui concerne le dimensionnement et la formation des joints nous renvoyons aux directives du fabricant de verre.

Referring to joint dimensioning and joint form we refer you to the guidelines of glass manufacturer.

Abstände Befestigungsfeder 450.023
 und Schraube 450.024

Distance entre ressort de
 fixation 450.023 et vis 450.024

Distance between fastening
 spring 450.023 and screw 450.024

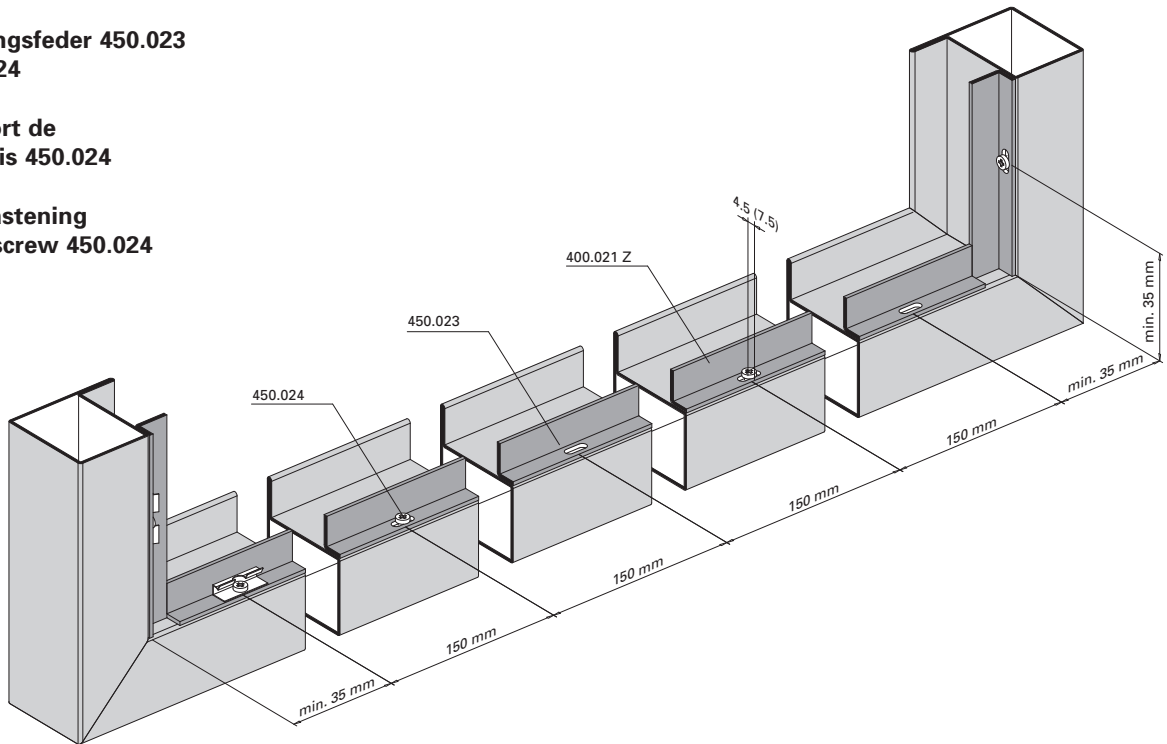

Bestimmung der Distanzbänder
 und des Falzspiels

Détermination des bandes
 d'écartement et les jeu de feuillure

Determining packing strips and
 rebate allowance

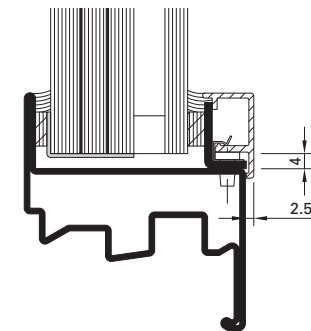
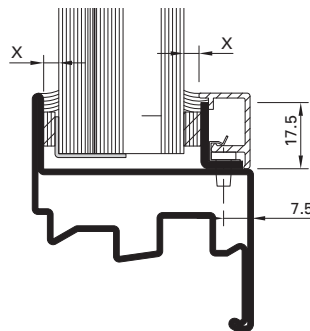
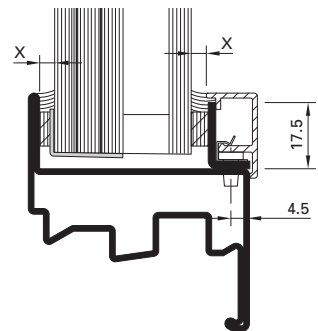
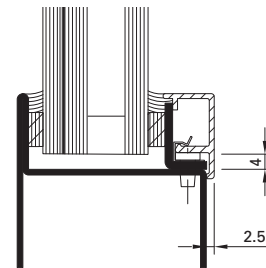
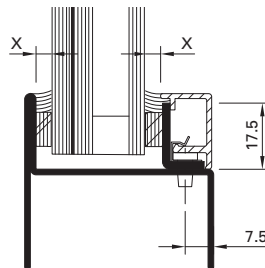
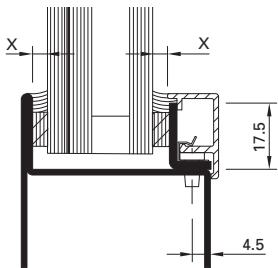

Stahlwinkel 400.021 Z
 Alu-Abdeckleiste 406.997
 Cornière en acier 400.021 Z
 Parcloses en aluminium 406.997
 Steel angle 400.021 Z
 Aluminium cover strip 406.997

Stahlwinkel 400.021 Z
 Alu-Abdeckleiste 406.999
 Cornière en acier 400.021 Z
 Parcloses en aluminium 406.999
 Steel angle 400.021 Z
 Aluminium cover strip 406.999

Falzspiel
 Jeu de feuillure
 Rebate allowance

X:
 Distanzbanddicke =
 Fugenbreite

X:
 Epaisseur de la bande d'écartement =
 Largeur de joint

X:
 Thickness of packing strip =
 Width of joint

Ablaufschritte Glaseinbau

Procédure pour la pose des vitres

Steps in fitting glass panes

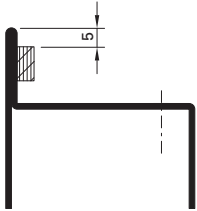

Distanzband auf Profillappen kleben
 Coller la bande d'écartement sur la battue du profilé
 Attach packing strip to section flange

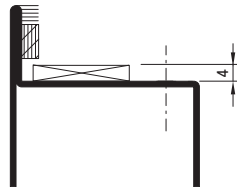

Glasklotz einsetzen
 Poser la cale
 Insert glazing block

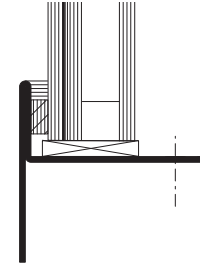

Glaselement einsetzen
 Poser l'élément de vitrage
 Insert glass pane

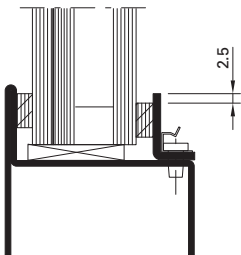

400.021 Z mit aufgeklebtem Distanzband montieren, abwechselnd mit 450.023 und 450.024 befestigen.
 Monter l'équerre 400.021 Z équipée de la bande de distance et la visser en alternant avec 450.023 et 450.024.
 Install 400.021 Z with glued on packing strip and fasten alternating with 450.023 and 450.024.

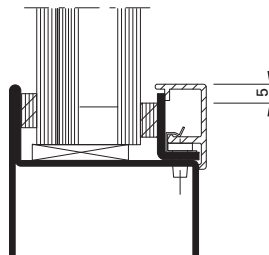

Mit Alu-Abdeckleiste abdecken
 A recouvrir avec le profilé de recouvrement en aluminium
 Cover with aluminium cover profile

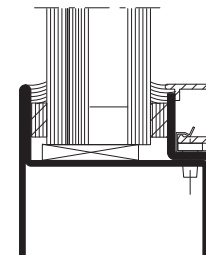

Fugen innen und aussen versiegeln
 Sceller le joint intérieur et extérieur
 Seal the joint inside and outside

Bedingt durch verschiedene Toleranzen (Profile, Glasleisten, Anordnung Befestigungsknöpfe, Distanzbänder und Glaselemente) empfehlen wir, die Wahl der Distanzbänder vorgängig an einem Element zu prüfen.

A cause des différentes tolérances (profilés, parcloles, disposition boutons de fixation, bandes de distance et éléments vitrés) nous recommandons d'effectuer un essai préalable avec la bande de distance choisie sur un élément.

Owing to variations in the tolerances (profiled sections, glazing beads, layout of coupling studs, packing strips and glazing) it is advisable to check your choice of packing strips on an infill panel beforehand.

Betreffend Fugendimensionierung und Fugenausbildung verweisen wir auf die gültigen DIN-Normen 18545, resp. auf die Richtlinien der Glashersteller.

En ce qui concerne le dimensionnement et la formation des joints nous renvoyons aux norme DIN 18545 actuellement en vigueur, respectivement aux directives du fabricant de verre.

Referring to joint dimensioning and joint form we refer you to DIN standard 18545, respectively to the guidelines of glass manufacturer.

Mauerwerk

Die umgebenden Wände, in welche die Fenster eingebaut wird, müssen folgende Mindestanforderungen erfüllen:

Maçonnerie

Les parois environnantes dans lesquelles les fenêtres sont montées doivent répondre aux exigences minimales requises suivantes:

Masonry

The surrounding walls into which the window is inserted must meet the following minimum requirements:

Widerstands- klasse	Umgebende Wände / Parois environnantes / Surrounding walls				
	aus Mauerwerk nach DIN 1053 Teil 1 en maçonnerie selon DIN 1053 partie 1 Masonry in accordance with DIN 1053 Part 1			aus Stahlbeton nach DIN 1045 en béton armé selon DIN 1045 Reinforced concrete in accordance with DIN 1045	
	Nenndicke Epaisseur nominale Nominal thickness mm	Druckfestigkeits- klasse Classe de résistance à la pression Compressive strength class	Mörtelgruppe Groupe de mortier Mortar class	Nenndicke Epaisseur nominale Nominal thickness mm	Festigkeitsklasse Classe de résistance Compressive strength class
RC2	≥ 115	≥ 12	min. MG II / DM	≥ 100	B 15
RC3	≥ 115	≥ 12	min. MG II / DM	≥ 120	B 15

Beispiele für zulässige Wandanschlüsse

Die Fenster können mit Rahmendübeln befestigt werden. Abstand der Befestigungspunkte von den Ecken max. 200 mm, Abstand untereinander max. 400 mm. Der Spalt zwischen Blendrahmen und Mauerwerk muss bei jedem Befestigungspunkt druckfest ausgefüllt werden. Verbleibenden Hohlraum isolieren und abdichten.

Exemples pour raccordements au mur autorisés

Les fenêtres peuvent, au choix, être fixées avec des goujons d'ancrage ou des éclisses à souder ou à visser. Espacement entre les points de fixation et les angles: max. 200 mm, espacement entre les uns et les autres: max. 400 mm. L'espace entre le dormant et la maçonnerie doit être comblé à chaque point de fixation de manière à résister à la pression. Remplir l'espace vide restant avec de mousse.

Examples of permissible wall attachments

The windows can be fixed with frame anchors. The distance of the fixing points from the corners is a maximum of 200 mm, the distance between each other is a maximum of 400 mm. The gap between the outer frame and the masonry has to be filled with compression-resistant material for every fixing point. Insulate remaining space and seal.

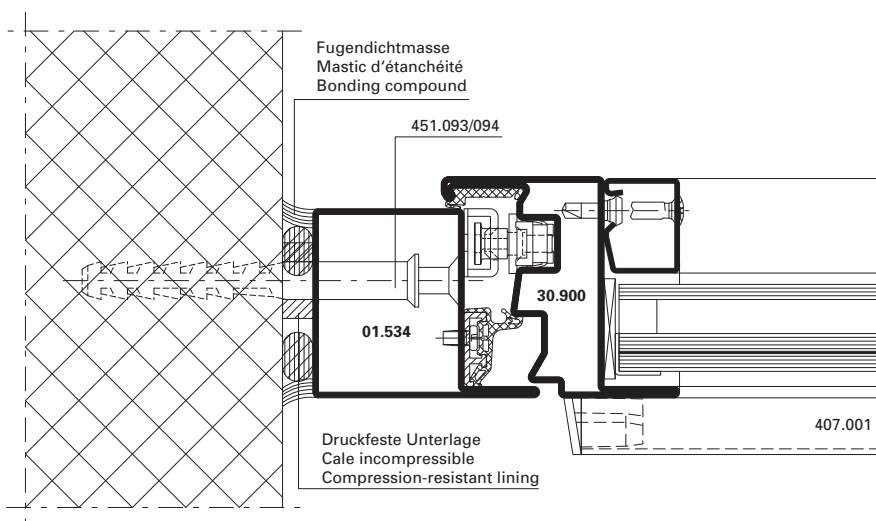

D-201-A-801

DXF

DWG

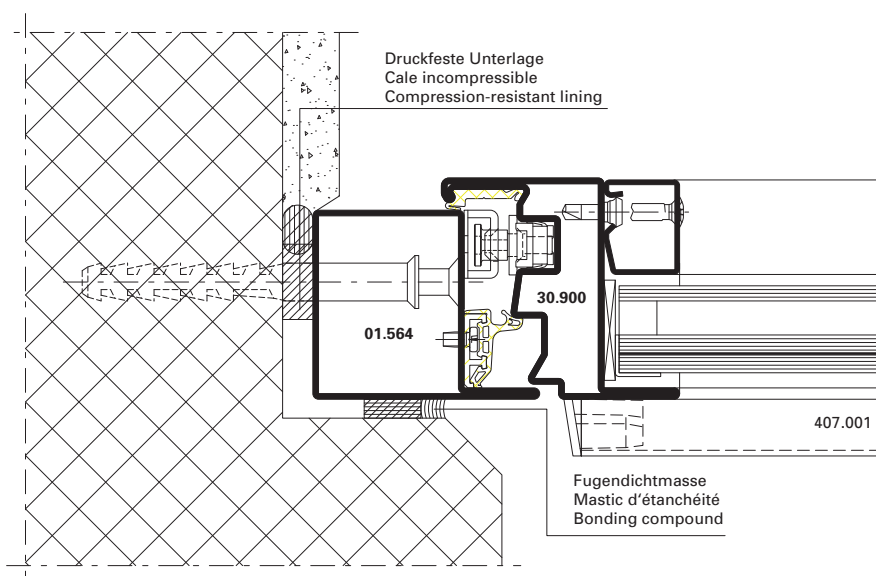

D-201-A-802

DXF

DWG

CE Kennzeichnung
Marquage CE
CE marking

Economy 50 Fenster einbruchhemmend
Fenêtres Economy 50 anti-effraction
Economy 50 windows burglar resistant

CE Kennzeichnung und Leistungserklärungen

Alle nötigen Unterlagen und Anleitungen zur CE-Kennzeichnung finden Sie unter

www.extranet.jansen.com

Ebenfalls finden Sie unter dieser Adresse alle Leistungserklärungen unserer Beschläge.

Marquage CE et déclarations de performance

Tous les documents et instructions relatifs au marquage CE se trouvent sur le site

www.extranet.jansen.com

Vous trouverez également à cette adresse toutes les déclarations de performance de nos ferrures.

CE marking and declarations of performance

You can find all the necessary documents and instructions on CE marking at

www.extranet.jansen.com

At this address you can also find all declarations of performance for our fittings.

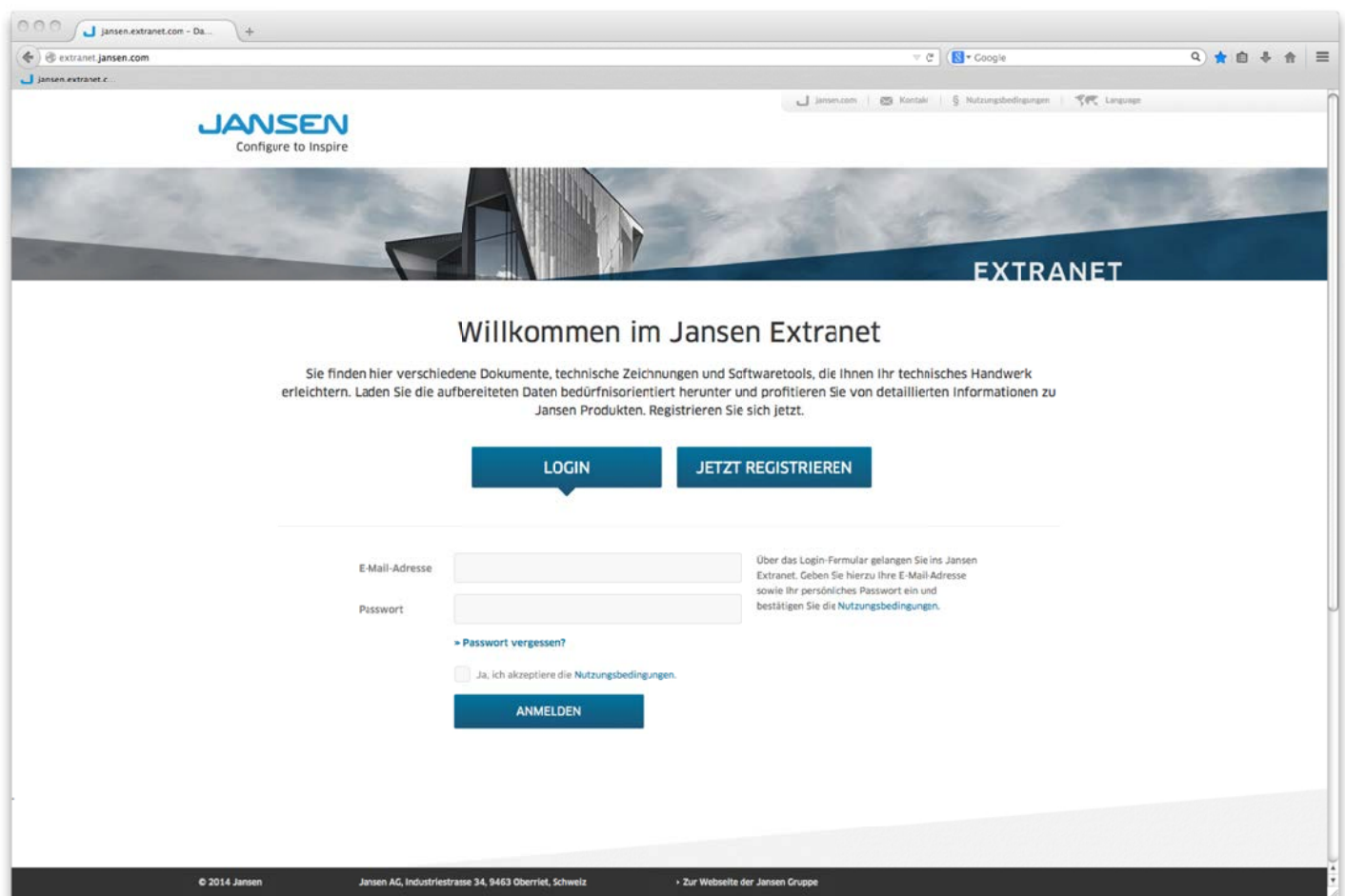

Verarbeitungs-Hinweise
Indications d'usage
Assembly instructions

Economy 50 Fenster einbruchhemmend
Fenêtres Economy 50 anti-effraction
Economy 50 windows burglar resistant

**Bedienungs-, Pflege- und
Wartungsanleitung siehe
Dokumentation 598.461**

**Instructions d'emploi,
d'entretien et de maintenance
voir documentation 598.468**

**Operating and maintenance
instructions see
documentation 598.467**



Jansen AG

Steel Systems
Industriestrasse 34
9463 Oberriet
Schweiz
jansen.com

