

# VISS Fassade

Lieferprogramm

# VISS façade

Programme de livraison

# VISS façade

Sales range

**Lieferprogramm  
VISS Fassade (10/2015)**

Code A = Änderungen  
Code E = Ergänzungen

**Programme de livraison  
VISS façade(10/2015)**

Code A = Modifications  
Code E = Compléments

**Sales range  
VISS façade (10/2015)**

Code A = Modifications  
Code E = Additions

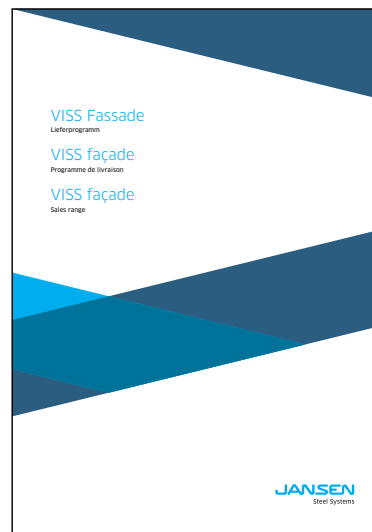

Seite Page Page	Code Code Code	Datum Date Date	Erläuterung Explication Explanation
22-9	A	01/2016	Hinweis hinzugefügt Remarque ajoutée Added note
22-8	E	02/2016	2 neue Profile: 76.143 Z und 76.144 Z 2 nouveaux profilés: 76.143 Z et 76.144 Z 2 new profiles: 76.143 Z and 76.144 Z

---

**Inhaltsverzeichnis****Sommaire****Content**

---

VISS Fassade

VISS façade

VISS façade

---

---

**Systemübersicht**Merkmale  
Zulassungen**Sommaire du système**Caractéristiques  
Homologations**Summary of system**Characeteristics  
Authorisations**2**

---

**Profilsortiment**Profile 50 und 60 mm  
Deckprofile 50 und 60 mm  
Zubehör**Assortiment de profilé**Profilés 50 et 60 mm  
Profilés de recouvrement 50 et 60 mm  
Accessoires**Range of profiles**Profiles 50 and 60 mm  
Cover sections 50 and 60 mm  
Accessories**6**

---

**Konstruktions-Hinweise**Schnittpunkte  
Konstruktions-Details  
Anschlüsse am Bau  
System-Hinweise**Indications du construction**Coupes de détails  
Détails de construction  
Raccords au mur  
Remarques concernant les systèmes**Construction instructions** **33**Section details  
Construction details  
Attachment to structure  
System instructions

Alle Ausführungen dieser Dokumentation haben wir sorgfältig und nach bestem Wissen zusammengestellt. Wir können aber keine Verantwortung für die Benützung der vermittelten Vorschläge und Daten übernehmen. Wir behalten uns technische Änderungen ohne Vorankündigung vor.  
Aktuelle Version auf [www.jansen.com](http://www.jansen.com)

Nous avons apporté le plus grand soin à l'élaboration de cette documentation. Cependant, nous déclinons toute responsabilité pour l'utilisation faite de nos propositions et de nos données.  
Nous nous réservons le droit de procéder à des modifications techniques sans préavis.  
Version actuelle sur [www.jansen.com](http://www.jansen.com)

All the information contained in this documentation is given to the best of our knowledge and ability. However, we decline all responsibility for the use made of these suggestions and data.  
We reserve the right to effect technical modifications without prior warning.  
Current version available at [www.jansen.com](http://www.jansen.com)

---

## Merkmale

### Caractéristiques

### Characteristics

---

- CE-Kennzeichnung nach EN 13830
- $U_{CW}$ , eingebaut Werte bis  $0.73 \text{ W/m}^2\text{K}$
- $U_f$  Werte bis  $0.65 \text{ W/m}^2\text{K}$
- Ansichtsbreiten 50 und 60 mm
- Füllelementstärken 6 bis 70 mm
- Standardprofile ab Lager mit  $I_x$  Werten bis  $1964 \text{ cm}^4$
- Füllelementgewichte bis 1800 kg
- Kombinierbar mit der Aufsatzkonstruktion VISS Basic, der Brandschutzlösung VISS Fire und der Einbruchhemmenden Variante VISS RC

- Marquage CE selon EN 13830
- Valeurs  $U_{CW}$  (monté) jusqu'à  $0.73 \text{ W/m}^2\text{K}$
- Valeurs  $U_f$  jusqu'à  $0.65 \text{ W/m}^2\text{K}$
- Largeurs de face 50 et 60 mm
- Éléments de remplissage de 6 à 70 mm d'épaisseur
- Profilés standard disponibles en magasin avec valeurs  $I_x$  jusqu'à  $1964 \text{ cm}^4$
- Poids de remplissage jusqu'à 1800 kg
- Combinable avec la construction rapportée VISS Basic, la protection incendie VISS Fire et la variante anti-effraction VISS RC

---

## VISS Fassade

### VISS façade









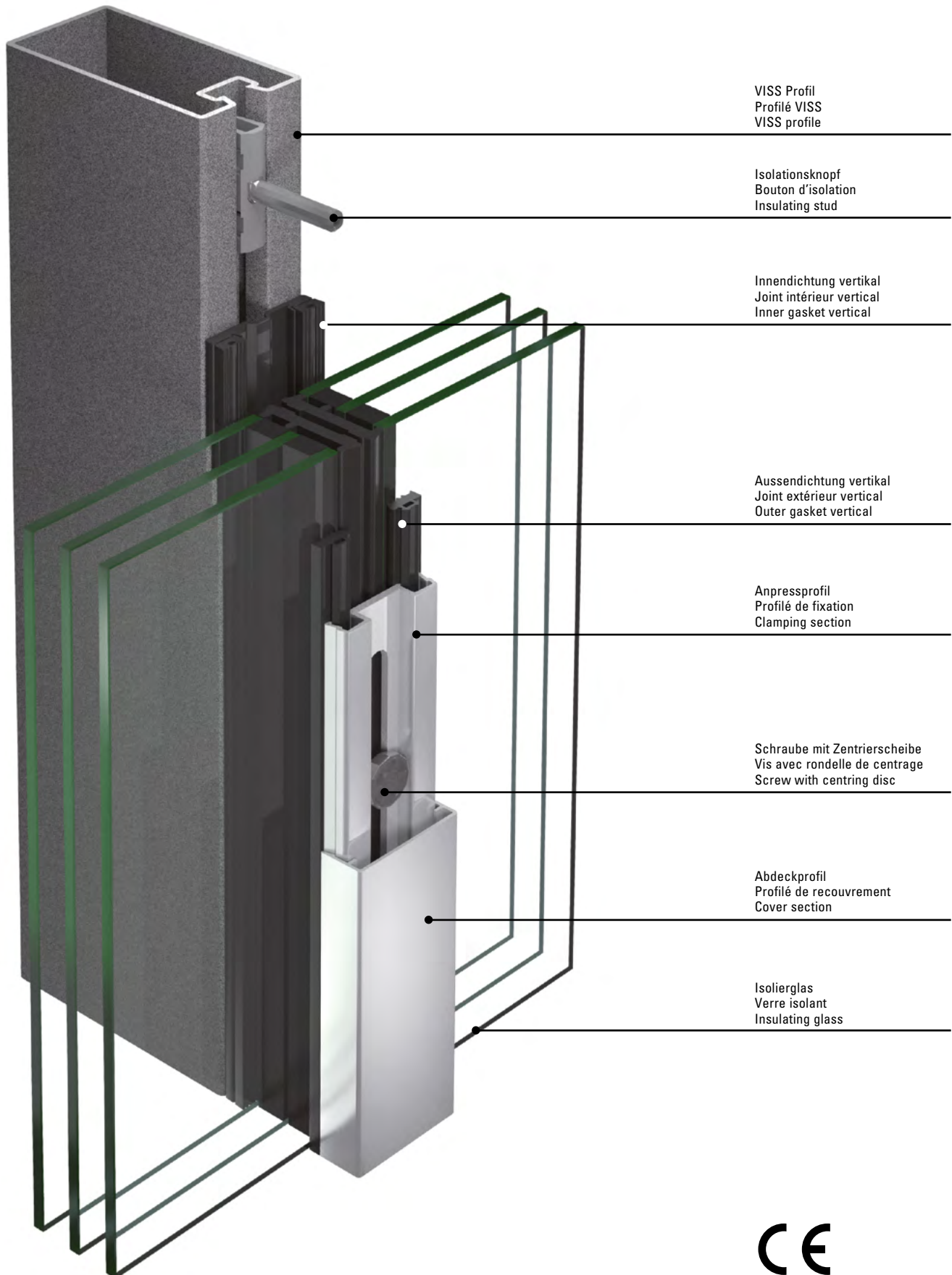



### VISS façade

---

- CE marking in accordance with EN 13830
- $U_{CW}$ , installed values to  $0.73 \text{ W/m}^2\text{K}$
- $U_f$  values to  $0.65 \text{ W/m}^2\text{K}$
- 50 and 60 mm face widths
- Infill panel thicknesses of 6 to 70 mm
- Standard profiles from stock with  $I_x$  values to  $1964 \text{ cm}^4$
- Infill unit weights up to 1800 kg
- Can be combined with the VISS Basic add-on construction, the VISS Fire fire protection solution and the VISS RC burglar-resistant version





	Prüfungen (Prüfnorm) Essais (Norme d'essai) Tests (Test standard)	Klassifizierungs-Norm Norme de classification Classification standard	Werte Valeurs Values
	Schlagregendichtheit (EN 12155) Etanchéité à la pluie battante (EN 12155) Watertightness (EN 12155)	EN 12154	RE 1200
	Widerstand bei Windlast (EN 12179) Résistance à la pression du vent (EN 12179) Resistance to wind load (EN 12179)	EN 13116	Bemessungslast 2 kN/m <sup>2</sup> Charge de calcul 2 kN/m <sup>2</sup> Designed load 2 kN/m <sup>2</sup>
	Luftdurchlässigkeit (EN 12153) Perméabilité à l'air (EN 12153) Air permeability (EN 12153)	EN 12152	Klasse AE Classe AE Class AE
	Wärmedurchgangskoeffizient (EN 13947) Transmission thermique (EN 13947) Thermal transmittance (EN 13947)	EN ISO 10077-2	ab $U_f > 0.65 \text{ W/m}^2\text{K}$ dès $U_f > 0.65 \text{ W/m}^2\text{K}$ from $U_f > 0.65 \text{ W/m}^2\text{K}$
	Schallschutz (EN ISO 140-3) Isolation phonique (EN ISO 140-3) Sound insulation (EN ISO 140-3)	EN ISO 717-1	$R_w$ 47 dB (-1; -5) (C, Ctr)
	Einbruchhemmung Anti-effraction Burglar resistance	prEN 1627	RC2 / RC3 / RC4
	Durchschusshemmung (EN 1523) Résistance aux balles (EN 1523) Bullet proofing (EN 1523)	EN 1522	FB4 NS
	Stoßfestigkeit Résistance au chocs Impact strength	EN 14019	Klasse E5 / I5 Classe E5 / I5 Class E5 / I5
	Brandverhalten Réaction au feu Reaction to fire	EN 13501-1	Klasse E Classe E Class E
	Längsschalldämmung Isolation acoustique longitudinale Insulation against flanking transmission	prEN ISO 10848-2 (4/2004)	vertikal 62 dB horizontal 59 dB
	Technische Regeln für die Verwendung von absturzsichernden Verglasungen Règlement technique pour la sécurité anti-chute des vitrages The technical regulations for protecting glazing against falling out	TRAV	Kategorie A Catégorie A Category A

**Avis Technique (Frankreich)**  
Fassade VISS TV 1S  
Zulassung Nr. 02/12-1501,  
C.S.T.B. Marne la Vallée/FR

**Avis Technique (France)**  
Façade VISS TV 1S  
Autorisation no 02/12-1501,  
C.S.T.B. Marne la Vallée/FR

**Avis Technique (France)**  
Façade VISS TV 1S  
Autorisation nr. 02/12-1501,  
C.S.T.B. Marne la Vallée/FR

**Klemmverbindung (Deutschland)**  
AbZ Z-14.4-459 (Isolationsknöpfe)

**Jonction par serrage (Allemagne)**  
AbZ Z-14.4-459 (bouton d'isolation)

**Clamp connection (Germany)**  
AbZ Z-14.4-459 (insulation studs)

**CWCT-Test**  
Die Fassade wurde nach den  
Anforderungen des CWCT geprüft.

**Test CWCT**  
La façade a été contrôlée suivant les  
exigences du CWCT.

**CWCT test**  
The facades were certified in compliance  
with the requirements of the CWCT.

Luftdurchlässigkeit/  
Wasserdichtheit: PASS  
Zulässige Windlast 2400 Pa  
Sicherheitslast 3600 Pa

Perméabilité à l'air/  
Étanchéité à l'eau: PASS  
Charge du vent admissible 2400 Pa  
Charge de sécurité 3600 Pa

Air permeability/  
Watertightness: PASS  
Permissible wind load 2400 Pa  
Security load 3600 Pa

**Passivhaus-Zertifikat**

**Zertifikat**  
Zertifizierte Passivhaus Komponente  
für kühl gemäßigtes Klima, gültig bis 31.12.2015

Passivhaus Institut  
Dr. Wolfgang Feist  
64283 Darmstadt  
GERMANY

Category: **Pfosten-Riegel-Fassade**  
Hersteller: **Jansen AG**  
6463 Oberriet SG, SWITZERLAND  
VISS HI

Produkt: **VISS HI**

Folgende Behaglichkeitskriterien wurden für die  
Zuerkennung des Zertifikates geprüft:

Mit  $U_g = 0,7 \text{ W/(m}^2\text{K)}$  und bei einem Modulmaß von  
1,20 m \* 2,50 m ergibt sich:

$U_{CW} = 0,80 \text{ W/(m}^2\text{K)} \leq 0,80 \text{ W/(m}^2\text{K)}$

Einschließlich Einbaudämmbrücken erfüllt die Fassade  
folgende Bedingung, vorausgesetzt der Einbau erfolgt wie im  
Datenblatt angegeben bzw. thermisch gleich- oder höherwertig.

$U_{CW, eingebaut} \leq 0,85 \text{ W/(m}^2\text{K)}$

Folgende Kennwerte wurden ermittelt:

	U-Wert [W/(m <sup>2</sup> K)]	Breite [mm]	$\Psi_g$ [W/(m <sup>2</sup> K)]	$f_{\text{Rel}}=0,2$ [-]
Abstandhalter			Swisspacer V*	
Riegel (I)	0,92	50	0,037	0,81
Pfosten (m)	0,81	50	0,037	
Glasträger-Wärmebrücke $\chi_{0,01}$ [W/K]:				0,008

\*Spacers of lower thermal quality, especially those made of alu-  
minium, lead to significantly higher thermal losses and lower  
temperature factors.

Weitere Informationen siehe Datenblatt

www.passiv.de 0157cw03

ZERTIFIZIERTE  
KOMPONENTE  
Passivhaus Institut

**Certificat maison passive**

**Certificate**  
Certified Passive House component  
for cool, temperate climate, valid until 31.12.2015

Passive House Institute  
Dr. Wolfgang Feist  
64283 Darmstadt  
GERMANY

Category: **Curtain Wall**  
Manufacturer: **Jansen AG**  
6463 Oberriet SG, SWITZERLAND  
VISS HI

Product name: **VISS HI**

The following comfort criteria were used in  
awarding this certificate:

Given a  $U_g$  value of  $0,7 \text{ W/(m}^2\text{K)}$  and an element size of  
1,20 m by 2,50 m,

$U_{CW} = 0,80 \text{ W/(m}^2\text{K)} \leq 0,80 \text{ W/(m}^2\text{K)}$

Taking into account the installation based thermal bridges, and  
provided that the installation is, with regard to the thermal bridges,  
equal or better than shown in the data sheet, the facade meets  
the following criterion.

$U_{CW, eingebaut} \leq 0,85 \text{ W/(m}^2\text{K)}$

Thermal data of the construction

	U-value [W/(m <sup>2</sup> K)]	Width [mm]	$\Psi_g$ [W/(m <sup>2</sup> K)]	$f_{\text{Rel}}=0,2$ [-]
Spacer			Swisspacer V*	
Transom (I)	0,92	50	0,037	0,81
Mullion (m)	0,81	50	0,037	
Thermal glass carrier bridge $\chi_{0,01}$ [W/K]:				0,008

\*Spacers of lower thermal quality, especially those made of alu-  
minium, lead to significantly higher thermal losses and lower  
temperature factors.

Further information see data sheet

www.passivehouse.com 0157cw03

CERTIFIED  
COMPONENT  
Passive House Institute

**Passive house certificate**

**Certificate**  
Certified Passive House component  
for cool, temperate climate, valid until 31.12.2015

Passive House Institute  
Dr. Wolfgang Feist  
64283 Darmstadt  
GERMANY

Category: **Curtain Wall**  
Manufacturer: **Jansen AG**  
6463 Oberriet SG, SWITZERLAND  
VISS HI

Product name: **VISS HI**

The following comfort criteria were used in  
awarding this certificate:

Given a  $U_g$  value of  $0,7 \text{ W/(m}^2\text{K)}$  and an element size of  
1,20 m by 2,50 m,

$U_{CW} = 0,80 \text{ W/(m}^2\text{K)} \leq 0,80 \text{ W/(m}^2\text{K)}$

Taking into account the installation based thermal bridges, and  
provided that the installation is, with regard to the thermal bridges,  
equal or better than shown in the data sheet, the facade meets  
the following criterion.

$U_{CW, eingebaut} \leq 0,85 \text{ W/(m}^2\text{K)}$

Thermal data of the construction

	U-value [W/(m <sup>2</sup> K)]	Width [mm]	$\Psi_g$ [W/(m <sup>2</sup> K)]	$f_{\text{Rel}}=0,2$ [-]
Spacer			Swisspacer V*	
Transom (I)	0,92	50	0,037	0,81
Mullion (m)	0,81	50	0,037	
Thermal glass carrier bridge $\chi_{0,01}$ [W/K]:				0,008

\*Spacers of lower thermal quality, especially those made of alu-  
minium, lead to significantly higher thermal losses and lower  
temperature factors.

Further information see data sheet

www.passivehouse.com 0157cw03

CERTIFIED  
COMPONENT  
Passive House Institute

**Profile 50 mm (Massstab 1:3)**

**Profils 50 mm (échelle 1:3)**

**Profiles 50 mm (scale 1:3)**

**VISS Fassade**

**VISS façade**

**VISS façade**

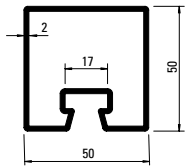

**76.694**  
**76.694 Z**

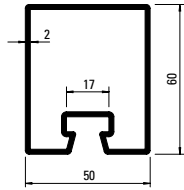

**76.671**  
**76.671 Z**

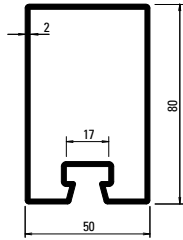

**76.696**  
**76.696 Z**

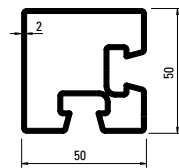

**76.094**  
**76.094 GV+GC**

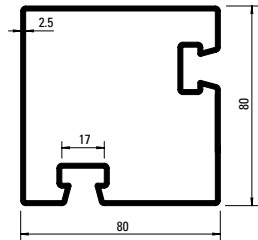

**76.096**  
**76.096 GV+GC**

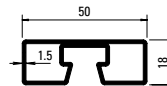

**76.692**  
**76.692 GV+GC**

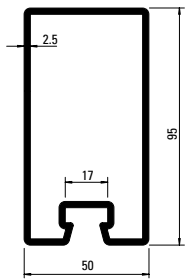

**76.697**  
**76.697 Z**

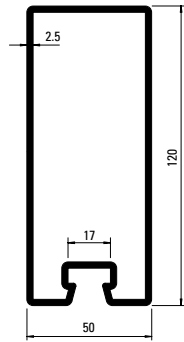

**76.679**  
**76.679 Z**

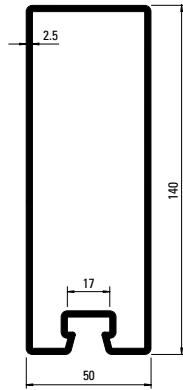

**76.666**  
**76.666 Z**

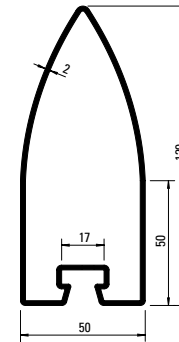

**76.105**  
**76.105 GV+GC**

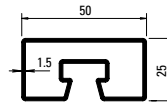

**76.682**  
**76.682 GV+GC**

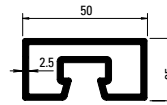

**76.680**  
**76.680 GV+GC**

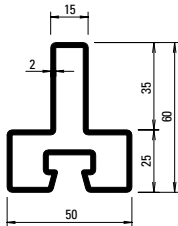

**76.114**  
**76.114 GV+GC**

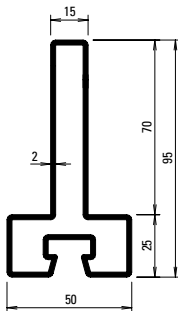

**76.115**  
**76.115 GV+GC**

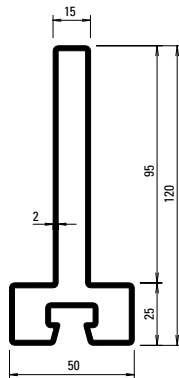

**76.116**  
**76.116 GV+GC**

Profil-Nr.	G kg/m	F cm <sup>2</sup>	I <sub>x</sub> cm <sup>4</sup>	W <sub>x</sub> cm <sup>3</sup>	I <sub>y</sub> cm <sup>4</sup>	W <sub>y</sub> cm <sup>3</sup>	U m <sup>2</sup> /m	L mm
<b>76.094</b>	4,090	5,21	15,20	5,90	15,20	5,90	0,280	6000
<b>76.096</b>	7,437	9,462	83,79	20,52	83,79	20,52	0,391	6000
<b>76.105</b>	5,190	6,62	97,55	13,62	22,71	9,08	0,338	6000
<b>76.666</b>	7,910	10,1	240,0	32,10	43,50	17,40	0,412	6500
<b>76.671</b>	3,860	4,90	23,2	7,20	17,30	6,90	0,260	6500
<b>76.679</b>	7,120	9,07	162,0	25,20	37,90	15,20	0,373	6500
<b>76.680</b>	3,390	4,32	3,17	2,38	11,08	4,43	0,182	6100
<b>76.682</b>	2,120	2,70	2,34	1,81	7,20	2,90	0,190	6000
<b>76.692</b>	1,900	2,52	0,85	0,81	6,00	2,40	0,176	6000
<b>76.694</b>	3,500	4,50	15,0	5,70	14,80	5,90	0,240	6500
<b>76.696</b>	4,450	5,70	48,4	11,50	21,80	8,70	0,300	6500
<b>76.697</b>	6,100	7,90	92,0	17,90	31,00	12,40	0,330	6500
<b>76.114</b>	3,820	4,87	15,36	4,14	9,79	3,91	0,251	6000
<b>76.115</b>	4,920	6,27	54,76	9,31	10,38	4,15	0,321	6000
<b>76.116</b>	5,710	7,27	105,00	14,31	10,81	4,32	0,371	6000

Profile 60 mm (Masstab 1:3)  
 Profilés 60 mm (échelle 1:3)  
 Profiles 60 mm (scale 1:3)

VISS Fassade  
 VISS façade  
 VISS façade

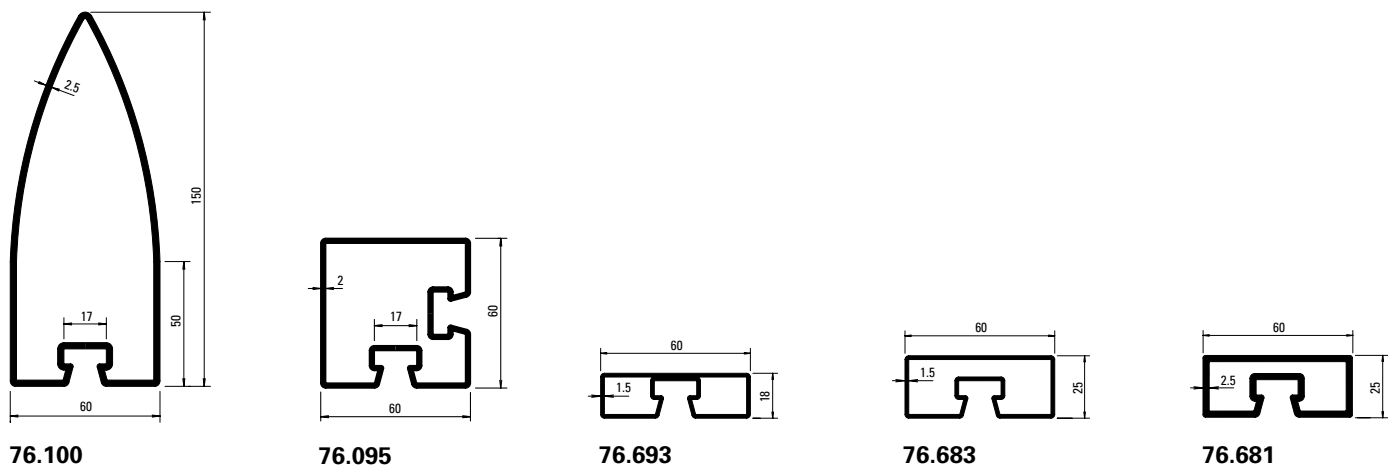
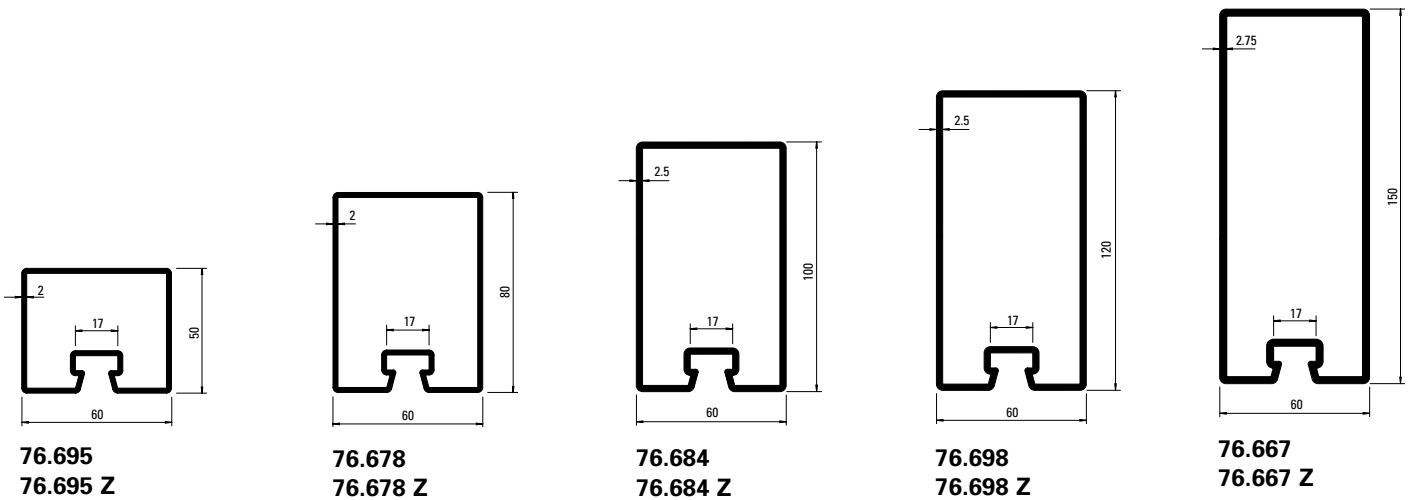

Artikelbibliothek  
 Bibliothèque des articles  
 Article library

**DXF** **DWG**

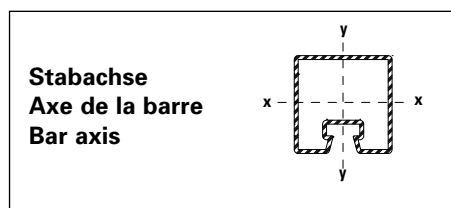

Profil-Nr.	G kg/m	F cm <sup>2</sup>	I <sub>x</sub> cm <sup>4</sup>	W <sub>x</sub> cm <sup>3</sup>	I <sub>y</sub> cm <sup>4</sup>	W <sub>y</sub> cm <sup>3</sup>	U m <sup>2</sup> /m	L mm
<b>76.095</b>	4,750	6,05	27,2	8,56	27,17	8,56	0,311	6000
<b>76.100</b>	7,840	9,98	231,8	26,07	47,87	15,96	0,409	6000
<b>76.667</b>	9,530	12,10	343,0	43,00	75,10	25,00	0,452	6500
<b>76.678</b>	4,800	6,11	53,9	12,60	33,20	11,10	0,320	6500
<b>76.681</b>	3,790	4,82	3,81	2,89	17,29	5,76	0,202	6100
<b>76.683</b>	2,360	3,00	2,77	2,14	11,20	3,70	0,210	6000
<b>76.684</b>	6,730	8,57	114,0	21,30	48,30	16,10	0,352	6500
<b>76.693</b>	2,140	2,82	1,20	1,10	9,50	3,10	0,196	6000
<b>76.695</b>	3,800	4,90	17,6	6,70	22,80	7,60	0,260	6500
<b>76.698</b>	7,500	9,67	183,0	28,30	55,50	18,50	0,400	6500

Profile 60 mm (Massstab 1:3)

Profils 60 mm (échelle 1:3)

Profiles 60 mm (scale 1:3)

VISS Fassade

VISS façade

VISS façade

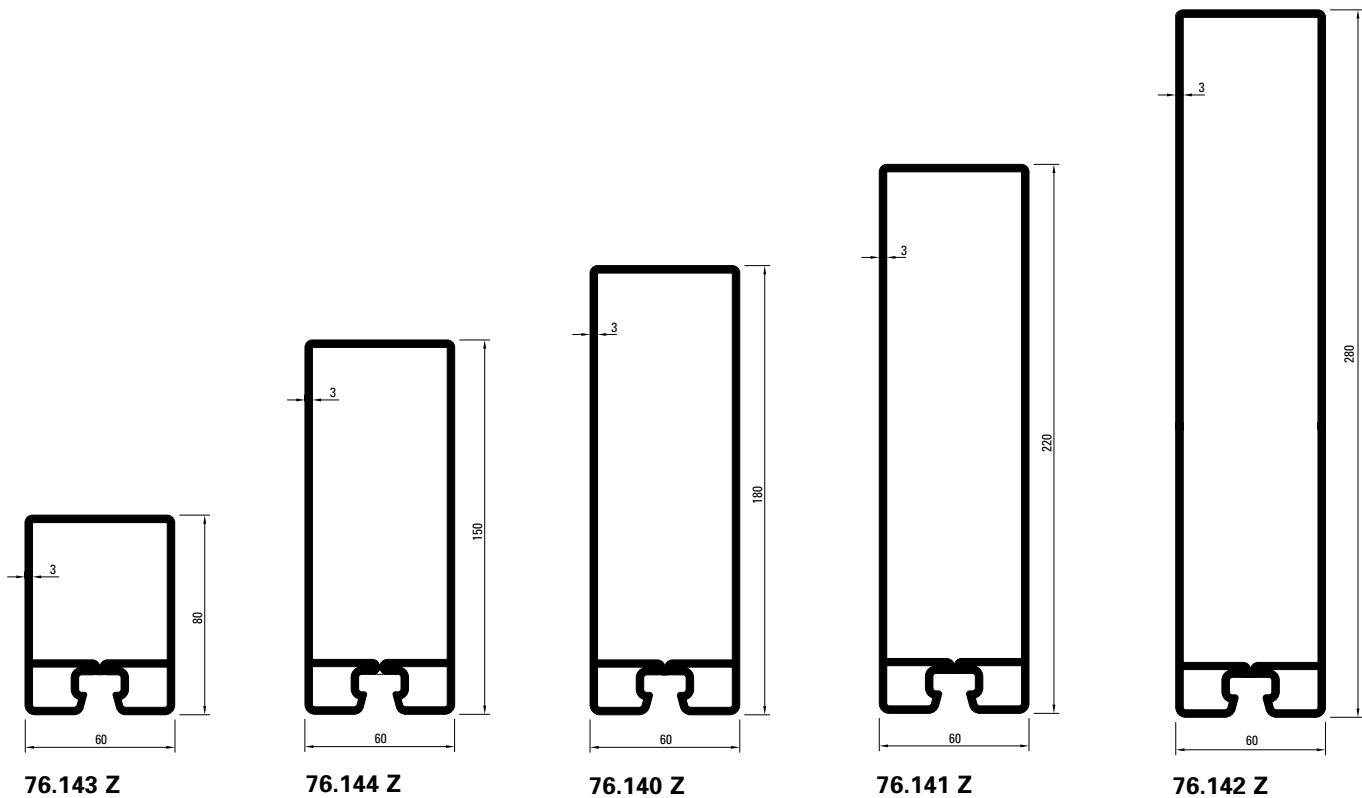

Profil-Nr.	G kg/m	F cm <sup>2</sup>	I <sub>x</sub> cm <sup>4</sup>	W <sub>x</sub> cm <sup>3</sup>	I <sub>y</sub> cm <sup>4</sup>	W <sub>y</sub> cm <sup>3</sup>	U m <sup>2</sup> /m	L mm
<b>76.140 Z</b>	12,946	16.471	644.22	63.96	99.40	33.13	0,516	8000
<b>76.141 Z</b>	14.833	18.871	1082.0	88.67	118.91	39.64	0,596	8000
<b>76.142 Z</b>	17,662	22,47	2026,87	132,09	148,18	49,39	0,716	10000
<b>76.143 Z</b>	8.340	10.62	71.71	17.17	45.32	15.11	0.316	6500
<b>76.144 Z</b>	11.630	14.82	347.15	44.36	79.16	26.39	0.456	6500

**Deckprofile 50 mm (Masstab 1:3)**  
**Profils de recouvrement 50 mm (échelle 1:3)**  
**Cover sections 50 mm (scale 1:3)**

VISS Fassade  
 VISS façade  
 VISS façade

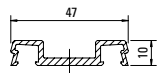

**407.800**

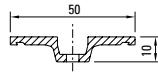

**407.821**



**407.823**

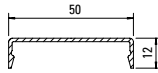

**407.860**

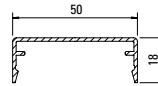

**407.861**

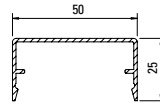

**407.862**

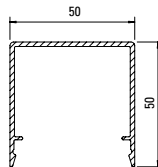

**407.863**

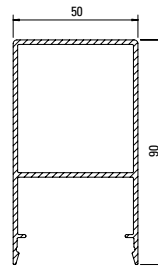

**407.864**

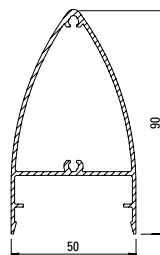

**407.914**

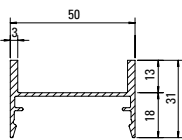

**407.900**

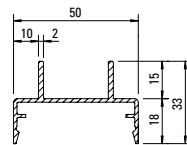

**407.911**

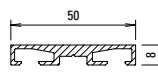

**407.818\*\***

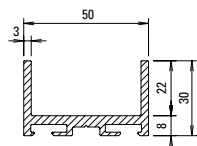

**407.817\***

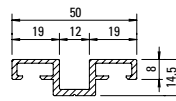

**407.858\*\***

\* Sonderkonstruktion (nach Produktnorm EN 13830 nicht geprüft). Einsatz nur im Pfostenbereich.

\* Construction spéciale (non contrôlé selon la norme produit EN 13830). Utilisation uniquement dans la zone du montant.

\* Special construction (Not tested in accordance with the EN 13830 product standard). Only for use in mullion area.

\*\* Sonderkonstruktion (nach Produktnorm EN 13830 nicht geprüft).

\*\* Construction spéciale (non contrôlé selon la norme produit EN 13830).

\*\* Special construction (Not tested in accordance with the EN 13830 product standard).

Profil-Nr.	G kg/m	U m <sup>2</sup> /m	P m <sup>2</sup> /m	L mm
<b>407.800</b>	0,414	0,160		6000
<b>407.821</b>	0,440	0,143	0,067	6000
<b>407.823</b>	0,076	0,043	0,019	6000
<b>407.817</b>	1,030	0,253	0,154	6000
<b>407.818</b>	0,520	0,176	0,066	6000
<b>407.858</b>	0,530	0,203	0,087	6000
<b>407.860</b>	0,266	0,147	0,072	6000

Profil-Nr.	G kg/m	U m <sup>2</sup> /m	P m <sup>2</sup> /m	L mm
<b>407.861</b>	0,341	0,185	0,084	6000
<b>407.862</b>	0,394	0,213	0,098	6000
<b>407.863</b>	0,660	0,313	0,148	6000
<b>407.864</b>	1,344	0,360	0,228	6000
<b>407.900</b>	0,556	0,240	0,138	6000
<b>407.911</b>	0,510	0,245	0,146	6000
<b>407.914</b>	0,980	0,301	0,193	6000

**Deckprofile 50 mm (Masstab 1:3)**

**Profils de recouvrement 50 mm (échelle 1:3)**

**Cover sections 50 mm (scale 1:3)**

VISS Fassade

VISS façade

VISS façade

**Edelstahl-Abdeckprofile**  
**Werkstoff 1.4301 (AISI 304)**  
geschliffen, Korn 220/240,  
mit Schutzfolie

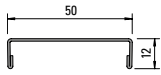

**400.860**

**Profilé de recouvrement acier Inox**  
**Qualité 1.4301 (AISI 304)**  
meulé, degré 220/240,  
avec feuille de protection

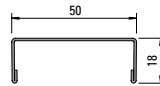

**400.861**

**Stainless steel cover sections**  
**Material 1.4301 (AISI 304)**  
polished, grain 220/240,  
with protective film



**Edelstahl-Abdeckprofile**  
**Werkstoff 1.4401 (AISI 316)**  
geschliffen, Korn 220/240,  
mit Schutzfolie

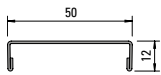

**400.862**

**Profilé de recouvrement acier Inox**  
**Qualité 1.4401 (AISI 316)**  
meulé, degré 220/240,  
avec feuille de protection

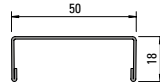

**400.863**

**Stainless steel cover sections**  
**Material 1.4401 (AISI 316)**  
polished, grain 220/240,  
with protective film



Profil-Nr.	G kg/m	L mm
<b>400.860</b>	0,644	6000
<b>400.861</b>	0,734	6000

Profil-Nr.	G kg/m	L mm
<b>400.862</b>	0,652	6000
<b>400.863</b>	0,744	6000

Artikelbibliothek  
Bibliothèque des articles  
Article library

**DXF**

**DWG**



**Deckprofile 60 mm (Masstab 1:3)**  
**Profils de recouvrement 60 mm (échelle 1:3)**  
**Cover sections 60 mm (scale 1:3)**

VISS Fassade  
 VISS façade  
 VISS façade

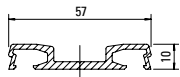

**407.802**

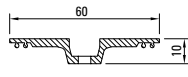

**407.822**



**407.823**

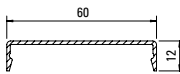

**407.865**

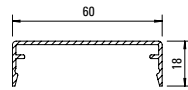

**407.866**

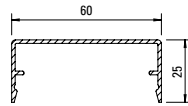

**407.867**

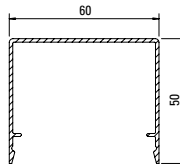

**407.868**

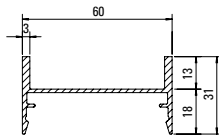

**407.901**

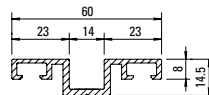

**407.859\***

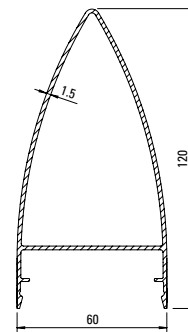

**407.915**

Profil-Nr.	G kg/m	U m <sup>2</sup> /m	P m <sup>2</sup> /m	L mm
<b>407.802</b>	0,558	0,190		6000
<b>407.822</b>	0,530	0,163	0,051	6000
<b>407.823</b>	0,076	0,043	0,019	6000
<b>407.865</b>	0,304	0,167	0,082	6000
<b>407.866</b>	0,379	0,205	0,094	6000
<b>407.867</b>	0,432	0,223	0,108	6000

Profil-Nr.	G kg/m	U m <sup>2</sup> /m	P m <sup>2</sup> /m	L mm
<b>407.868</b>	0,750	0,330	0,160	6000
<b>407.859</b>	0,643	0,233	0,097	6000
<b>407.901</b>	0,590	0,255	0,148	6000
<b>407.915</b>	1,258	0,373	0,240	6000

\* Sonderkonstruktion (nach Produktnorm EN 13830 nicht geprüft). Einsatz nur im Pfostenbereich.

\* Construction spéciale (non contrôlé selon la norme produit EN 13830). Utilisation uniquement dans la zone du montant.

\* Special construction (Not tested in accordance with the EN 13830 product standard). Only for use in mullion area.



**455.537**

**Innendichtung vertikal**  
50 mm breit, EPDM schwarz

VE = 50 m

**455.537**

**Joint intérieur vertical**  
largeur 50 mm, EPDM noir

UV = 50 m

**455.537**

**Inner gasket, vertical**  
50 mm wide, EPDM black

PU = 50 m



**455.558**

**Innendichtung horizontal**  
50 mm breit, EPDM schwarz

VE = 50 m

**455.558**

**Joint intérieur horizontal**  
largeur 50 mm, EPDM noir

UV = 50 m

**455.558**

**Inner gasket, horizontal**  
50 mm wide, EPDM black

PU = 50 m

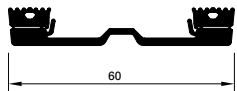

**455.538**

**Innendichtung vertikal**  
60 mm breit, EPDM schwarz

VE = 50 m

**455.538**

**Joint intérieur vertical**  
largeur 60 mm, EPDM noir

UV = 50 m

**455.538**

**Inner gasket, vertical**  
60 mm wide, EPDM black

PU = 50 m

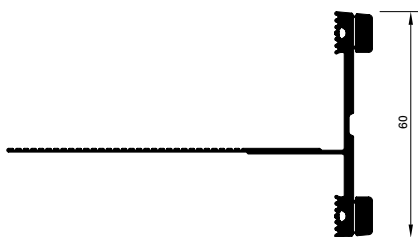

**455.559**

**Innendichtung horizontal**  
60 mm breit, EPDM schwarz

VE = 50 m

**455.559**

**Joint intérieur horizontal**  
largeur 60 mm, EPDM noir

UV = 50 m

**455.559**

**Inner gasket, horizontal**  
60 mm wide, EPDM black

PU = 50 m

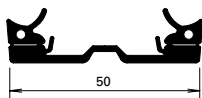

**455.545**

**Innendichtung vertikal**  
50 mm breit, für Segment-  
verglasungen, EPDM schwarz

VE = 50 m

**455.545**

**Joint intérieur vertical**  
largeur 50 mm, pour vitrage  
segmenté, EPDM noir

UV = 50 m

**455.545**

**Inner gasket, vertical**  
50 mm wide, for segmental  
glazing, EPDM black

PU = 50 m

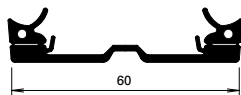

**455.546**

**Innendichtung vertikal**  
60 mm breit, für Segment-  
verglasungen, EPDM schwarz

VE = 50 m

**455.546**

**Joint intérieur vertical**  
largeur 60 mm, pour vitrage  
segmenté, EPDM noir

UV = 50 m

**455.546**

**Inner gasket, vertical**  
60 mm wide, for segmental  
glazing, EPDM black

PU = 50 m



**455.501**

**Aussendichtung**  
für Anpressprofile,  
EPDM schwarz

VE = 100 m

Einsatz:  
Pfosten, Riegel oben

**455.501**

**Joint extérieur**  
pour profilés de fixation,  
EPDM noir

UV = 100 m

Utilisation:  
Montant, traverse supérieur

**455.501**

**Outer gasket**  
for clamping sections,  
EPDM black

PU = 100 m

Application:  
Mullion, transoms top



**455.502**

**Aussendichtung**  
für Anpressprofile,  
EPDM schwarz

VE = 50 m

Einsatz:  
Riegel unten

**455.502**

**Joint extérieur**  
pour profilés de fixation,  
EPDM noir

UV = 50 m

Utilisation:  
Traverse inférieur

**455.502**

**Outer gasket**  
for clamping sections,  
EPDM black

PU = 50 m

Application:  
Transom bottom



**452.499**

**Entspannungsstück**  
Kunststoff schwarz

VE = 100 Stück

Einsatz:  
Riegel unten, als Entspannungs-  
und Entwässerungsöffnung  
(Dichtung 455.502)

**452.499**

**Pièce de décompression**  
matière plastique noire

UV = 100 pièces

Utilisation:  
Traverse inférieur,  
pour l'aération et l'écoulement  
(joint 455.502)

**452.499**

**Stress relieving block**  
plastic, black

PU = 100 pieces

Application:  
Transom bottom,  
for stress relieving and drainage  
opening (gasket 455.502)



### 455.505

**Aussendichtung**  
für Anpressprofile,  
EPDM schwarz

VE = 100 m

Einsatz:  
Pfosten bei  
Segmentverglasungen bis 15°

### 455.505

**Joint extérieur**  
pour profilés de fixation,  
EPDM noir

UV = 100 m

Utilisation:  
Montant à vitrage segmenté  
jusqu'à 15°

### 455.505

**Outer gasket**  
for clamping sections,  
EPDM black

PU = 100 m

Application:  
mullions with segmental  
glazing up to 15°



### 455.565

**Ausgleichsdichtung 2 mm**  
EPDM schwarz,  
für Innendichtungen 455.537/  
455.538/455.558/455.559

VE = 50 m

### 455.565

**Joint de compensation 2 mm**  
EPDM noir, pour joint  
intérieur 455.537/  
455.538/455.558/455.559

UV = 50 m

### 455.565

**Compensating gasket 2 mm**  
EPDM black,  
for inner gasket 455.537/  
455.538/455.558/455.559

PU = 50 m



### 455.566

**Ausgleichsdichtung 4 mm**  
EPDM schwarz,  
für Innendichtungen 455.537/  
455.538/455.558/455.559

VE = 50 m

### 455.566

**Joint de compensation 4 mm**  
EPDM noir, pour joint  
intérieur 455.537/  
455.538/455.558/455.559

UV = 50 m

### 455.566

**Compensating gasket 4 mm**  
EPDM black,  
for inner gasket 455.537/  
455.538/455.558/455.559

PU = 50 m

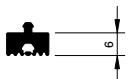

### 455.567

**Ausgleichsdichtung 6 mm**  
EPDM schwarz,  
für Innendichtungen 455.537/  
455.538/455.558/455.559

VE = 50 m

### 455.567

**Joint de compensation 6 mm**  
EPDM noir, pour joint  
intérieur 455.537/  
455.538/455.558/455.559

UV = 50 m

### 455.567

**Compensating gasket 6 mm**  
EPDM black,  
for inner gasket 455.537/  
455.538/455.558/455.559

PU = 50 m

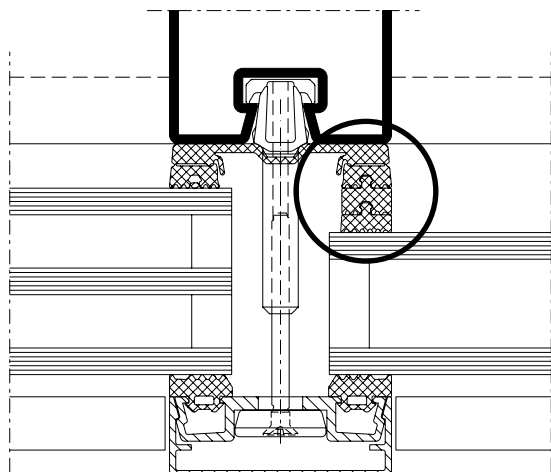

Es können maximal 2 Ausgleichsdichtungen aufgesteckt werden, wobei eine Erhöhung von 10 mm nicht überschritten werden sollte.

Il est possible d'ajouter au maximum 2 joints de compensation, sans dépasser un rehaussement de 10 mm.

A maximum of 2 compensating gaskets can be inserted, provided that the overall depth of the gasket does not exceed 10 mm.

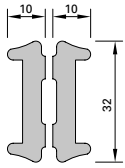

**450.065**  
**Dämmprofil Pfosten**  
aus Polyethylen-Schaum,  
für 2-fach-Isolierglas,  
Füllelement-Dicken 28-37 mm

VE = 20 m

**450.065**  
**Gaine isolante montant**  
en mousse de polyéthylène,  
pour verre isolant double,  
épaisseurs d'élément de  
remplissage 28-37 mm

UV = 20 m

**450.065**  
**Insulating core mullion**  
made from polyethylene foam,  
for double insulating glass,  
infill unit thicknesses 28-37 mm

PU = 20 m

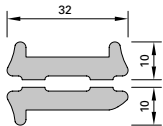

**450.066**  
**Dämmprofil Riegel**  
aus Polyethylen-Schaum,  
für 2-fach-Isolierglas,  
Füllelement-Dicken 28-37 mm

VE = 20 m

**450.066**  
**Gaine isolante traverse**  
en mousse de polyéthylène,  
pour verre isolant double,  
épaisseurs d'élément de  
remplissage 28-37 mm

UV = 20 m

**450.066**  
**Insulating core transom**  
made from polyethylene foam,  
for double insulating glass,  
infill unit thicknesses 28-37 mm

PU = 20 m

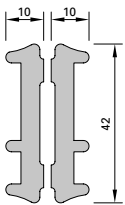

**450.067**  
**Dämmprofil Pfosten**  
aus Polyethylen-Schaum,  
für 3-fach-Isolierglas,  
Füllelement-Dicken 38-70 mm

VE = 20 m

**450.067**  
**Gaine isolante montant**  
en mousse de polyéthylène,  
pour verre isolant triple,  
épaisseurs d'élément de  
remplissage 38-70 mm

UV = 20 m

**450.067**  
**Insulating core mullion**  
made from polyethylene foam,  
for triple insulating glass,  
infill unit thicknesses 38-70 mm

PU = 20 m

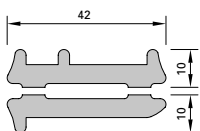

**450.068**  
**Dämmprofil Riegel**  
aus Polyethylen-Schaum,  
für 3-fach-Isolierglas,  
Füllelement-Dicken 38-70 mm

VE = 20 m

**450.068**  
**Gaine isolante transom**  
en mousse de polyéthylène,  
pour verre isolant triple,  
épaisseurs d'élément de  
remplissage 38-70 mm

UV = 20 m

**450.068**  
**Insulating core transom**  
made from polyethylene foam,  
for triple insulating glass,  
infill unit thicknesses 38-70 mm

PU = 20 m

Mit  $U_f$ -Spitzenwerten bis  $0,73 \text{ W/m}^2\text{K}$  setzt die VISS HI-Stahlfassade neue Standards in puncto Wärmedämmung und erreicht dank den innovativen Dämmprofilen Passivhaus bzw. Minergie P-Standard.

Avec des valeurs  $U_f$  maximales de  $0,73 \text{ W/m}^2\text{K}$ , la façade en acier VISS HI établit de nouveaux standards d'isolation thermique et atteint le standard P d'une maison passive et Minergie grâce aux noyaux isolants innovants.

With peak  $U_f$  values up to  $0.73 \text{ W/m}^2\text{K}$ , the VISS HI-steel facade sets new standards in heat insulation and thanks to its innovative insulating cores it reaches the standard of a passive house or the Minergie P standard.

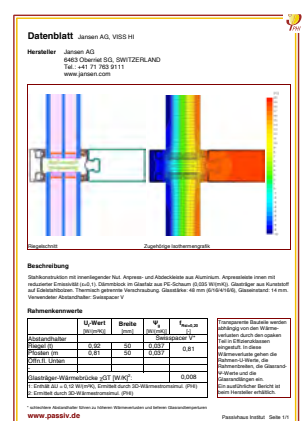
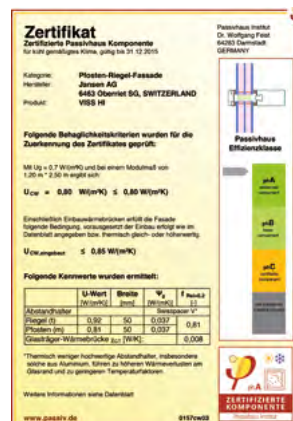

Artikel in Abhängigkeit der  
Füllelementstärken

Articles en fonction de l'éléments  
de remplissage

Items depending on thickness  
of infill elements

	Isolationsknopf Bouton d'isolation Insulating stud <b>1</b>			Traganker Boulon-support Supporting bolt <b>2</b>				Falzprofil Profilé de feuillure Rebate section <b>3</b>						Glasauflage eingeschweisst Support de verre soudé Glazing support welding <b>4</b>			Tragklotz Cale pour remplissage Glazing support <b>5</b>					
F mm	452.464	452.465	452.466	452.473	452.469	452.470	452.471	407.809	407.808	407.810	407.811	407.812	407.813	407.814	Flachstahl 100 x 10 mm Acier plat 100 x 10 mm Flat steel 100 x 10 mm	453.013	453.002	453.003	453.004	453.010	453.078	
06 – 11	●			●				●								●					●	
12 – 15	●				●				●												●	
16 – 19	●					●				●											●	
20 – 23	●					●				●							●				●	
24 – 26		●				●					●						●				●	
27 – 30		●					●					●					●				●	
31 – 35		●					●						●					●			●	
36 – 40		●					●							●					●		●	
41 – 45		●													F + 25 mm						●	
46 – 70			●																			●

- optional auch möglich
- aussi possible en option
- optional also possible

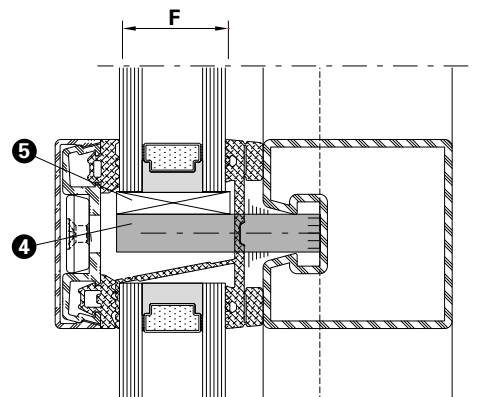
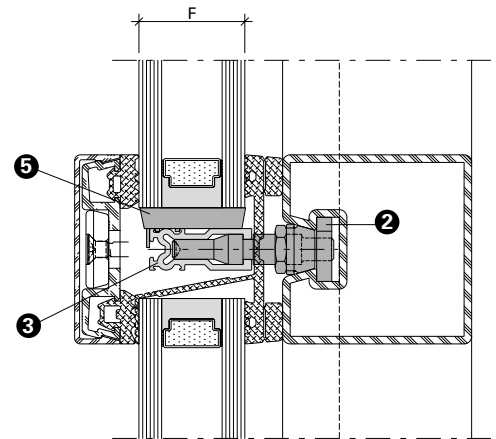
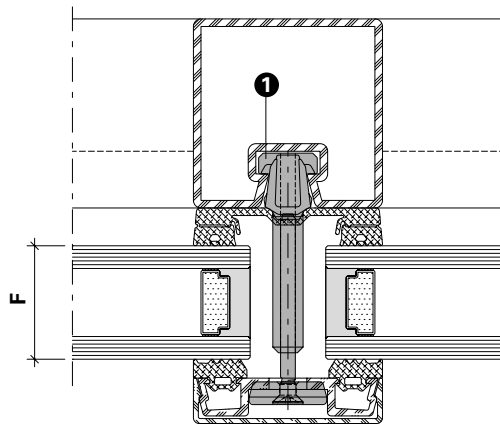
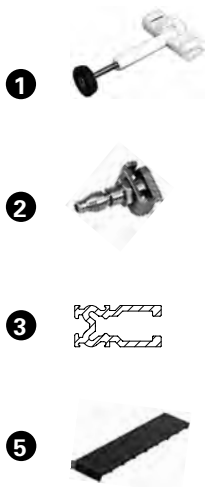

Flaches Deckprofil

Profilé de recouvrement plat

Flat cover cap

Artikel in Abhängigkeit der Füllelementstärken

Articles en fonction de l'éléments de remplissage

Items depending on thickness of infill elements

	Isolationsknopf Bouton d'isolation Insulating stud <b>1</b>			Traganker Boulon-support Supporting bolt <b>2</b>			Falzprofil Profilé de feuillure Rebate section <b>3</b>						Glasauflage eingeschweisst Support de verre soudé Glazing support welding <b>4</b>			Tragklotz* Cale pour remplissage* Glazing support* <b>5</b>
F mm	452.410	452.411	452.412	452.469	452.470	452.471	407.808	407.810	407.811	407.812	407.813	407.814	Flachstahl 100 x 10 mm Acier plat 100 x 10 mm Flat steel 100 x 10 mm	453.078		
20 – 24	●			●			●							T = F		
25 – 27	●				●			●								
28 – 31	●				●				●							
32 – 35	●					●				●						
36 – 40		●				●					●					
41 – 45		●				●						●				
46 – 55		●														
56 – 70			●										F + 16 mm			

\* Hinweis

Vordere Kante 45° zuschneiden, Mindestdicke Aussenscheibe 4 mm (auch im VSG)

\* Remarque

Couper l'arrête avant à 45°, épaisseur minimale de la vitre extérieure 4 mm (également en VSG)

\* Note

Cut front edge at 45°, minimum thickness of outer pane = 4 mm (also for LSG)

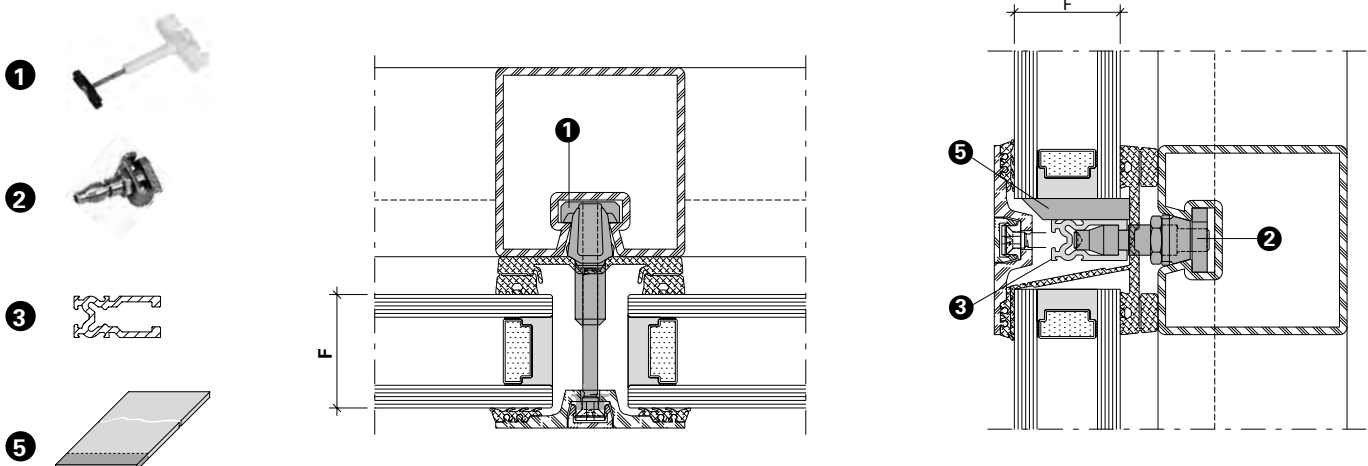



**452.464** F = 6 – 23 mm  
**452.465** F = 24 – 45 mm  
**452.466** F = 46 – 70 mm

**Isolationsknopf**  
bestehend aus vormontiertem Kunststoff-Drehknopf mit Klemmfeder und Edelstahl-Spezialschraube mit montierter Kunststoff-Zentrierscheibe.

VE = 100 Stück

Einsatz:  
siehe Seite 22-16

**452.464** F = 6 – 23 mm  
**452.465** F = 24 – 45 mm  
**452.466** F = 46 – 70 mm

**Bouton d'isolation**  
composé d'un bouton en matière plastique prémonté et d'une vis spéciale en acier Inox et une rondelle de centrage.

UV = 100 pièces

Utilisation:  
voir page 22-16

**452.464** F = 6 – 23 mm  
**452.465** F = 24 – 45 mm  
**452.466** F = 46 – 70 mm

**Insulating stud**  
comprising pre-assembled plastic turning knob with friction spring and special stainless steel screw with built-in plastic centring disc.

PU = 100 pieces

Application:  
see page 22-16



**452.473** F = 6 – 11 mm

**Traganker**  
Edelstahl 1.4305, mit vormontiertem Keil und Nutenstein, zum Abtragen der Füllelement-Gewichte.

VE = 20 Stück

Einsatz:  
siehe Seite 22-16

**452.473** F = 6 – 11 mm

**Boulon-support**  
acier Inox 1.4305, avec cale prémontée et clameau, pour supporter le poids du remplissage.

UV = 20 pièces

Utilisation:  
voir page 22-16

**452.473** F = 6 – 11 mm

**Supporting bolt**  
stainless steel 1.4305, with pre-assembled key and tenon block, to support weight of infill panel.

PU = 20 pieces

Application:  
see page 22-16



**452.469** F = 12 – 15 mm  
**452.470** F = 16 – 26 mm  
**452.471** F = 27 – 40 mm

**Traganker**  
Edelstahl 1.4305, mit vormontiertem Keil und Nutenstein, zum Abtragen der Füllelement-Gewichte.

VE = 20 Stück

Einsatz:  
siehe Seite 22-16/17

**452.469** F = 12 – 15 mm  
**452.470** F = 16 – 26 mm  
**452.471** F = 27 – 40 mm

**Boulon-support**  
acier Inox 1.4305, avec cale prémontée et clameau, pour supporter le poids du remplissage.

UV = 20 pièces

Utilisation:  
voir page 22-16/17

**452.469** F = 12 – 15 mm  
**452.470** F = 16 – 26 mm  
**452.471** F = 27 – 40 mm

**Supporting bolt**  
stainless steel 1.4305, with pre-assembled key and tenon block, to support weight of infill panel.

PU = 20 pieces

Application:  
see page 22-16/17



Flaches Deckprofil

Profilé de recouvrement plat

Flat cover cap



**452.410** F = 20 - 39 mm  
**452.411** F = 36 - 59 mm  
**452.412** F = 56 - 70 mm

**Isolationsknopf**  
bestehend aus vormontiertem Kunststoff-Drehknopf mit Klemmfeder und Edelstahl-Spezialschraube mit montiertem Kunststoff-Klemmkopf.

VE = 100 Stück

Einsatz:  
Flaches Deckprofil  
siehe Seite 22-17

**452.410** F = 20 - 39 mm  
**452.411** F = 36 - 59 mm  
**452.412** F = 56 - 70 mm

**Bouton d'isolation**  
composé d'un bouton en matière plastique prémonté et d'une vis spéciale en acier Inox avec tête de serrage en PVC montée.

UV = 100 pièces

Utilisation:  
Profilé de recouvrement plat  
voir page 22-17

**452.410** F = 20 - 39 mm  
**452.411** F = 36 - 59 mm  
**452.412** F = 56 - 70 mm

**Insulating stud**  
comprising pre-assembled plastic turning knob with friction spring and special stainless steel screw with mounted plastic clamping nut.

PU = 100 pieces

Application:  
Flat cover cap  
see page 22-17



**455.528**  
**Aussendichtung**  
**vertikal/horizontal oben**  
EPDM schwarz

VE = 100 m

Einsatz:  
Flaches Deckprofil

**455.528**  
**Joint extérieur**  
**vertical/horizontal haut**  
EPDM noir

UV = 100 m

Utilisation:  
Profilé de recouvrement plat

**455.528**  
**Outer gasket**  
**vertical/horizontal at the top**  
EPDM black

PU = 100 m

Application:  
Flat cover cap



**455.529**  
**Aussendichtung**  
**horizontal unten**  
EPDM schwarz

VE = 50 m

Einsatz:  
Flaches Deckprofil

**455.529**  
**Joint extérieur**  
**horizontal bas**  
EPDM noir

UV = 50 m

Utilisation:  
Profilé de recouvrement plat

**455.529**  
**Outer gasket**  
**horizontal at the bottom**  
EPDM black

PU = 50 m

Application:  
Flat cover cap

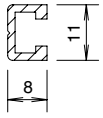

**407.809** F = 6 – 11 mm

**Falzprofil**  
Aluminium,  
für Glasauflage,  
0,113 kg/m

VE = 6 m

Einsatz:  
siehe Seite 22-16

**407.809** F = 6 – 11 mm

**Profilé de feuillure**  
aluminium,  
pour support de verre,  
0,113 kg/m

UV = 6 m

Utilisation:  
voir page 22-16

**407.809** F = 6 – 11 mm

**Rebate section**  
aluminium,  
for glazing supports,  
0,113 kg/m

PU = 6 m

Application:  
see page 22-16

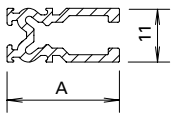

**Falzprofil**  
Aluminium,  
für Glasauflage

VE = 6 m

Artikel-Nr.	A mm	kg m	F mm
<b>407.808</b>	18	0,187	12-15
<b>407.810</b>	20	0,230	16-23
<b>407.811</b>	23	0,275	24-26
<b>407.812</b>	27	0,305	27-30
<b>407.813</b>	31	0,338	31-35
<b>407.814</b>	36	0,374	36-40

Einsatz:  
siehe Seite 22-16/17

**Profilé de feuillure**  
aluminium,  
pour support de verre

UV = 6 m

No d'article	A mm	kg m	F mm
<b>407.808</b>	18	0,187	12-15
<b>407.810</b>	20	0,230	16-23
<b>407.811</b>	23	0,275	24-26
<b>407.812</b>	27	0,305	27-30
<b>407.813</b>	31	0,338	31-35
<b>407.814</b>	36	0,374	36-40

Utilisation:  
voir page 22-16/17

**Rebate section**  
aluminium,  
for glazing supports

PU = 6 m

Code no.	A mm	kg m	F mm
<b>407.808</b>	18	0,187	12-15
<b>407.810</b>	20	0,230	16-23
<b>407.811</b>	23	0,275	24-26
<b>407.812</b>	27	0,305	27-30
<b>407.813</b>	31	0,338	31-35
<b>407.814</b>	36	0,374	36-40

Application:  
see page 22-16/17

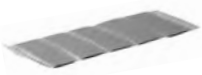

**455.423** 50 mm  
**455.424** 60 mm

**Butyl-Dichtstück**  
zum Abdichten der Kreuz- und  
Endpunkte der Innendichtungen.

VE = 50 Stück

**455.423** 50 mm  
**455.424** 60 mm

**Pièce de butyl**  
pour étancher les points de  
croisée et les points T des joints  
intérieurs.

UV = 50 pièces

**455.423** 50 mm  
**455.424** 60 mm

**Butyl sealing strip**  
for sealing the intersecting and  
end points of the inner gaskets.

PU = 50 pieces

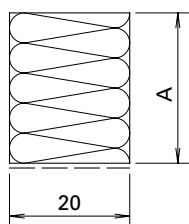

**Ausgleichsprofil für  
Wandanschluss**  
aus Polystyrol-Hartschaum,  
einseitig mit Kleber und  
Schutzfolie.

VE = 20 Stück à 1250 mm

**Profils de compensation**  
en mousse rigide de  
polystyrène, une face adhésive  
avec feuille de protection

UV = 20 pièces à 1250 mm

**Compensating section for  
wall abutment**  
rigid expanded polystyrene,  
with adhesive and protective  
film on one side

PU = 20 pieces, 1250 mm each

Artikel-Nr.	A mm
<b>452.310</b>	10
<b>452.311</b>	20
<b>452.312</b>	22
<b>452.313</b>	24
<b>452.314</b>	26
<b>452.315</b>	28
<b>452.316</b>	30

No d'article	A mm
<b>452.310</b>	10
<b>452.311</b>	20
<b>452.312</b>	22
<b>452.313</b>	24
<b>452.314</b>	26
<b>452.315</b>	28
<b>452.316</b>	30

Code no.	A mm
<b>452.310</b>	10
<b>452.311</b>	20
<b>452.312</b>	22
<b>452.313</b>	24
<b>452.314</b>	26
<b>452.315</b>	28
<b>452.316</b>	30



**453.013** F = 6 - 11 mm

**Tragklotz**  
PE schwarz, 80/8/6,  
selbstklebend

VE = 50 Stück

Einsatz:  
siehe Seite 22-16

**453.013** F = 6 - 11 mm

**Cale pour remplissage**  
PE noir, 80/8/6,  
autocollante

UV = 50 pièces

Utilisation:  
voir page 22-16

**453.013** F = 6 - 11 mm

**Glazing support**  
PE black, 80/8/6,  
self adhesive

PU = 50 pieces

Application:  
see page 22-16



**453.002** F = 20 - 26 mm

**453.003** F = 27 - 30 mm

**453.004** F = 31 - 35 mm

**453.010** F = 36 - 40 mm

**Tragklotz**  
GFK-PA schwarz

VE = 50 Stück

Einsatz:  
siehe Seite 22-16

**453.002** F = 20 - 26 mm

**453.003** F = 27 - 30 mm

**453.004** F = 31 - 35 mm

**453.010** F = 36 - 40 mm

**Cale pour remplissage**  
GFK-PA noir

UV = 50 pièces

Utilisation:  
voir page 22-16

**453.002** F = 20 - 26 mm

**453.003** F = 27 - 30 mm

**453.004** F = 31 - 35 mm

**453.010** F = 36 - 40 mm

**Glazing support**  
GFK-PA black

PU = 50 pieces

Application:  
see page 22-16

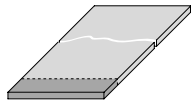

**453.078**

**Tragklotz**  
PE schwarz, 80 x 6 mm,  
zum selber Zuschneiden

VE = 1 Stück à 1000 mm

Einsatz:  
siehe Seite 22-16/17

**453.078**

**Cale pour remplissage**  
PE noir, 80 x 6 mm,  
à découper soi-même

UV = 1 pièce à 1000 mm

Utilisation:  
voir page 22-16/17

**453.078**

**Glazing support**  
PE black, 80 x 6 mm  
to be cut by customer

PU = 1 piece, 1000 mm each

Application:  
see page 22-16/17

Sonderkonstruktion mit sichtbar  
verschraubter Deckleiste

Construction spéciale avec profilé  
de recouvrement vissé visible

Special construction using a  
visible screw-affixed cover section



**452.467**

**Klemm-Isolationsknopf**

bestehend aus vormontiertem  
Kunststoff-Drehknopf mit Edel-  
stahlknopf und Klemmfeder

VE = 50 Stück

**452.467**

**Bouton-pression d'isolation**

composé d'un bouton matière  
plastique prémonté avec tête en  
acier Inox et ressort de serrage.

UV = 50 pièces

**452.467**

**Insulating coupling stud**

comprising plastic turning knob  
with stainless steel button and  
clamp spring

PU = 50 pieces



**452.497**

**Edelstahl-SR1-Selbst-  
bohr-schraube ø 3,9 x 25,5 mm**  
für Abdeckprofile 407.815,  
407.858 und 407.859

VE = 100 Stück

**452.497**

**Vis autoforeuse acier Inox SR1**  
ø 3,9 x 25,5 mm  
pour profilés de recouvrement  
407.815, 407.858 et 407.859

UV = 100 pièces

**452.497**

**Stainless steel SR1 self-cutting  
screw ø 3,9 x 25,5 mm**  
for cover sections 407.815,  
407.858 and 407.859

PU = 100 pieces



**452.495**

**Edelstahl-SR1-Selbst-  
bohr-schraube ø 3,9 x 31,5 mm**  
für Abdeckprofile 407.858  
und 407.859

VE = 100 Stück

**452.495**

**Vis autoforeuse acier Inox-SR1**  
ø 3,9 x 31,5 mm  
pour profilés de recouvrement  
407.858 et 407.859

UV = 100 pièces

**452.495**

**Stainless steel SR1 self-cutting  
screw ø 3,9 x 31,5 mm**  
for cover sections 407.858 and  
407.859

PU = 100 pieces



**550.378**

**Edelstahl-Selbstbohrschraube**  
4,8x29 mm, mit Innen-Sechs-  
kant, für Abdeckprofile 407.817  
und 407.818

VE = 100 Stück

**550.378**

**Vis autoforeuse acier Inox**  
4,8x29 mm, avec six pans creux,  
pour profilés de recouvrement  
407.817 et 407.818

UV = 100 pièces

**550.378**

**Stainless steel self-cutting  
screw**  
4,8x29 mm, hexagon socket  
head, for cover sections 407.817  
and 407.818

PU = 100 pieces



**Ankerteil für  
Sonnenschutz-Befestigung**  
Edelstahl, mit vormontiertem  
Aluminium-Keil und Nutenstein

VE = 10 Stück

Artikel-Nr.	Länge
<b>452.550</b>	9 mm
<b>452.551</b>	17 mm
<b>452.552</b>	23 mm
<b>452.553</b>	30 mm
<b>452.554</b>	35 mm
<b>452.555</b>	42 mm
<b>452.556</b>	55 mm

Einsatz:  
siehe Seiten 22-72/73

**Boulon d'ancrage  
pour fixation pare-soleil**  
acier Inox, avec cale prémontée  
en aluminium et clameau

UV = 10 pièces

No d'article	Longuer
<b>452.550</b>	9 mm
<b>452.551</b>	17 mm
<b>452.552</b>	23 mm
<b>452.553</b>	30 mm
<b>452.554</b>	35 mm
<b>452.555</b>	42 mm
<b>452.556</b>	55 mm

Utilisation:  
voir pages 22-72/73

**Anchor for fastening  
of sun protection**  
stainless steel, with pre-  
assembled aluminium key and  
tenon block

PU = 10 pieces

Code no.	Length
<b>452.550</b>	9 mm
<b>452.551</b>	17 mm
<b>452.552</b>	23 mm
<b>452.553</b>	30 mm
<b>452.554</b>	35 mm
<b>452.555</b>	42 mm
<b>452.556</b>	55 mm

Application:  
see pages 22-72/73



**452.557**  
**Aufsatzbolzen für  
Sonnenschutz-Befestigung**  
Edelstahl, mit vormontier-  
tem M4-Gewindestift und  
EPDM-Dichtscheibe, zum Auf-  
setzen auf Befestigungsanker  
452.550-452.556.

VE = 10 Stück

Einsatz:  
siehe Seiten 22-72/73

**452.557**  
**Boulon de fixation pour  
fixation pare-soleil**  
acier Inox, avec taraudage M4  
et rondelle d'étanchéité EPDM,  
à poser sur boulon d'ancrage  
452.550-452.556.

UV = 10 pièces

Utilisation:  
voir pages 22-72/73

**452.557**  
**Bolt for fastening  
of sun protection**  
stainless steel, with pre-  
assembled M4 threaded pin  
and EPDM seal washer, to  
be fitted onto fastening  
anchor 452.550-452.556.

PU = 10 pieces

Application:  
see pages 22-72/73



### 450.092

#### Kleb- und Dichtmasse

schwarz, für das Abdichten der Dichtungs-Stösse und -Durchbrüche

VE = 1 Kartusche 290 ml

#### Wichtig:

**Ohne Vorbehandlung mit Reiniger 450.091 ist die Klebehaftung nicht gewährleistet.**

### 450.092

#### Pâte à coller et à étancher

noire, pour étancher les raccords et les points de raccords des joints intérieurs

UV = 1 cartouche 290 ml

#### Important:

**Sans traitement préliminaire avec un nettoyant 450.091, l'adhésion n'est pas garantie.**

### 450.092

#### Sealing and bonding compound

black, for sealing the joints and holes in the weatherstrip

PU = 1 cartridge 290 ml

#### Important:

**Adhesion cannot be guaranteed unless cleaner 450.091 has been used as a pre-treatment.**



### 450.091

#### Reiniger

zur Reinigung aller Teile vor dem Anbringen der Dichtmasse

VE = 1 Liter

### 450.091

#### Nettoyant

pour nettoyer toutes les pièces avant d'appliquer la pâte à étancher

UV = 1 litre

### 450.091

#### Cleaner

for cleaning all components before applying the sealing compound

PU = 1 litre



### 450.106

#### Dichtmasse

transparent, Silikon dünnflüssig, für Abdichtungen von kleinen Fugen, inkl. Ausspritzdüsen

VE = 2 Kartuschen 310 ml

### 450.106

#### Pâte d'étanchéité

transparente, silicone fluide, pour étanchéification de petits joints, avec gicleurs d'éjection

UV = 2 cartouches de 310 ml

### 450.106

#### Sealing compound

transparent, thin silicone, for sealing small joints, includes spray nozzles

PU = 2 cartridges 310 ml



**455.495** 40 x 0,8 mm

**455.496** 50 x 0,8 mm

#### Butyl-Dichtband, alukaschiert

flexibel, dampfdicht, selbstklebend

VE = 2 Rollen à 20 m

**455.495** 40 x 0,8 mm

**455.496** 50 x 0,8 mm

#### Bande butyl, doublée d'aluminium

autocollante, flexible, étanche à la vapeur

UV = 2 rouleaux à 20 m

**455.495** 40 x 0,8 mm

**455.496** 50 x 0,8 mm

#### Butyl sealing strip, aluminium-laminated

flexible, damp-proof, self adhesive

PU = 2 rollers 20 m each

**Dichtungen VISS TV  
(Variante)**

**Joints VISS TV  
(Variante)**

**Gaskets VISS TV  
(Variante)**



**455.513**

**Innendichtung vertikal**  
50 mm breit, EPDM schwarz

VE = 50 m

**455.513**

**Joint intérieur vertical**  
largeur 50 mm, EPDM noir

UV = 50 m

**455.513**

**Inner gasket, vertical**  
50 mm wide, EPDM black

PU = 50 m

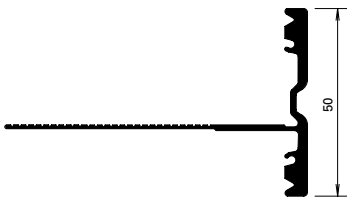

**455.555**

**Innendichtung horizontal**  
50 mm breit, EPDM schwarz

VE = 50 m

**455.555**

**Joint intérieur horizontal**  
largeur 50 mm, EPDM noir

UV = 50 m

**455.555**

**Inner gasket, horizontal**  
50 mm wide, EPDM black

PU = 50 m

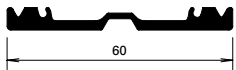

**455.514**

**Innendichtung vertikal**  
60 mm breit, EPDM schwarz

VE = 50 m

**455.514**

**Joint intérieur vertical**  
largeur 60 mm, EPDM noir

UV = 50 m

**455.514**

**Inner gasket, vertical**  
60 mm wide, EPDM black

PU = 50 m

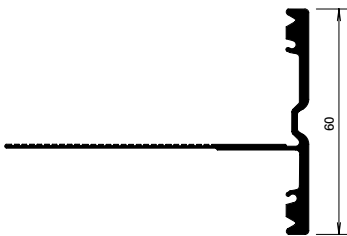

**455.556**

**Innendichtung horizontal**  
60 mm breit, EPDM schwarz

VE = 50 m

**455.556**

**Joint intérieur horizontal**  
largeur 60 mm, EPDM noir

UV = 50 m

**455.556**

**Inner gasket, horizontal**  
60 mm wide, EPDM black

PU = 50 m



**Dichtungen VISS TV  
(Variante)**

**Joints VISS TV  
(Variante)**

**Gaskets VISS TV  
(Variante)**



**455.501**

**Aussendichtung**  
für Anpressprofile,  
EPDM schwarz

VE = 100 m

Einsatz:  
Pfosten, Riegel oben

**455.501**

**Joint extérieur**  
pour profilé de fixation,  
EPDM noir

UV = 100 m

Utilisation:  
Montant, traverse supérieur

**455.501**

**Outer gasket**  
for clamping sections,  
EPDM black

PU = 100 m

Application:  
Mullion, transom top



**455.502**

**Aussendichtung**  
für Anpressprofile,  
EPDM schwarz

VE = 50 m

Einsatz:  
Riegel unten

**455.502**

**Joint extérieur**  
pour profilé de fixation,  
EPDM noir

UV = 50 m

Utilisation:  
Traverse inférieur

**455.502**

**Outer gasket**  
for clamping sections,  
EPDM black

PU = 50 m

Application:  
Transom bottom



**452.499**

**Entspannungsstück**  
Kunststoff schwarz

VE = 100 Stück

Einsatz:  
Riegel unten, als Entspannungs-  
und Entwässerungsöffnung  
(Dichtung 455.502)

**452.499**

**Pièce de décompression**  
matière plastique noire

UV = 100 pièces

Utilisation:  
Traverse inférieure,  
pour l'aération et l'écoulement  
(joint 455.502)

**452.499**

**Stress relieving block**  
plastic, black

PU = 100 pieces

Application:  
Transom bottom,  
for stress relieving and drainage  
opening (gasket 455.502)

### Dichtungen VISS TV (Variante)

### Joints VISS TV (Variante)

### Gaskets VISS TV (Variante)

Artikel in Abhängigkeit der  
Füllelementstärken

Articles en fonction de l'éléments  
de remplissage

Items depending on thickness  
of infill elements

	Isolationsknopf Bouton d'isolation Insulating stud <b>1</b>			Traganker Boulon-support Supporting bolt <b>2</b>				Falzprofil Profilé de feuillure Rebate section <b>3</b>					Glasauflage eingeschweisst Support de verre soudé Glazing support welding	Tragklotz Cale pour remplissage Glazing support <b>4</b>						
F mm	452.464	452.465	452.466	452.473	452.469	452.470	452.471	407.809	407.808	407.810	407.811	407.812	407.813	Flachstahl 100 x 10 mm Acier plat 100 x 10 mm Flat steel 100 x 10 mm	453.013	453.002	453.003	453.004	453.010	453.078
06 – 12	●			●				●							●					●
13 – 14	●			●				●												●
15 – 19	●				●				●											●
20 – 26	●					●				●						●				●
27 – 30		●				●					●						●			●
31 – 35		●					●					●					●			●
36 – 40		●					●						●					●		●
41 – 50		●												F + 21 mm						●
51 – 70			●																	

- optional auch möglich
- aussi possible en option
- optional also possible

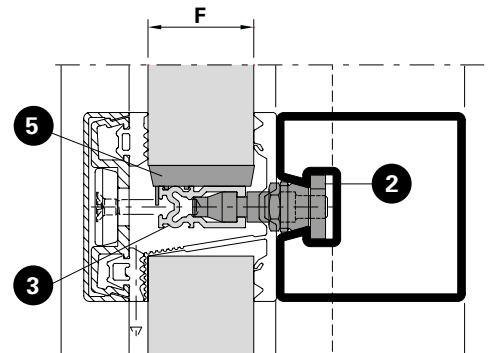
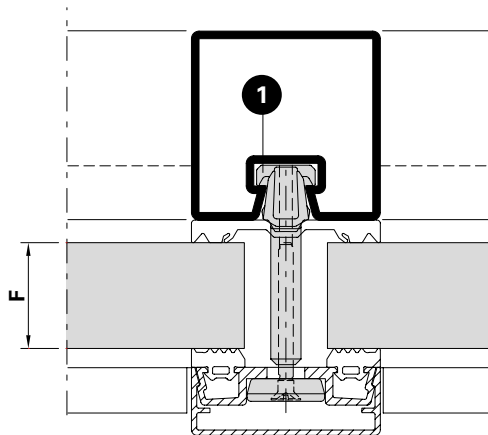
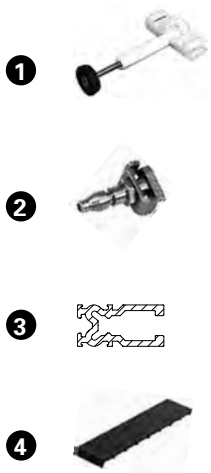

## Dichtungen VISS TV (Variante)

Flaches Deckprofil

Artikel in Abhängigkeit der  
Füllelementstärken

## Jointes VISS TV (Variante)

Profilé de recouvrement plat

Articles en fonction de l'éléments  
de remplissage

## Gaskets VISS TV (Variante)

Flat cover cap

Items depending on thickness  
of infill elements

	Isolationsknopf Bouton d'isolation Insulating stud			Traganker Boulon-support Supporting bolt			Falzprofil Profilé de feuillure Rebate section					Glasauflage eingeschweisst Support de verre soudé Glazing support welding	Tragklotz* Cale pour remplissage* Glazing support*	
	①			②			③							④
F mm	452.410	452.411	452.412	452.469	452.470	452.471	407.808	407.810	407.811	407.812	407.813	407.814	Flachstahl 100 x 10 mm Acier plat 100 x 10 mm Flat steel 100 x 10 mm	453.078
25 – 28	●			●			●						T = F	
29 – 31	●				●			●						
32 – 35	●				●				●					
36 – 39	●					●				●				
40 – 44		●				●					●			
45 – 49		●				●						●		
50 – 59		●												
60 – 70			●										F + 12 mm	

### \* Hinweis

Vordere Kante 45° zuschneiden,  
Mindestdicke Aussenscheibe 4 mm  
(auch im VSG)

### \* Remarque

Couper l'arrête avant à 45°, épaisseur  
minimale de la vitre extérieure 4 mm  
(également en VSG)

### \* Note

Cut front edge at 45°, minimum  
thickness of outer pane = 4 mm  
(also for LSG)

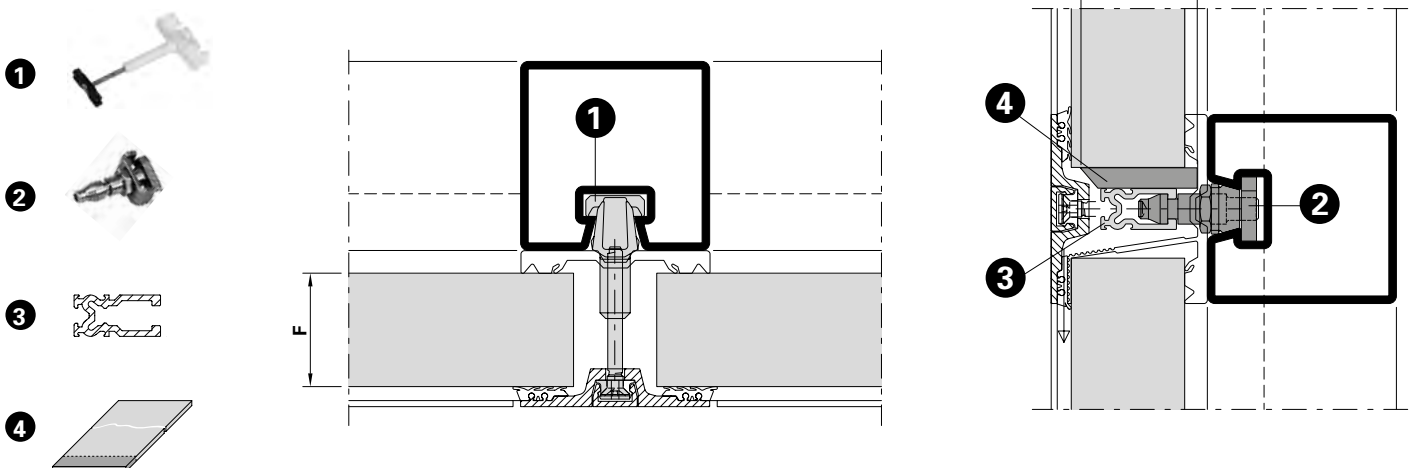



**499.003**  
**Schraubklingen**  
mit SR1-Angriff

VE = 3 Stück

**499.003**  
**Embout de tournevis**  
avec tête spéciale SR1

UV = 3 pièces

**499.003**  
**Blades**  
for SR1-head screws

PU = 3 pieces



**499.254**  
**Werkzeugset**

VE = 1 Steckschlüssel SW 11  
1 Positionierhilfe 25 mm  
1 Positionierhilfe 32 mm

**499.254**  
**Jeu d'outils**

UV = 1 clé à pipe SW 11  
1 aide de réglage 25 mm  
1 aide de réglage 32 mm

**499.254**  
**Tool kit**

PU = 1 box spanner size 11  
1 positioning aid 25 mm  
1 positioning aid 32 mm



**499.206**  
**Abziehhebel**  
für die Demontage der  
aufgeklipsten Abdeckprofile

VE = 1 Stück

**499.206**  
**Levier de démontage**  
pour le démontage des profilés  
de recouvrement clipsés

UV = 1 pièce

**499.206**  
**Stripping lever**  
for disassembly of the clipped  
on cover profile

PU = 1 piece



**499.263**  
**Dichtungsschere Kreuzpunkt**  
zum Ausklinken der vertikalen  
Innendichtung

VE = 1 Stück

**499.263**  
**Ciseaux à joints point  
d'intersection**  
pour entailler le joint intérieur  
vertical

UV = 1 pièce

**499.263**  
**Gasket shears for the  
intersection point**  
for notching the vertical  
inner gasket

UV = 1 piece

Verlangen Sie für die  
Verarbeitung und Montage  
der VISS-Systeme unsere  
ausführlichen Verarbeitungs-  
und Montage-Richtlinien.

Demandez notre brochure  
détaillée sur les directives  
d'usinage et de montage  
du systèmes VISS.

For processing and assembling  
the VISS systems, ask for our  
detailed Fabrication and  
Assembly Instructions.



**499.264**

**Dichtungsschere Endpunkt**  
zum Ausklinken der horizontalen  
Innendichtung

VE = 1 Stück

**499.264**

**Ciseaux à joints extrémité**  
pour entailler le joint intérieur  
horizontal

UV = 1 pièce

**499.264**

**Gasket shears for the end point**  
for notching the horizontal inner  
gasket

PU = 1 piece



**499.266**

**Dichtungsstanze**  
zum Ausklinken der  
horizontalen Innendichtung

VE = 1 Stück

**499.266**

**Poinçon à joints**  
pour entailler le joint intérieur  
horizontal

UV = 1 pièce

**499.266**

**Gasket punch**  
for notching the horizontal  
inner gasket

PU = 1 piece



**499.267**

**Austauschset**  
Das Austauschset ermöglicht das  
Aufrüsten der alten Dichtungs-  
stanze 499.253 auf den Stand der  
neuen Dichtungsstanze 499.266.  
Die Adaption beinhaltet einen  
Auswurfmechanismus für die  
Dichtung sowie einen Schnittschutz.

VE = 1 Stück

**499.267**

**Kit de remplacement**  
Le kit de remplacement permet  
de remplacer l'ancien poinçon  
à joints 499.253 par le nouveau  
poinçon à joints 499.266. L'adap-  
tation comprend un mécanisme  
d'éjection du joint ainsi qu'une  
protection anticoupures.

UV = 1 pièce

**499.267**

**Replacement kit**  
The replacement kit allows the  
old gasket punch 499.253 to be  
upgraded to the standard of the  
new gasket punch 499.266. The  
adaptation includes an ejection  
mechanism for the gasket and  
cut protection.

PU = 1 piece



**499.262**

**Ausstanzset**  
zum Ausklinken der horizontalen  
Innendichtung für Flachstahl-  
Glasauflagen.

VE = 1 Stück

**499.262**

**Kit de découpage**  
pour entailler le joint intérieur  
horizontal des supports de  
vitrage en acier plat.

UV = 1 pièce

**499.262**

**Punching kit**  
for notching the horizontal  
inner gasket for flat steel  
glazing supports.

PU = 1 piece

<b>Schnittpunkte</b>	<b>Coupe de détails</b>	<b>Section details</b>	
Pfosten/Riegel-Details 50 mm	Détails montant/traverse 50 mm	Details mullion/transom 50 mm	<b>34</b>
Segment-Verglasung 50 mm	Vitrage segmenté 50 mm	Segmental glazing 50 mm	<b>39</b>
VISS Linea 50 mm	VISS Linea 50 mm	VISS Linea 50 mm	<b>40</b>
Flaches Deckprofil 50 mm	Profilé de recouvrement plat 50 mm	Flat cover cap 50 mm	<b>42</b>
VISS Linea 50 mm	VISS Linea 50 mm	VISS Linea 50 mm	<b>43</b>
Einfachverglasung 50 mm	Vitrage simple 50 mm	Single glazing 50 mm	<b>44</b>
Pfosten/Riegel-Details 60 mm	Détails montant/traverse 60 mm	Details mullion/transom 60 mm	<b>45</b>
VISS Delta 60 mm	VISS Delta 60 mm	VISS Delta 60 mm	<b>49</b>
Segment-Verglasung 60 mm	Vitrage segmenté 60 mm	Segmental glazing 60 mm	<b>51</b>
Flaches Deckprofil 60 mm	Profilé de recouvrement plat 60 mm	Flat cover cap 60 mm	<b>52</b>
Einfachverglasung 60 mm	Vitrage simple 60 mm	Single glazing 60 mm	<b>53</b>

<b>Konstruktions-Details</b>	<b>Détails de constructions</b>	<b>Construction details</b>	
Einsatzelement Janisol HI	Elément de remplissage Janisol HI	Infill element Janisol HI	<b>54</b>
Einsatzelement Janisol-Türe	Elément de remplissage porte Janisol	Infill element Janisol door	<b>55</b>
Einsatzelement Janisol Primo	Elément de remplissage Janisol Primo	Infill element Janisol Primo	<b>56</b>
Aussenecke 90°	Angle extérieur 90°	Outer corner 90°	<b>57</b>
Aussenecke 135°	Angle extérieur 135°	Outer corner 135°	<b>59</b>
Innenecke 135°	Angle intérieur 135°	Inner corner 135°	<b>60</b>
<b>Anschlüsse am Bau</b>			<b>61</b>
	<b>Raccords au mur</b>	<b>Attachment to structure</b>	
<b>Verarbeitungs-Hinweise</b>			
	<b>Indications d'usage</b>	<b>Assembly instructions</b>	
Sonnenschutz-Befestigung	Fixation pare-soleil	Sun protection fixation	<b>70</b>
Stossausbildungen Innendichtung	Jonctions joint intérieur	Inner gasket junctions	<b>72</b>
Glaseinstand	Prise en feuillure	Glass edge cover	<b>74</b>
<b>System-Hinweise</b>			
	<b>Indications du système</b>	<b>System instructions</b>	
Glasfalz-Belüftung und Glasfalz-Entwässerung	Ventilation de feuillures de verre et Drainage de la feuillure à verre	Glazing rebate ventilation and Glazing rebate drainage	<b>76</b>
U <sub>f</sub> -Werte nach EN 10077-2	Valeurs U <sub>f</sub> selon EN 10077-2	U <sub>f</sub> values according to EN 10077-2	<b>78</b>

Schnittpunkte im Massstab 1:1  
Coupe de détails à l'échelle 1:1  
Section details on scale 1:1

VISS Fassade  
VISS façade  
VISS façade

VISS HI  
Pfosten-Detail  
Ansichtsbreite 50 mm

VISS HI  
Détail du montant  
Largeur de face 50 mm

VISS HI  
Detail of mullion  
Width 50 mm

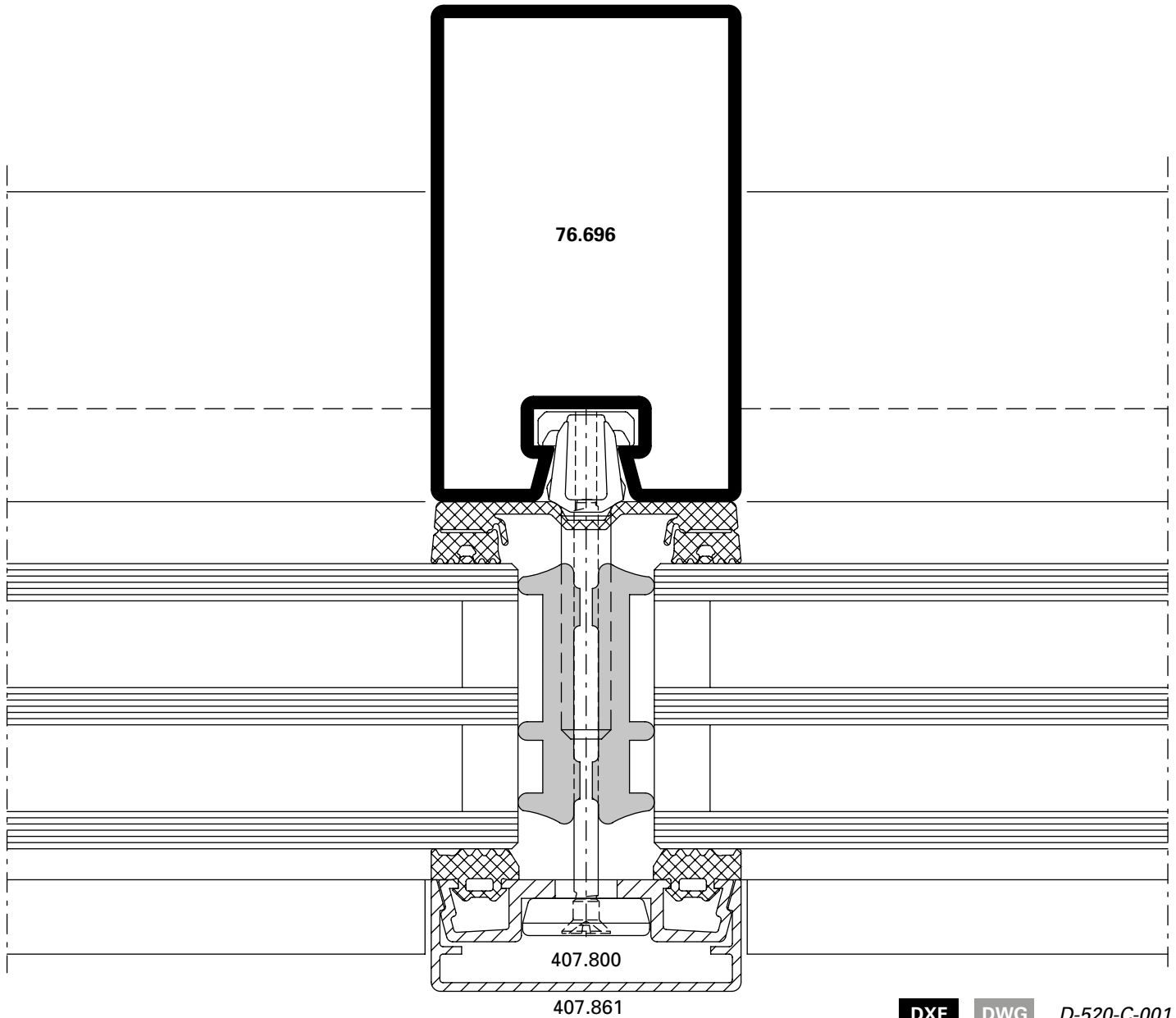

**DXF** **DWG** D-520-C-001

U<sub>f</sub>-Werte siehe ab Seite 22-78

Valeurs U<sub>f</sub> voir à partir de page 22-78

U<sub>f</sub> values see from page 22-78



Schnittpunkte im Masstab 1:1  
Coupe de détails à l'échelle 1:1  
Section details on scale 1:1

VISS Fassade  
VISS façade  
VISS façade

VISS HI  
Riegel-Detail  
Ansichtsbreite 50 mm

VISS HI  
Détail de la traverse  
Largeur de face 50 mm

VISS HI  
Detail of transom  
Width 50 mm

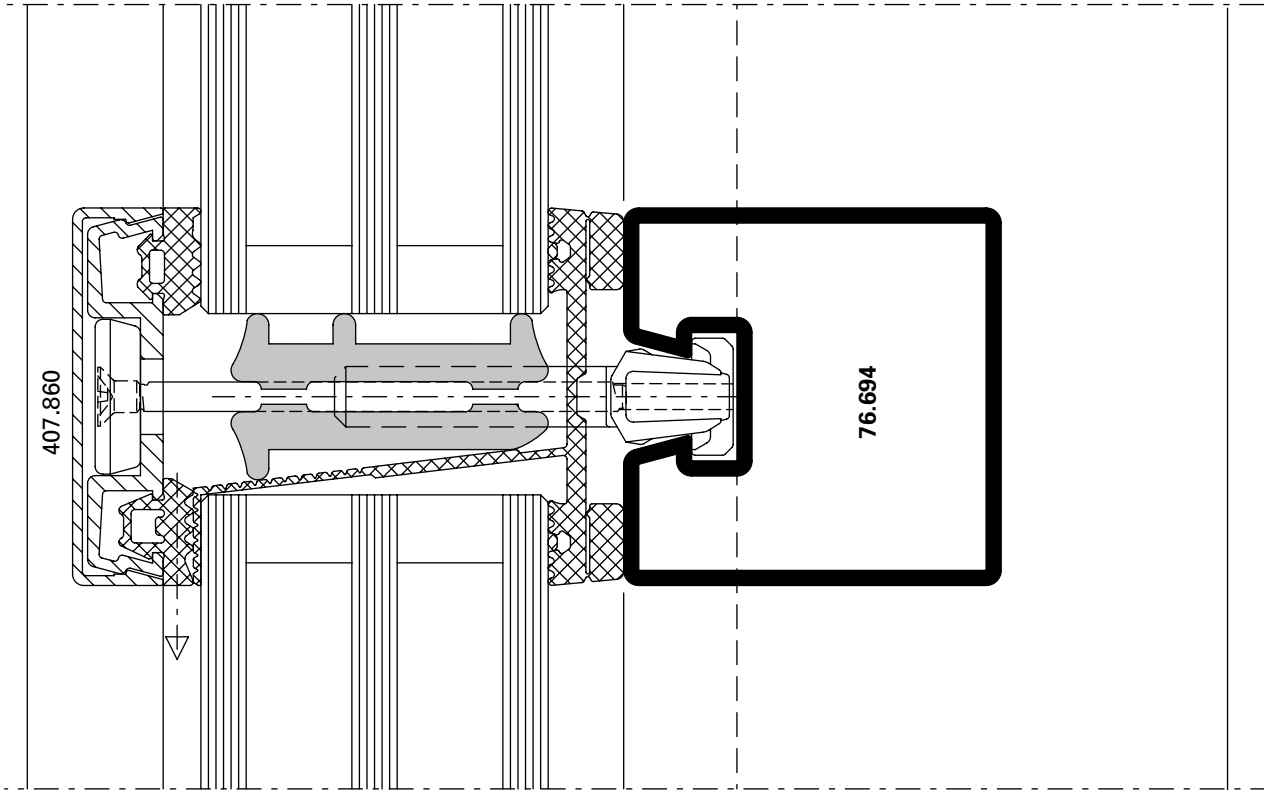

D-520-C-002

DWG

DXF

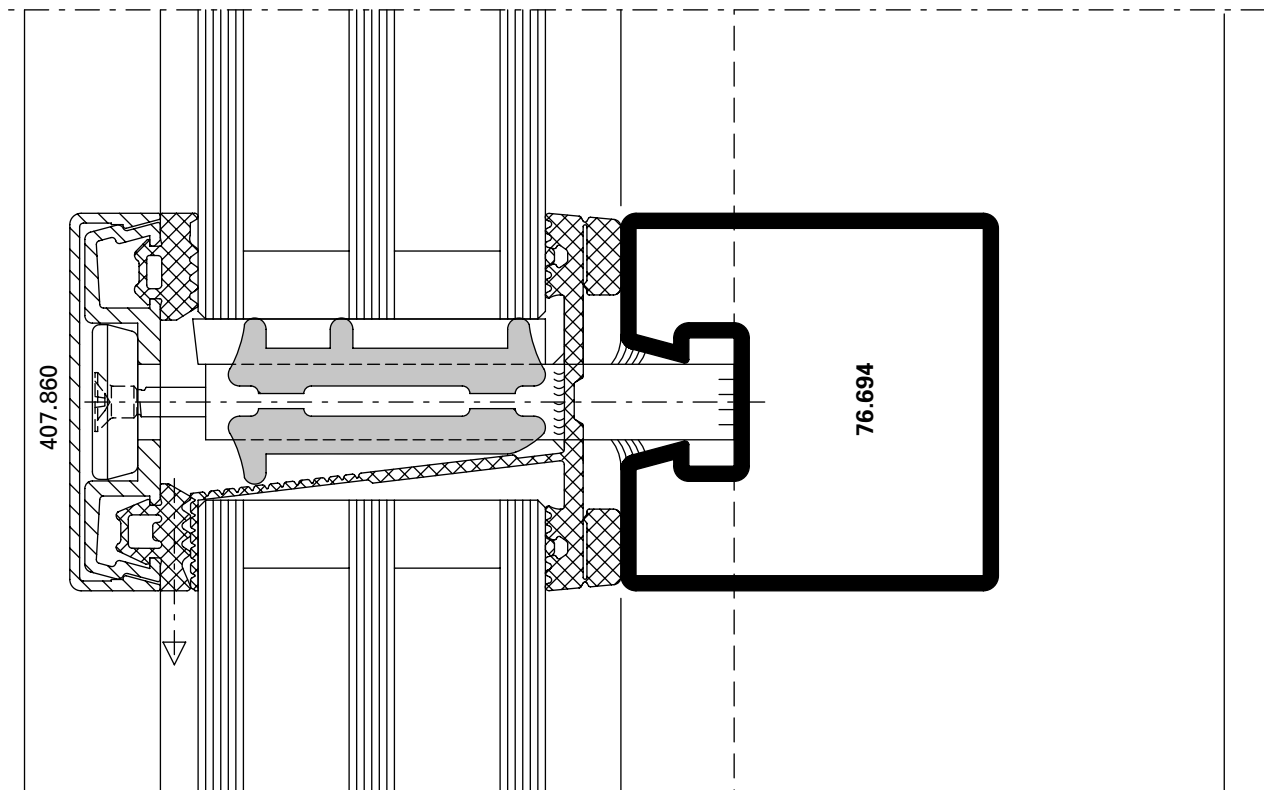

D-520-C-003

DWG

DXF

Schnittpunkte im Massstab 1:1  
Coupe de détails à l'échelle 1:1  
Section details on scale 1:1

VISS Fassade  
VISS façade  
VISS façade

Pfosten-Detail  
Ansichtsbreite 50 mm

Détail du montant  
Largeur de face 50 mm

Detail of mullion  
Width 50 mm

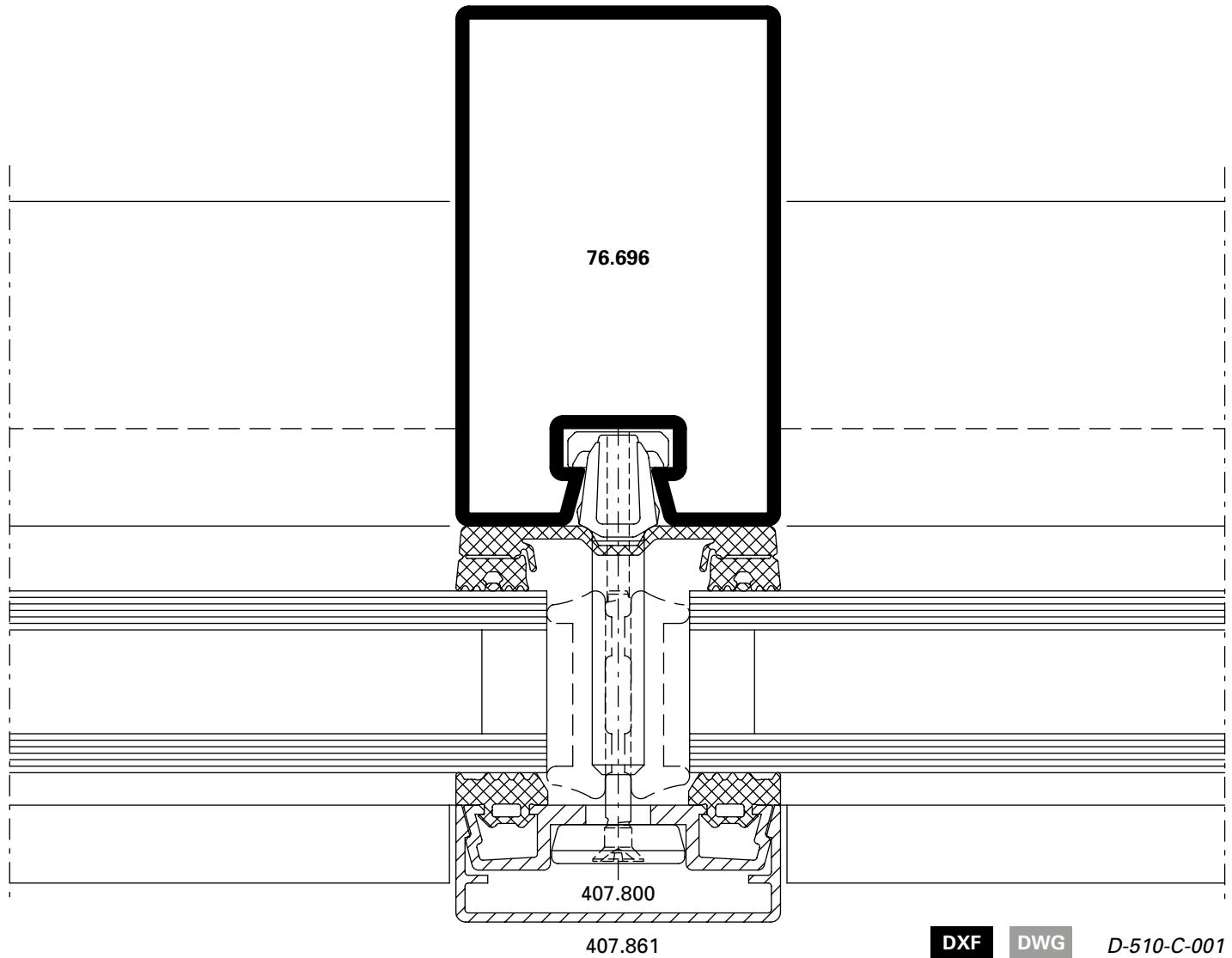

DXF

DWG

D-510-C-001

U<sub>f</sub>-Werte siehe ab Seite 22-78

Valeurs U<sub>f</sub> voir à partir de page 22-78

U<sub>f</sub> values see from page 22-78

Riegel-Detail  
Ansichtsbreite 50 mm

Détail de la traverse  
Largeur de face 50 mm

Detail of transom  
Width 50 mm

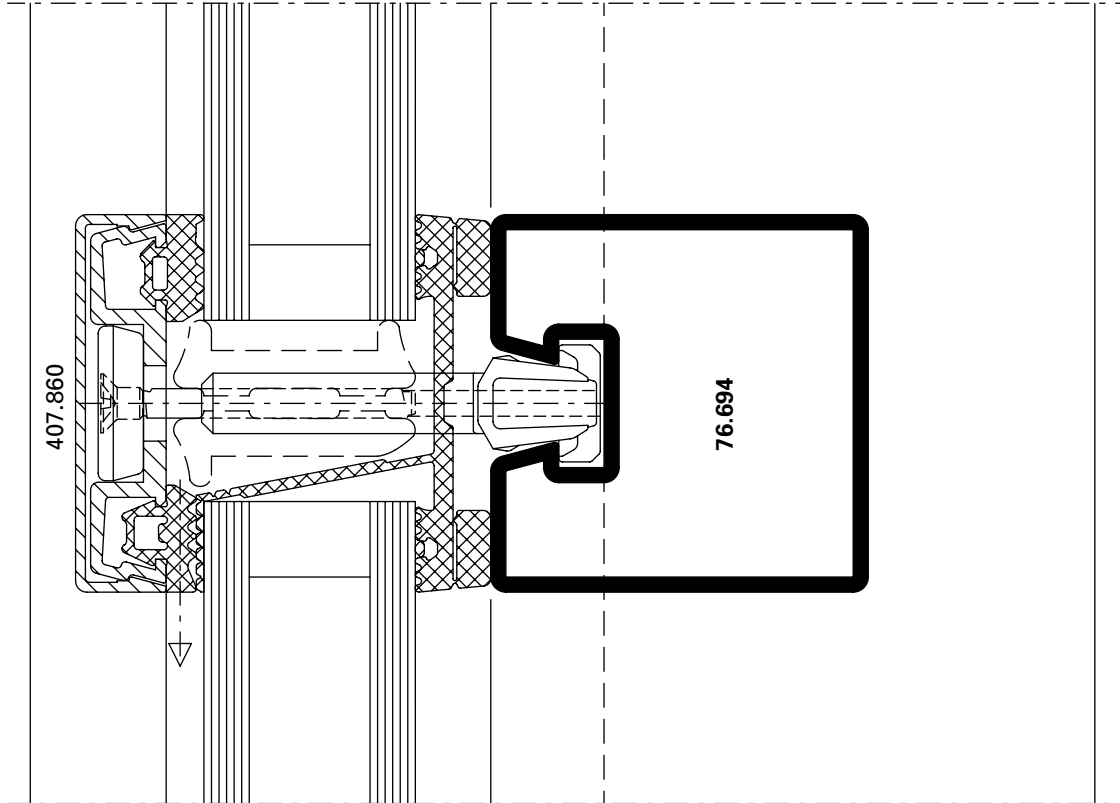

D-510-C-002

DWG

DXF

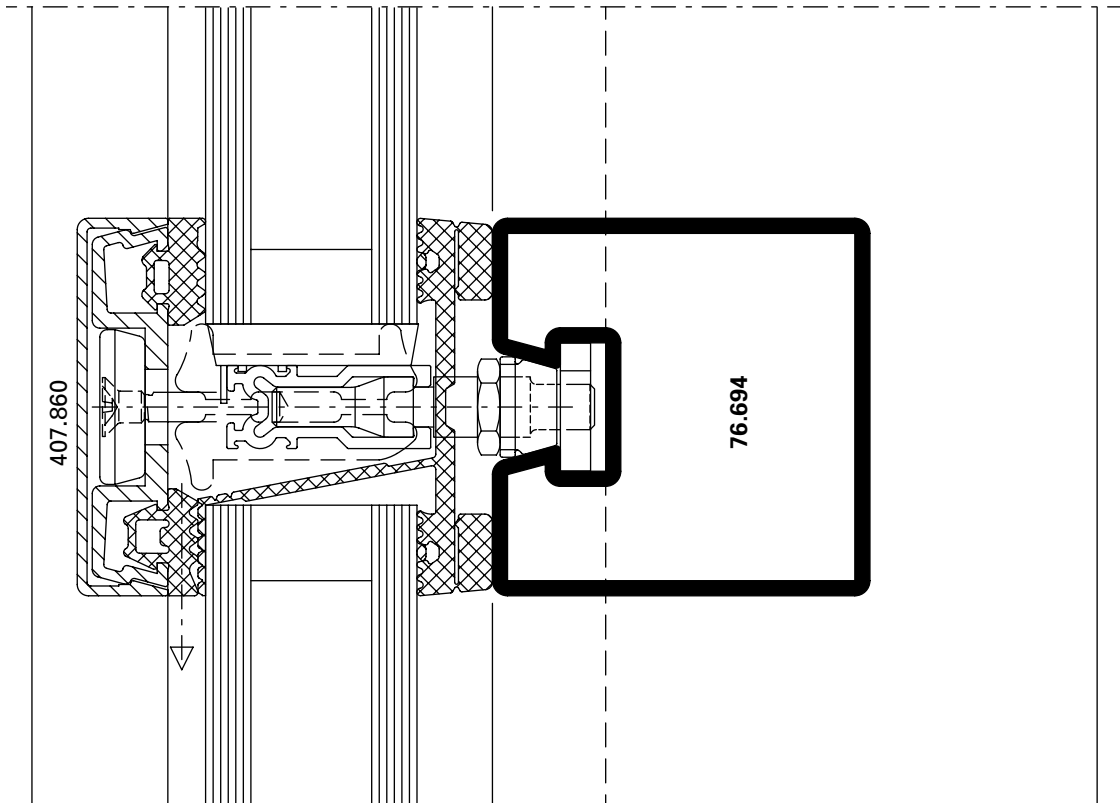

D-510-C-003

DWG

DXF

Pfosten-Detail\*  
Ansichtsbreite 50 mm

Détail du montant\*  
Largeur de face 50 mm

Detail of mullion\*  
Width 50 mm

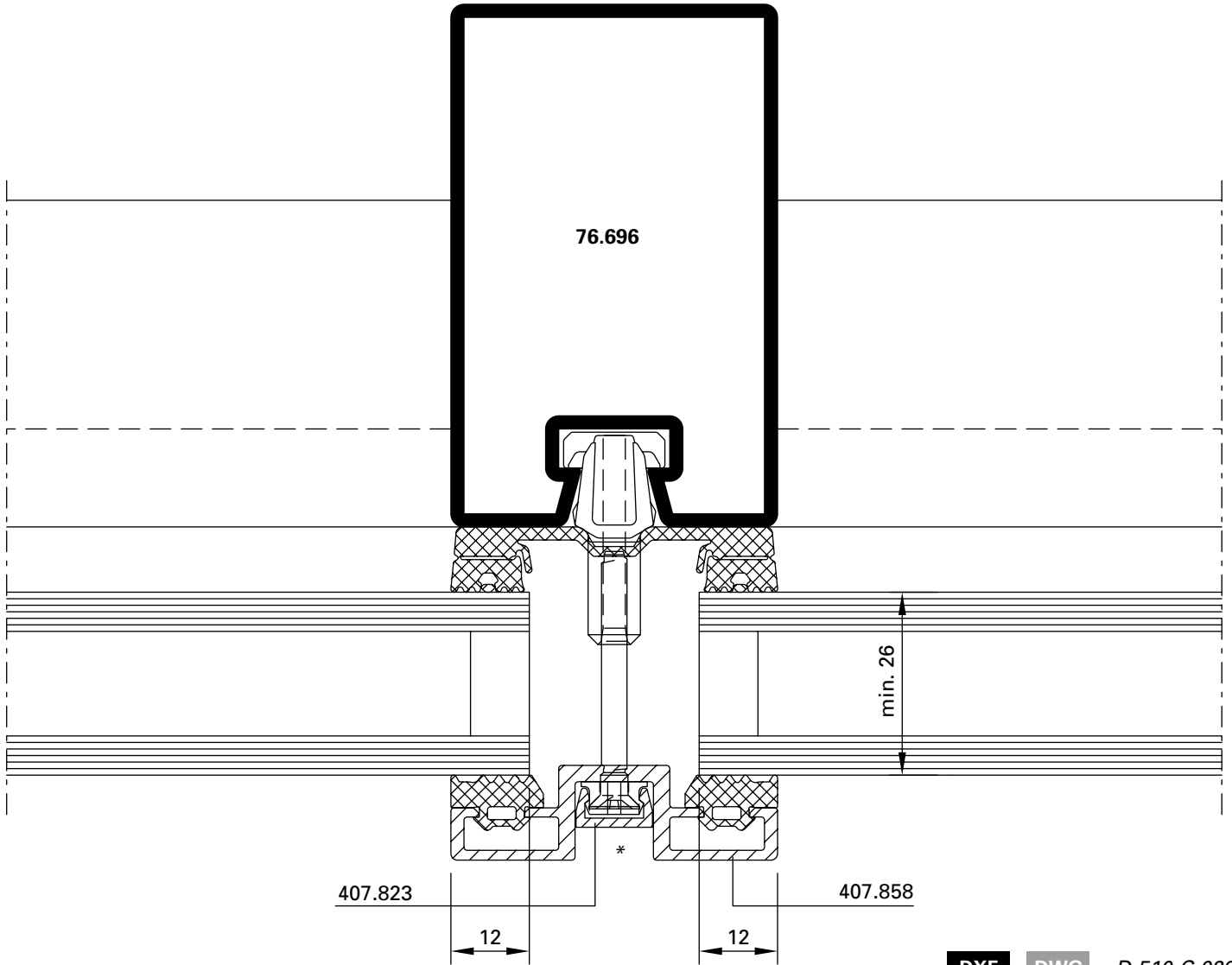

\* Sonderkonstruktion  
(nach Produktnorm EN 13830  
nicht geprüft)

\* Construction spéciale  
(non contrôlé selon la norme  
produit EN 13830)

\* Special construction  
(Not tested in accordance with the  
EN 13830 product standard)

Schnittpunkte im Massstab 1:1  
 Coupe de détails à l'échelle 1:1  
 Section details on scale 1:1

VISS Fassade  
 VISS façade  
 VISS façade

Pfosten-Detail  
 Segmentverglasung 50 mm

Détail du montant  
 Vitrage segmenté 50 mm

Detail of mullion  
 Segmental glazing, width 50 mm

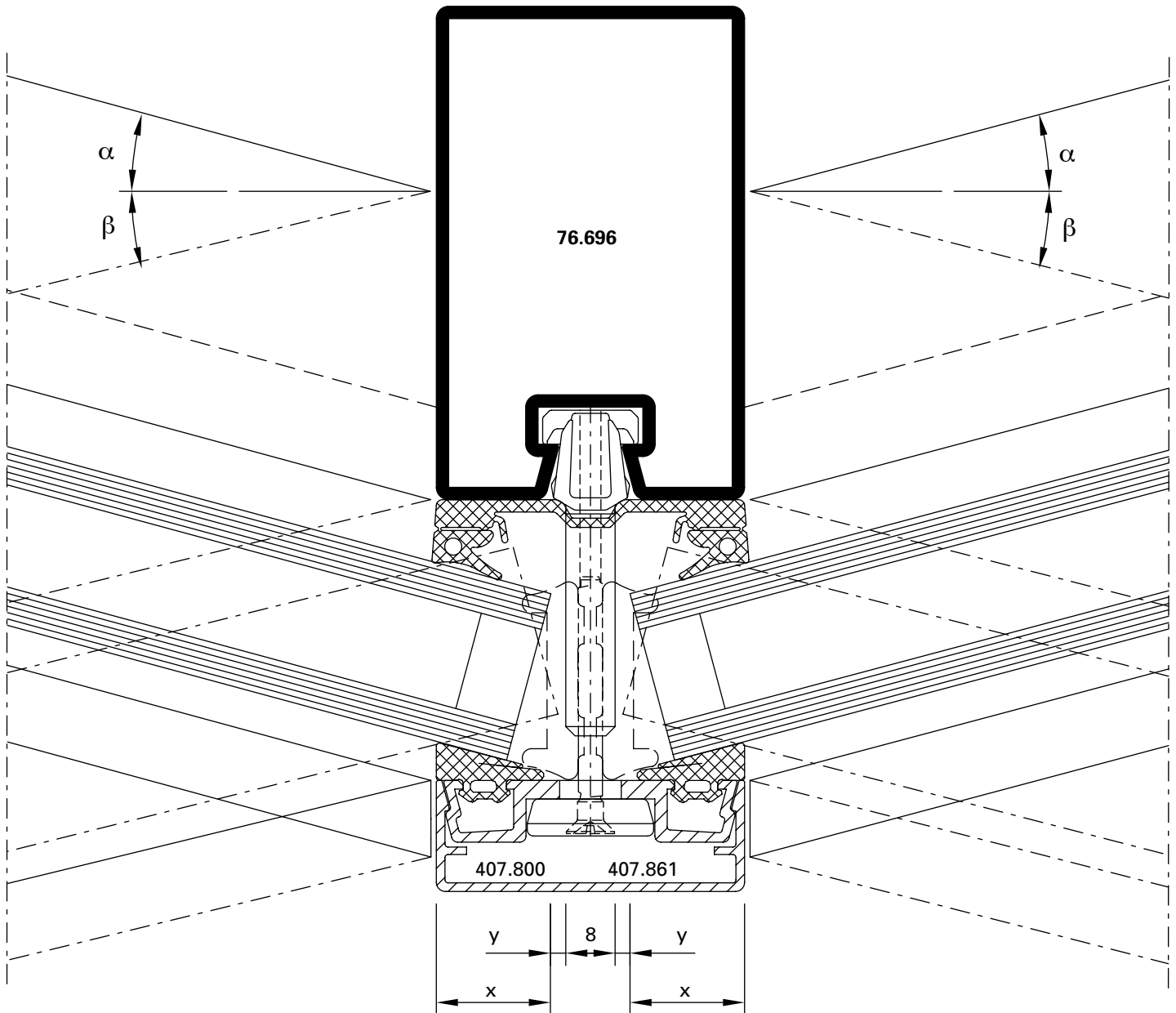

DXF DWG D-510-C-004

$\alpha$	$\beta$	Füllelement- dicke	X (max) mm	Y (min) mm
0 – 5°		20 – 45 mm	16	5
	5 – 10°	20 – 35 mm	18	3
	10 – 15°	20 – 24 mm	18	3

$\alpha$	$\beta$	Epaisseur du remplissage	X (max) mm	Y (min) mm
0 – 5°		20 – 45 mm	16	5
	5 – 10°	20 – 35 mm	18	3
	10 – 15°	20 – 24 mm	18	3

$\alpha$	$\beta$	Thickness of glass/panel	X (max) mm	Y (min) mm
0 – 5°		20 – 45 mm	16	5
	5 – 10°	20 – 35 mm	18	3
	10 – 15°	20 – 24 mm	18	3

Schnittpunkte im Massstab 1:1  
Coupe de détails à l'échelle 1:1  
Section details on scale 1:1

VISS Fassade  
VISS façade  
VISS façade

Pfosten-Detail VISS Linea  
Ansichtsbreite 50 mm

Détail du montant VISS Linea  
Largeur de face 50 mm

Detail of mullion VISS Linea  
Width 50 mm

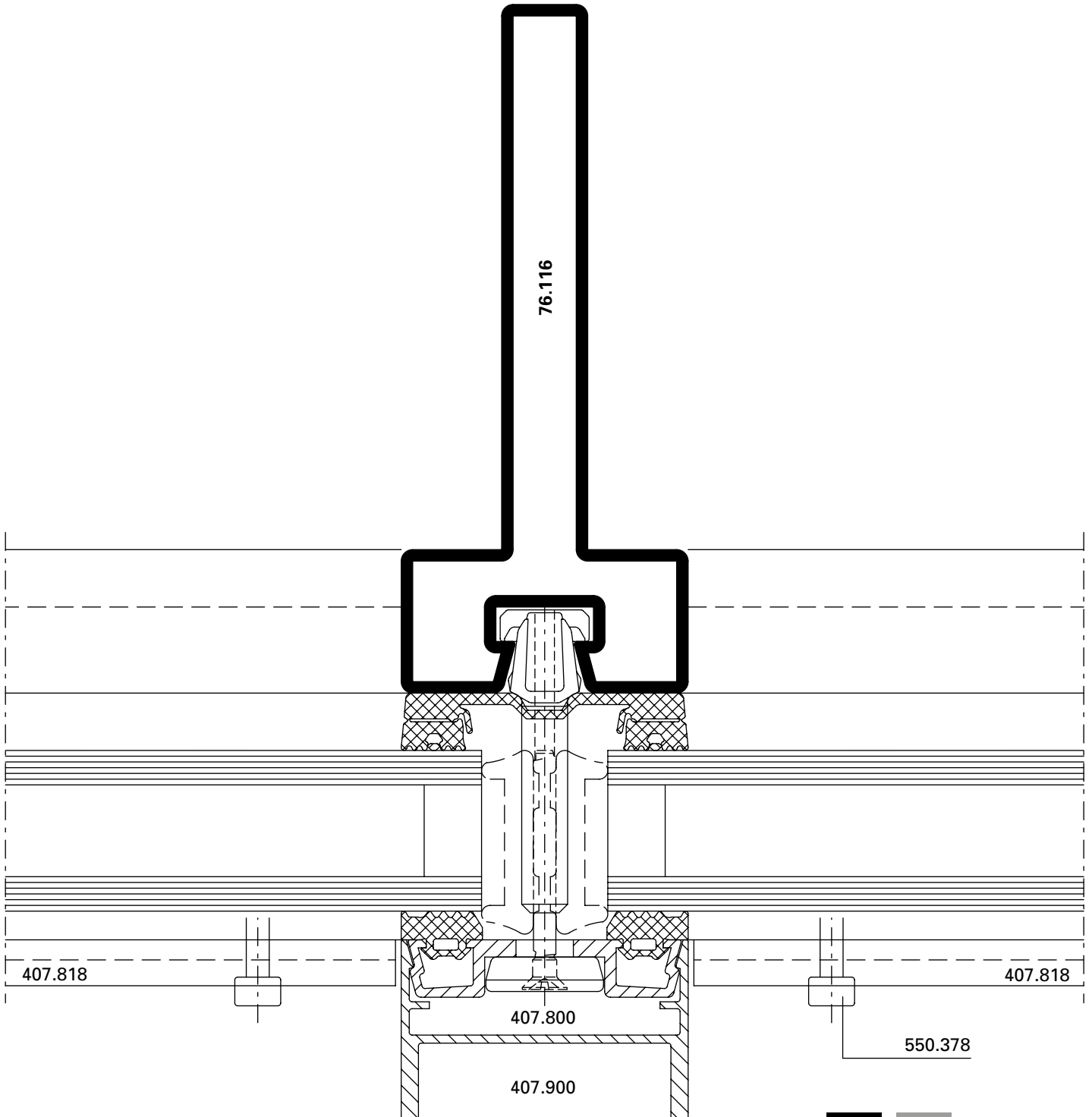

DXF

DWG

D-510-C-016

U<sub>f</sub>-Werte siehe ab Seite 22-78

Valeurs U<sub>f</sub> voir à partir de page 22-78

U<sub>f</sub> values see from page 22-78

Schnittpunkte im Massstab 1:1  
Coupe de détails à l'échelle 1:1  
Section details on scale 1:1

VISS Fassade  
VISS façade  
VISS façade

Pfosten-Detail VISS Linea  
Lasergeschweisst  
Ansichtsbreite 50 mm

Détail du montant VISS Linea  
Soudage au laser  
Largeur de face 50 mm

Detail of mullion VISS Linea  
Laser welding  
Width 50 mm

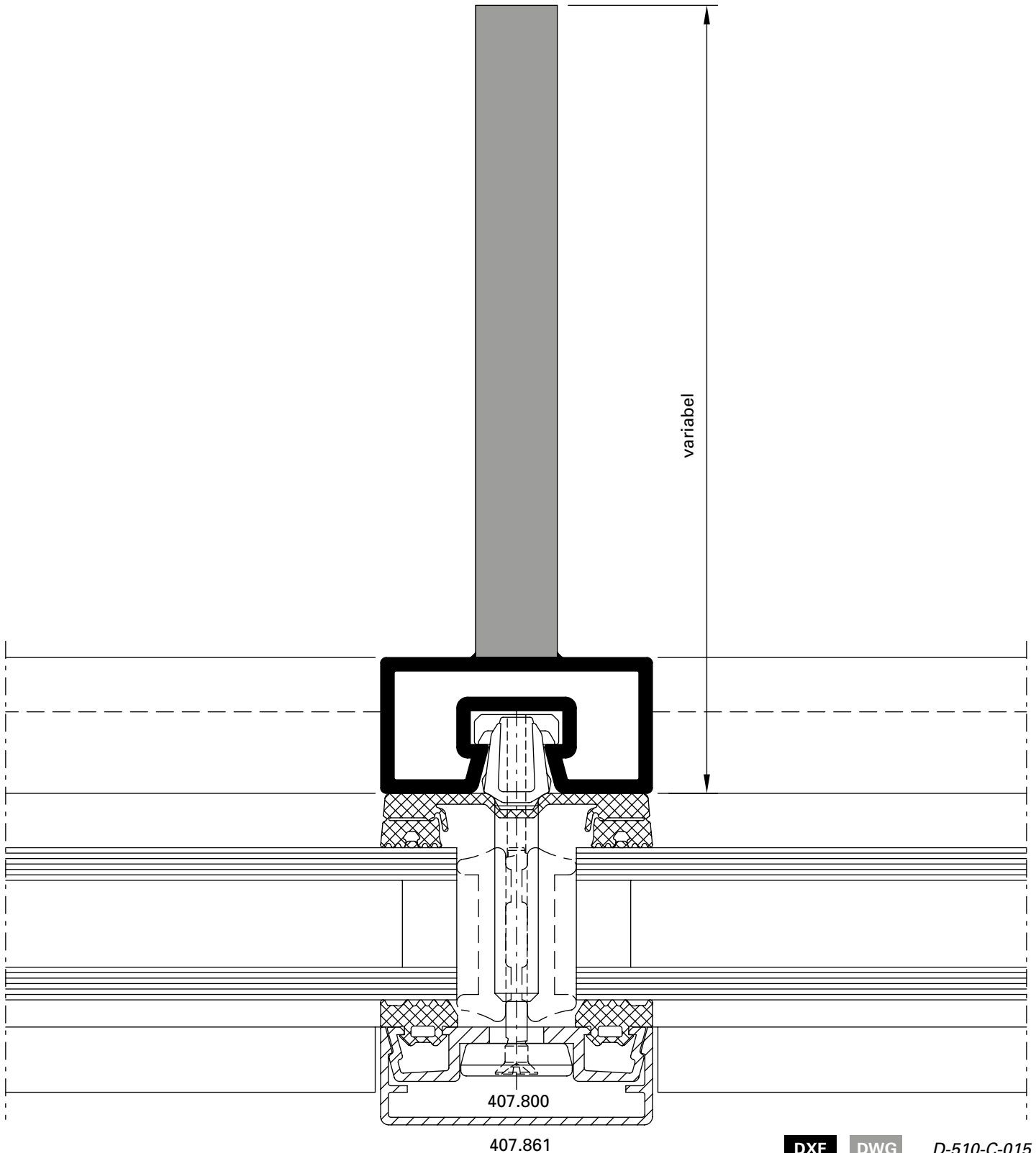

DXF

DWG

D-510-C-015

Schnittpunkte im Massstab 1:2  
Coupe de détails à l'échelle 1:2  
Section details on scale 1:2

VISS Fassade  
VISS façade  
VISS façade

Pfosten-Detail  
Flaches Deckprofil  
Ansichtsbreite 50 mm

Détail du montant  
Profilé de recouvrement plat  
Largeur de face 50 mm

Detail of mullion  
Flat cover cap  
Width 50 mm

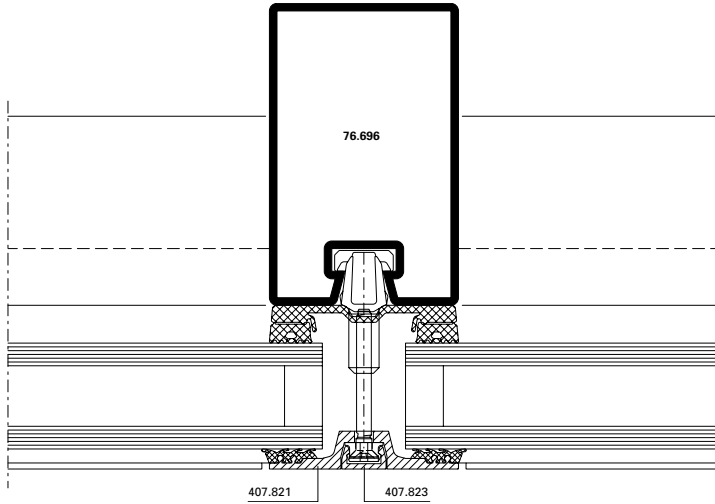

DXF

DWG

D-510-C-017

Riegel-Detail  
Flaches Deckprofil  
Ansichtsbreite 50 mm

Détail de la traverse  
Profilé de recouvrement plat  
Largeur de face 50 mm

Detail of transom  
Flat cover cap  
Width 50 mm

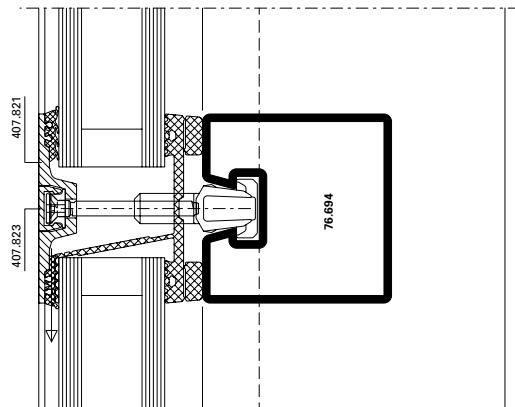

D-510-C-018

DWG

DXF

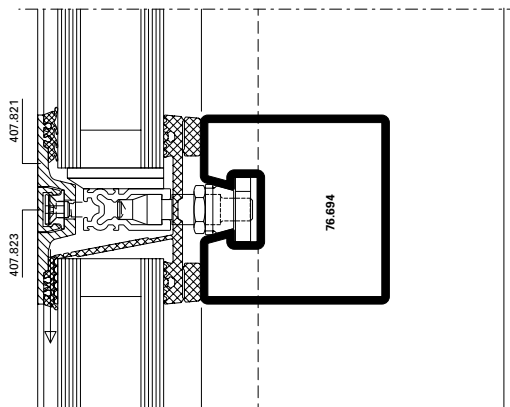

D-510-C-019

DWG

DXF



Schnittpunkte im Massstab 1:2  
 Coupe de détails à l'échelle 1:2  
 Section details on scale 1:2

VISS Fassade  
 VISS façade  
 VISS façade

Pfosten-Detail VISS Linea  
 Ansichtsbreite 50 mm

Détail du montant VISS Linea  
 Largeur de face 50 mm

Detail of mullion VISS Linea  
 Width 50 mm

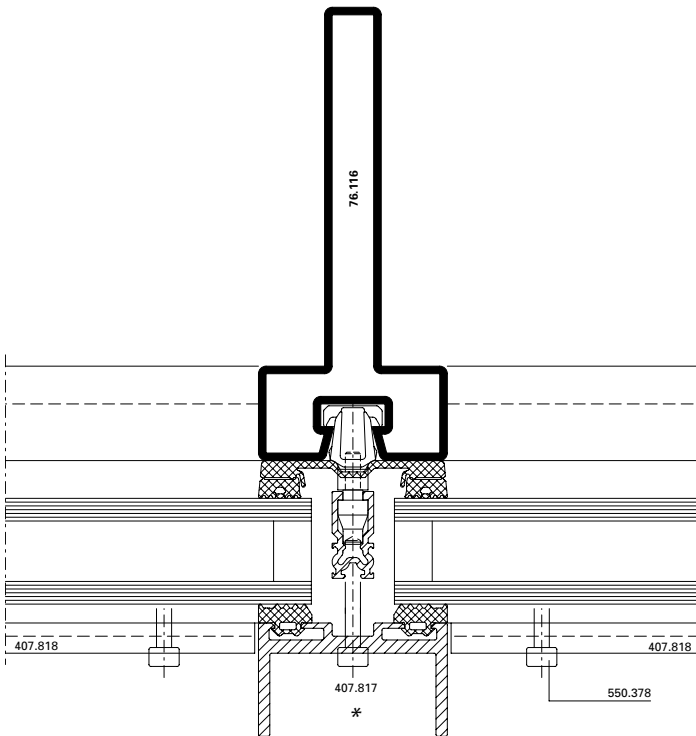

DXF

DWG

D-510-C-007

Riegel-Detail VISS Linea  
 Ansichtsbreite 50 mm

Détail de la traverse VISS Linea  
 Largeur de face 50 mm

Detail of transom VISS Linea  
 Width 50 mm

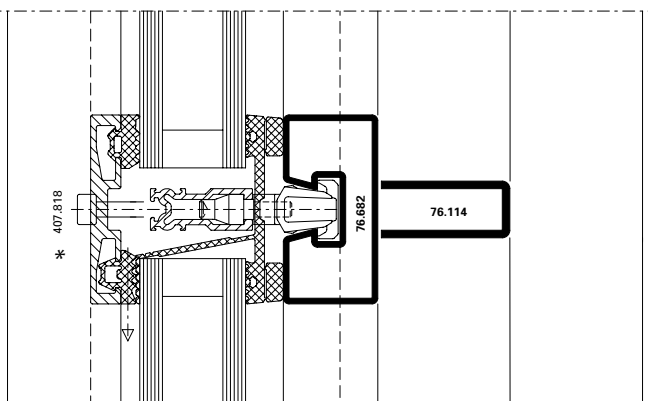

D-510-C-008

DWG

DXF

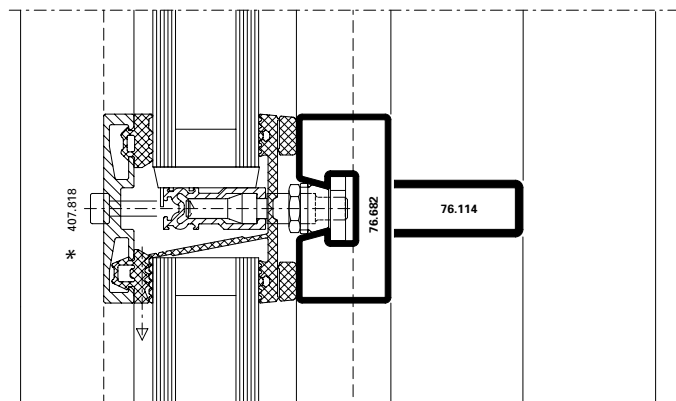

D-510-C-009

DWG

DXF

\* Sonderkonstruktion  
 (nach Produktnorm EN 13830  
 nicht geprüft)

\* Construction spéciale  
 (non contrôlé selon la norme  
 produit EN 13830)

\* Special construction  
 (Not tested in accordance with the  
 EN 13830 product standard)

Schnittpunkte im Masstab 1:2  
Coupe de détails à l'échelle 1:2  
Section details on scale 1:2

VISS Fassade  
VISS façade  
VISS façade

Pfosten-Detail  
Einfachverglasung  
Ansichtsbreite 50 mm

Détail du montant  
Vitrage simple  
Largeur de face 50 mm

Detail of mullion  
Single glazing  
Width 50 mm

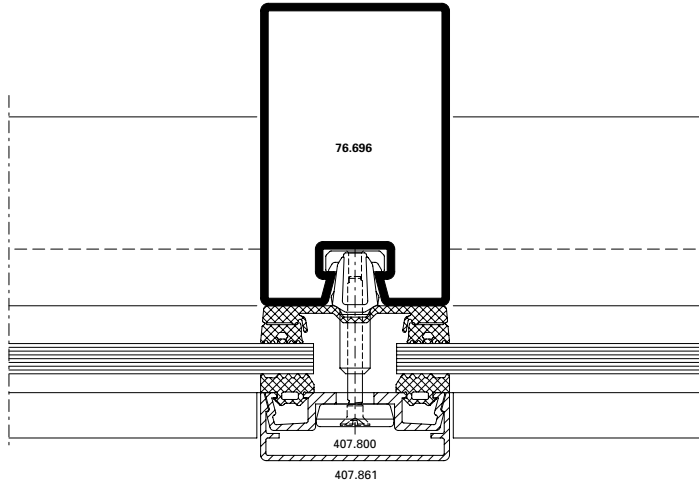

**DXF** **DWG** *D-510-C-012*

Riegel-Detail  
Einfachverglasung  
Ansichtsbreite 50 mm

Détail de la traverse  
Vitrage simple  
Largeur de face 50 mm

Detail of transom  
Single glazing  
Width 50 mm

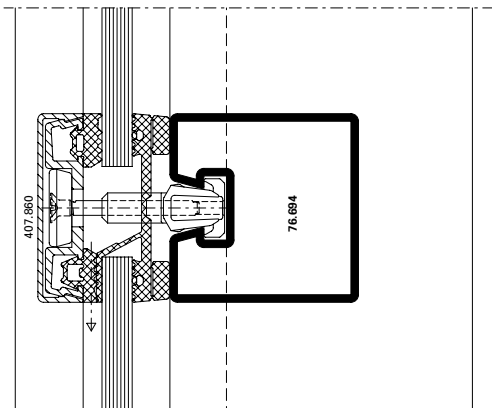

*D-510-C-013*

**DXF** **DWG**

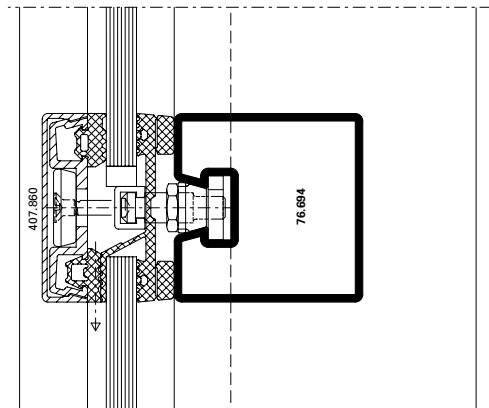

*D-510-C-014*

**DXF** **DWG**

Schnittpunkte im Massstab 1:1  
Coupe de détails à l'échelle 1:1  
Section details on scale 1:1

VISS Fassade  
VISS façade  
VISS façade

VISS HI  
Pfosten-Detail  
Ansichtsbreite 60 mm

VISS HI  
Détail du montant  
Largeur de face 60 mm

VISS HI  
Detail of mullion  
Width 60 mm

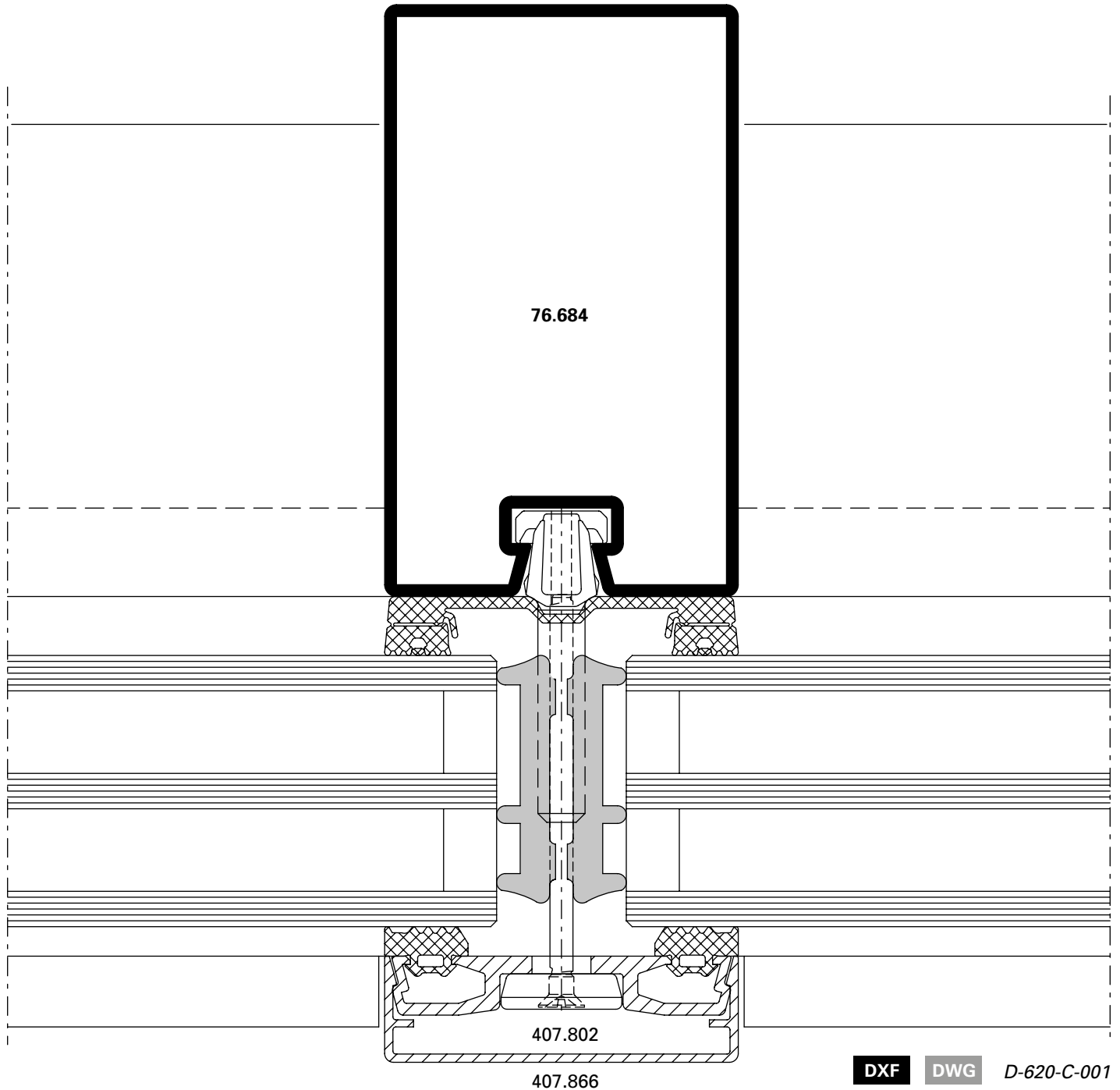

U<sub>f</sub>-Werte siehe ab Seite 22-78

Valeurs U<sub>f</sub> voir à partir de page 22-78

U<sub>f</sub> values see from page 22-78

Schnittpunkte im Massstab 1:1  
Coupe de détails à l'échelle 1:1  
Section details on scale 1:1

VISS Fassade  
VISS façade  
VISS façade

VISS HI  
Riegel-Detail  
Ansichtsbreite 60 mm

VISS HI  
Détail de la traverse  
Largeur de face 60 mm

VISS HI  
Detail of transom  
Width 60 mm

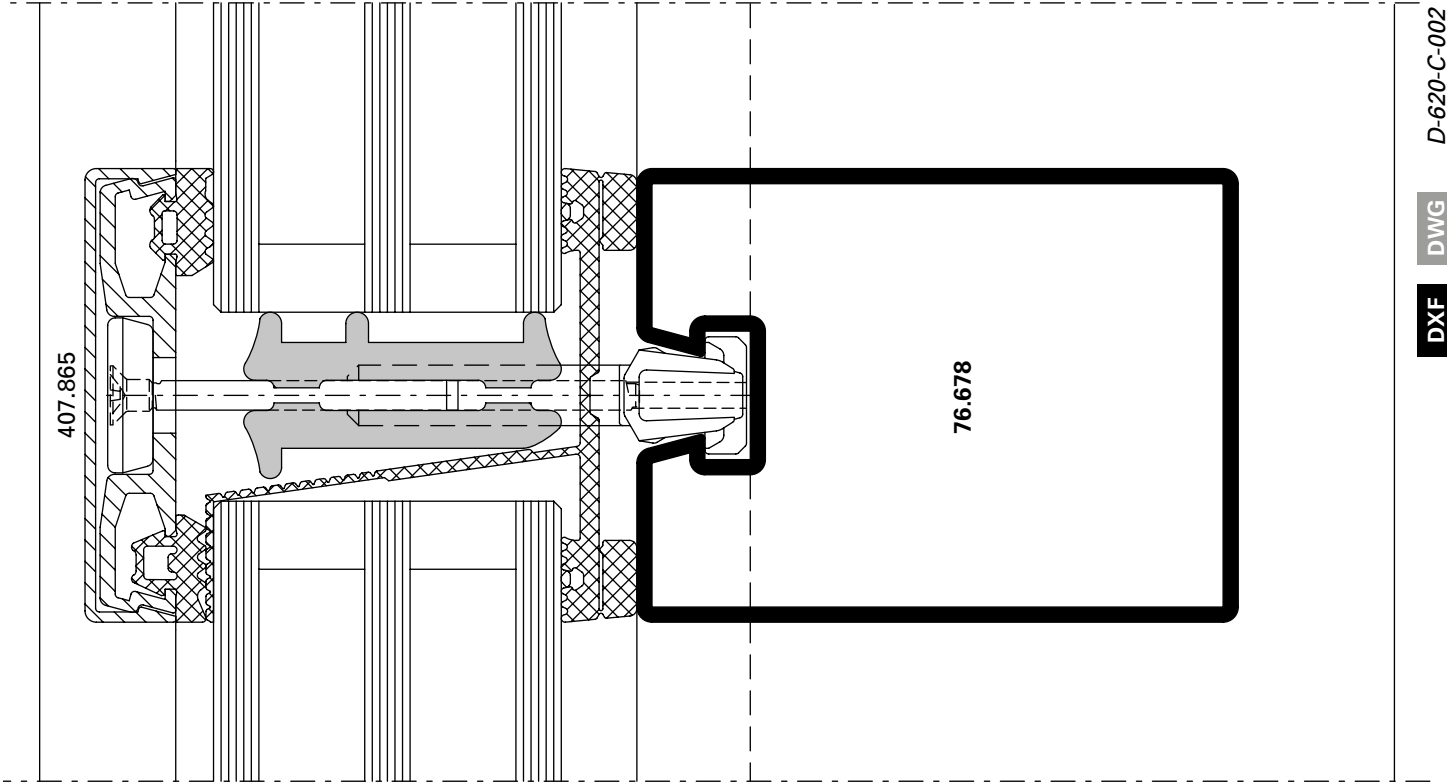

DWG D-620-C-002

DWG

DXF

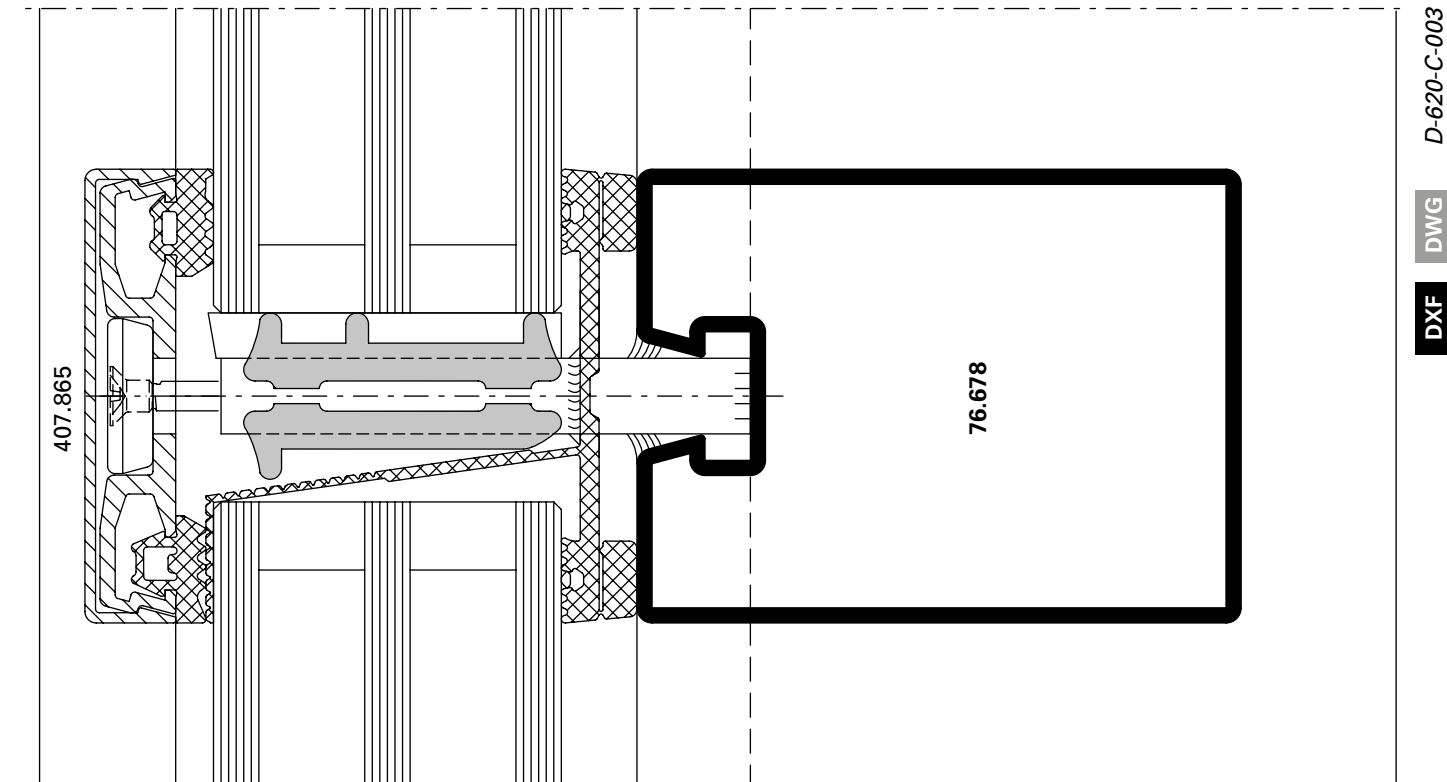

DWG D-620-C-003

DWG

DXF

Schnittpunkte im Massstab 1:1  
Coupe de détails à l'échelle 1:1  
Section details on scale 1:1

VISS Fassade  
VISS façade  
VISS façade

Pfosten-Detail  
Ansichtsbreite 60 mm

Détail du montant  
Largeur de face 60 mm

Detail of mullion  
Width 60 mm

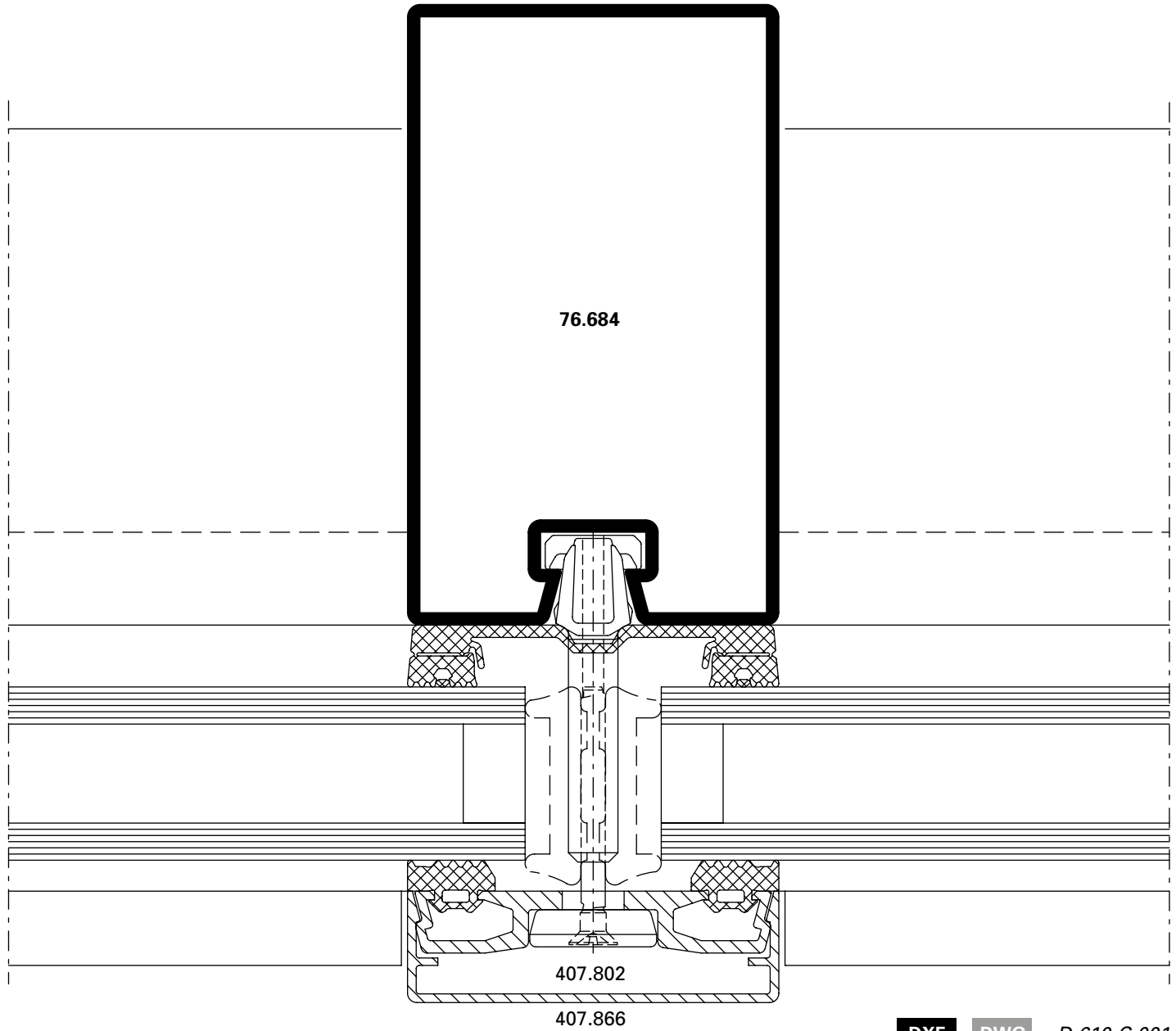

**DXF** **DWG** D-610-C-001

U<sub>f</sub>-Werte siehe ab Seite 22-78

Valeurs U<sub>f</sub> voir à partir de page 22-78

U<sub>f</sub> values see from page 22-78

Riegel-Detail  
Ansichtsbreite 60 mm

Détail de la traverse  
Largeur de face 60 mm

Detail of transom  
Width 60 mm

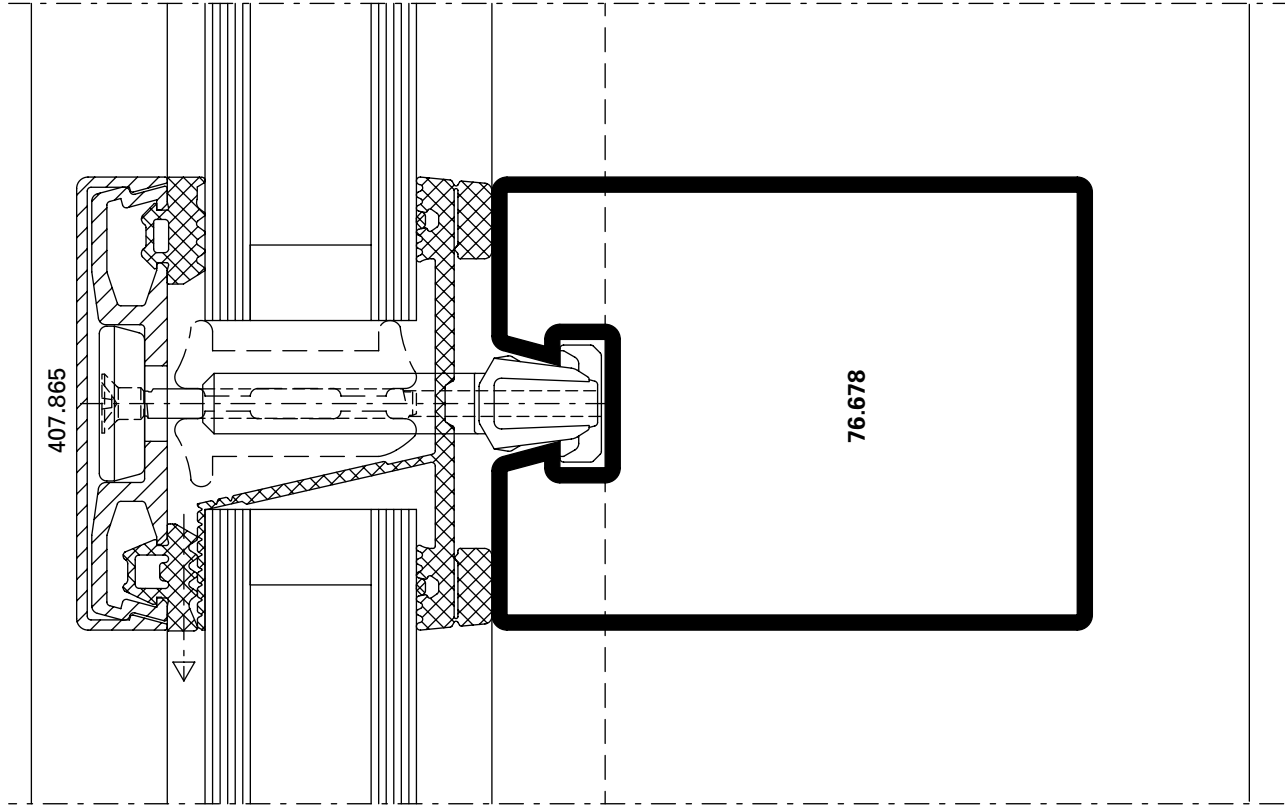

D-610-C-002

DWG

DXF

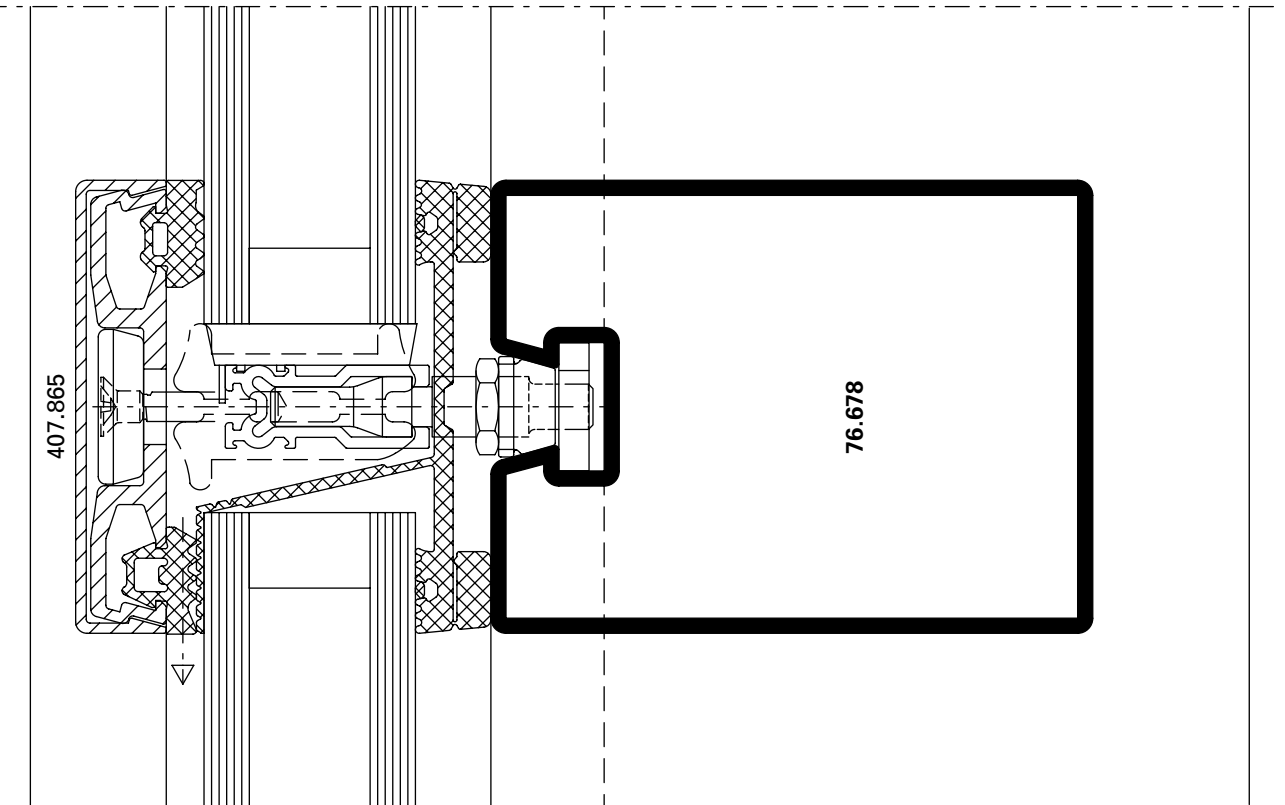

D-610-C-003

DWG

DXF

Schnittpunkte im Massstab 1:1  
Coupe de détails à l'échelle 1:1  
Section details on scale 1:1

VISS Fassade  
VISS façade  
VISS façade

Pfosten-Detail VISS Delta  
Ansichtsbreite 60 mm

Détail du montant VISS Delta  
Largeur de face 60 mm

Detail of mullion VISS Delta  
Width 60 mm

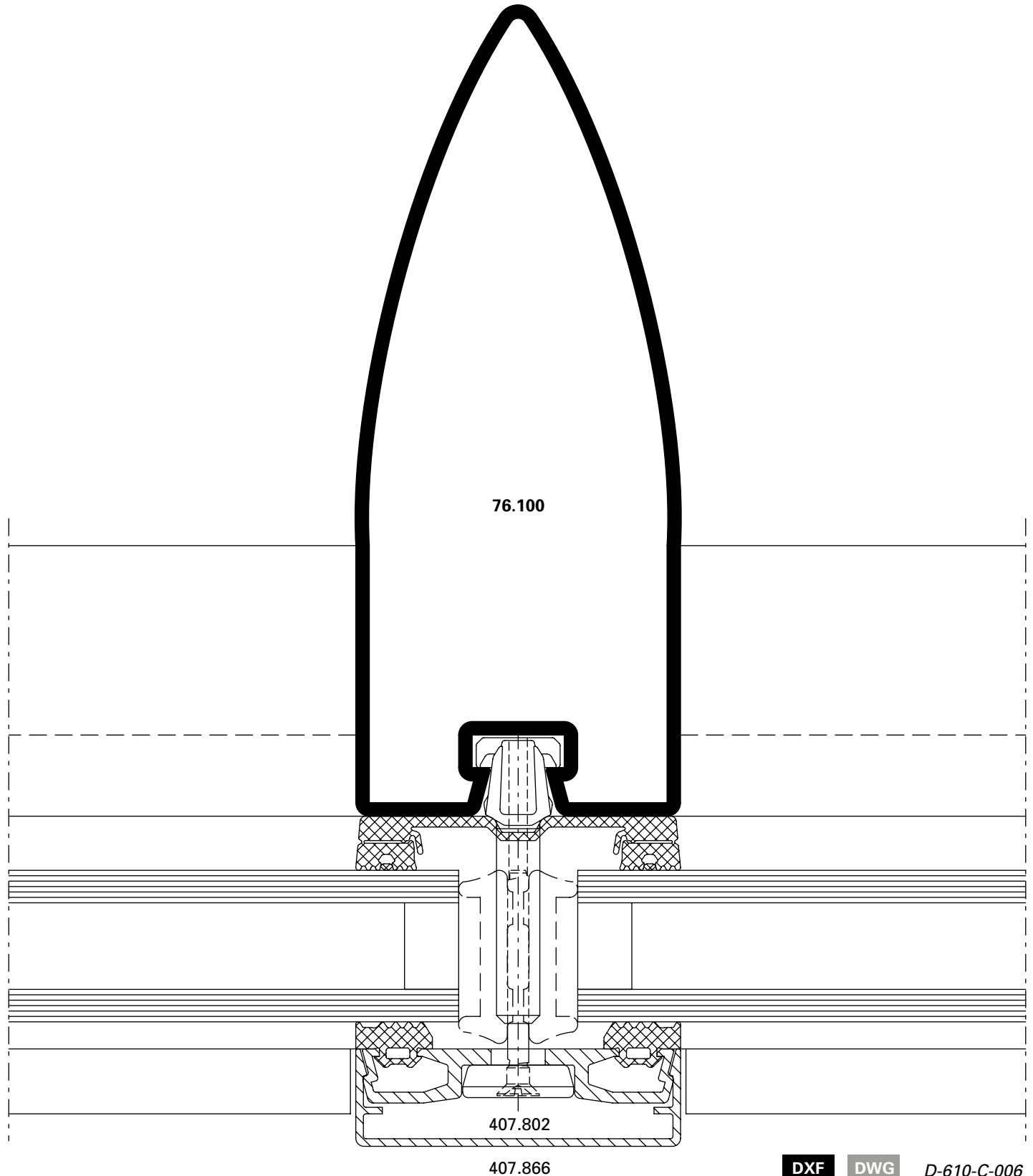

Pfosten-Detail VISS Delta\*  
Ansichtsbreite 60 mm

Détail du montant VISS Delta\*  
Largeur de face 60 mm

Detail of mullion VISS Delta\*  
Width 60 mm

\* Sonderkonstruktion  
(nach Produktnorm EN 13830  
nicht geprüft)

\* Construction spéciale  
(non contrôlé selon la norme  
produit EN 13830)

\* Special construction  
(Not tested in accordance with the  
EN 13830 product standard)

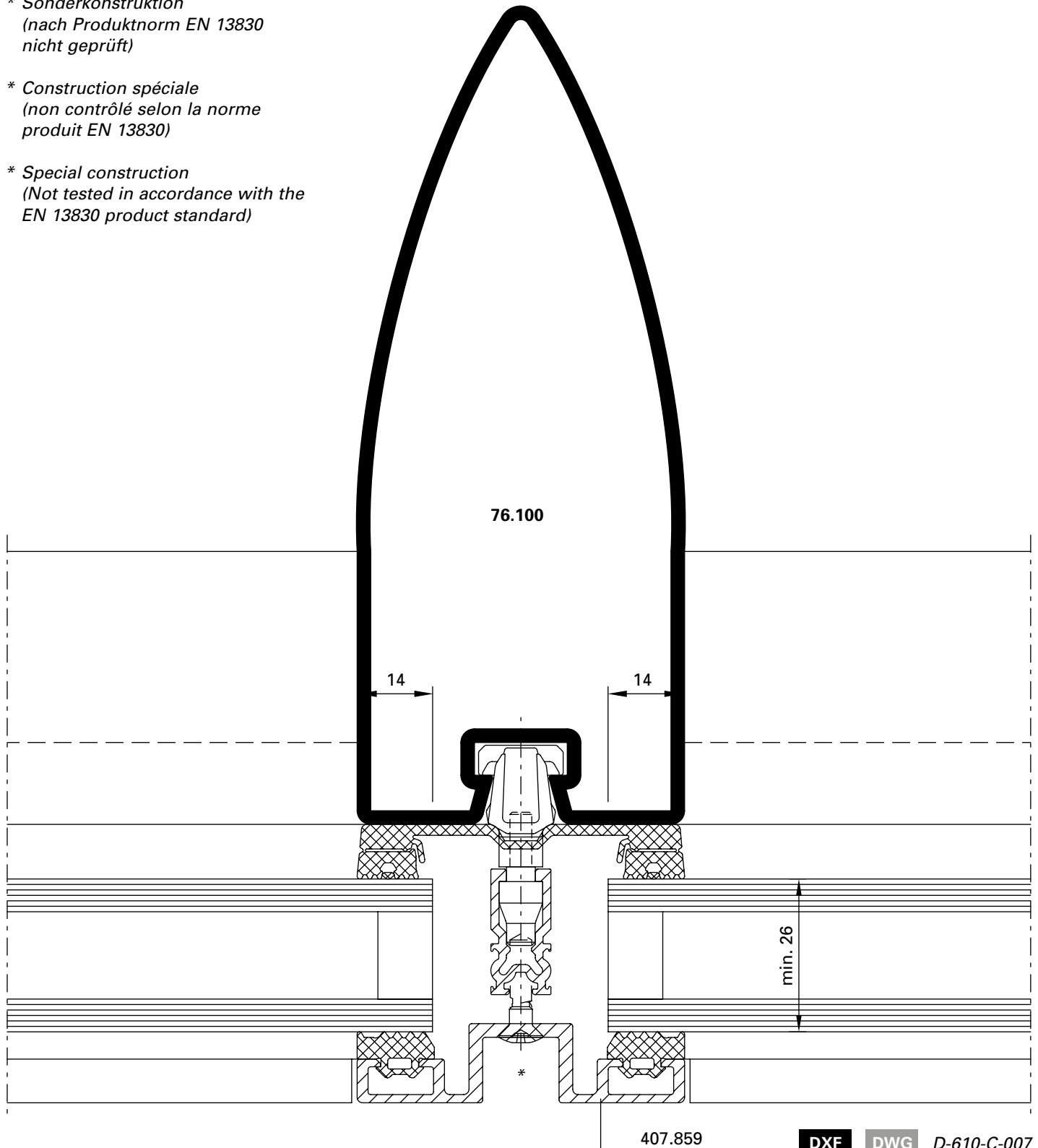



Schnittpunkte im Massstab 1:1  
 Coupe de détails à l'échelle 1:1  
 Section details on scale 1:1

VISS Fassade  
 VISS façade  
 VISS façade

Pfosten-Detail  
 Segmentverglasung 60 mm

Détail du montant  
 Vitrage segmenté 60 mm

Detail of mullion  
 Segmental glazing, width 60 mm

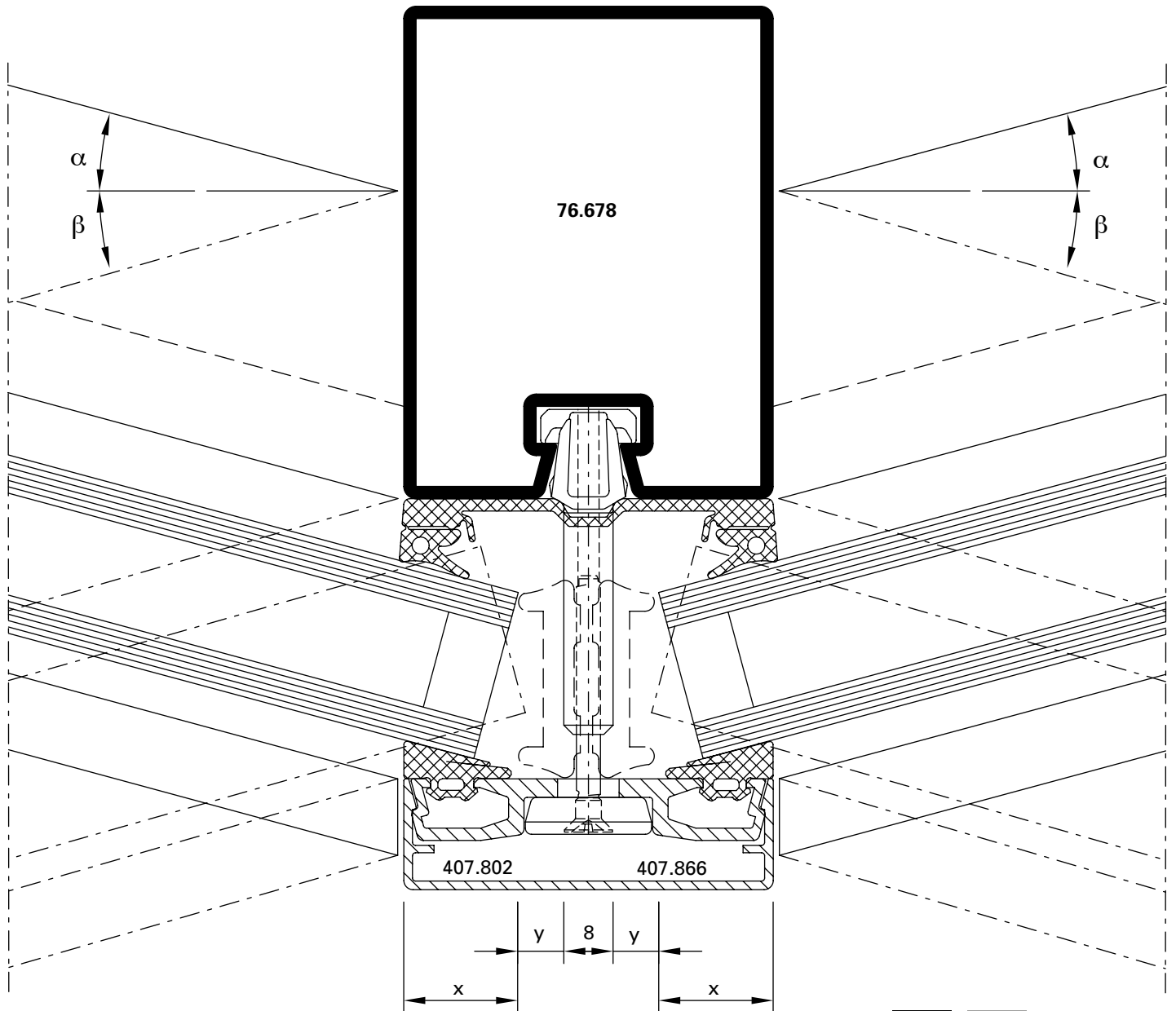

DXF DWG D-610-C-004

$\alpha$	$\beta$	Füllelement- dicke	X (max) mm	Y (min) mm
0 – 5°		20 – 70 mm	21	5
5 – 10°		20 – 50 mm	21	5
10 – 15°		20 – 35 mm	21	5

$\alpha$	$\beta$	Epaisseur du remplissage	X (max) mm	Y (min) mm
0 – 5°		20 – 70 mm	21	5
5 – 10°		20 – 50 mm	21	5
10 – 15°		20 – 35 mm	21	5

$\alpha$	$\beta$	Thickness of glass/panel	X (max) mm	Y (min) mm
0 – 5°		20 – 70 mm	21	5
5 – 10°		20 – 50 mm	21	5
10 – 15°		20 – 35 mm	21	5

**Schnittpunkte im Massstab 1:2**  
**Coupe de détails à l'échelle 1:2**  
**Section details on scale 1:2**

VISS Fassade  
 VISS façade  
 VISS façade

**Pfosten-Detail**  
**Flaches Deckprofil**  
**Ansichtsbreite 60 mm**

**Détail du montant**  
**Profilé de recouvrement plat**  
**Largeur de face 60 mm**

**Detail of mullion**  
**Flat cover cap**  
**Width 60 mm**

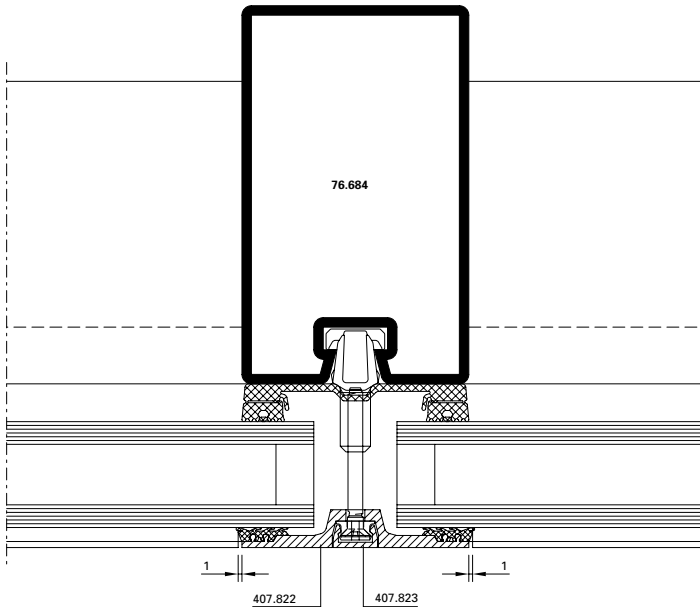

**DXF** **DWG** *D-610-C-011*

**Riegel-Detail**  
**Flaches Deckprofil**  
**Ansichtsbreite 60 mm**

**Détail de la traverse**  
**Profilé de recouvrement plat**  
**Largeur de face 60 mm**

**Detail of transom**  
**Flat cover cap**  
**Width 60 mm**

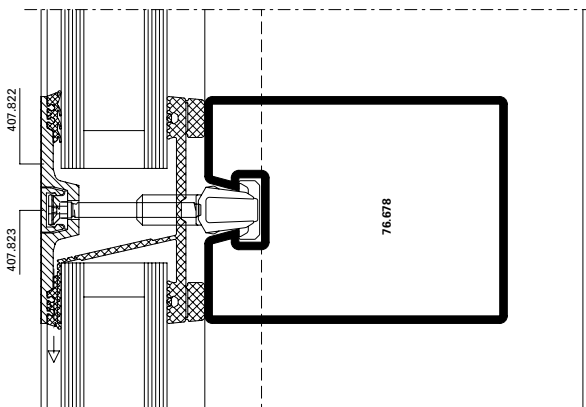

**DXF** **DWG** *D-610-C-012*

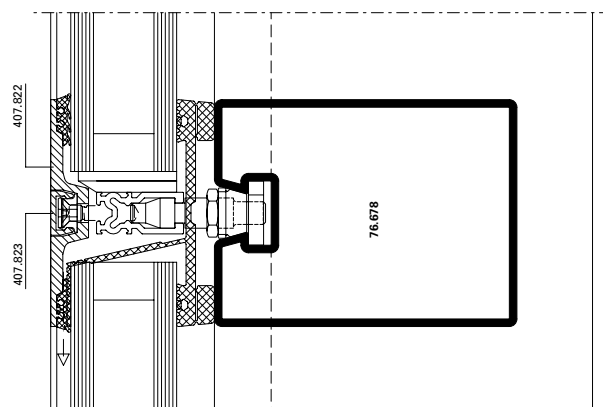

**DXF** **DWG** *D-610-C-013*

Schnittpunkte im Massstab 1:2  
Coupe de détails à l'échelle 1:2  
Section details on scale 1:2

VISS Fassade  
VISS façade  
VISS façade

Pfosten-Detail  
Einfachverglasung  
Ansichtsbreite 60 mm

Détail du montant  
Vitrage simple  
Largeur de face 60 mm

Detail of mullion  
Single glazing  
Width 60 mm

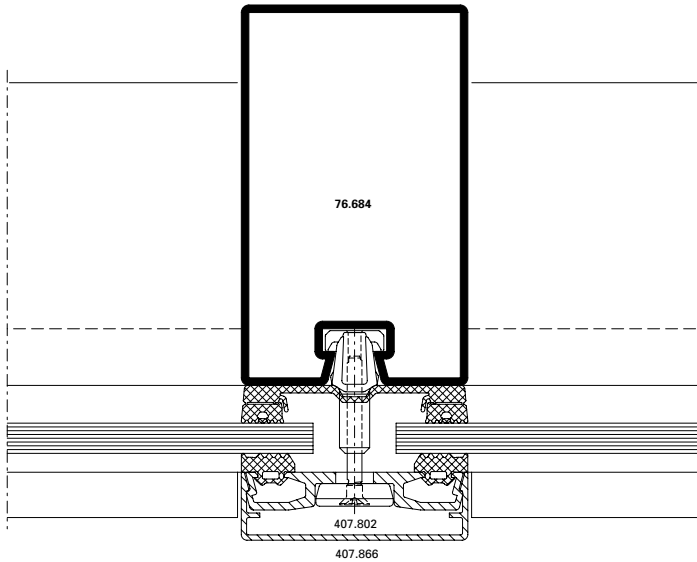

DXF DWG D-610-C-008

Riegel-Detail  
Einfachverglasung  
Ansichtsbreite 60 mm

Détail de la traverse  
Vitrage simple  
Largeur de face 60 mm

Detail of transom  
Single glazing  
Width 60 mm

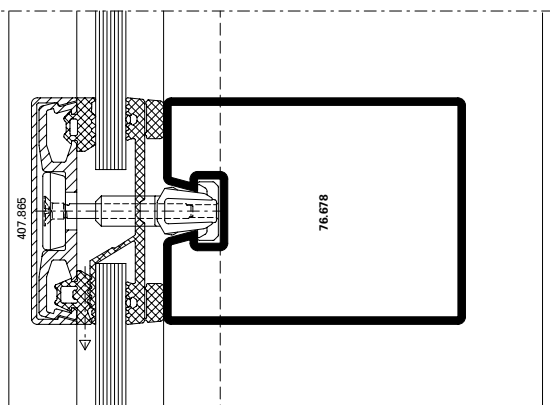

D-610-C-009

DXF DWG

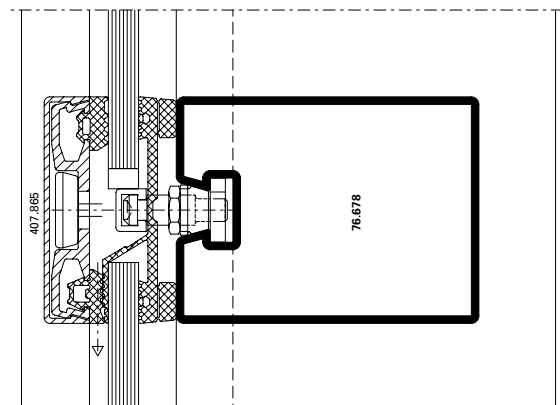

D-610-C-010

DXF DWG

Einsatzelement  
 Janisol HI Türe

Élément de remplissage  
 Porte Janisol HI

Infill element  
 Janisol HI door

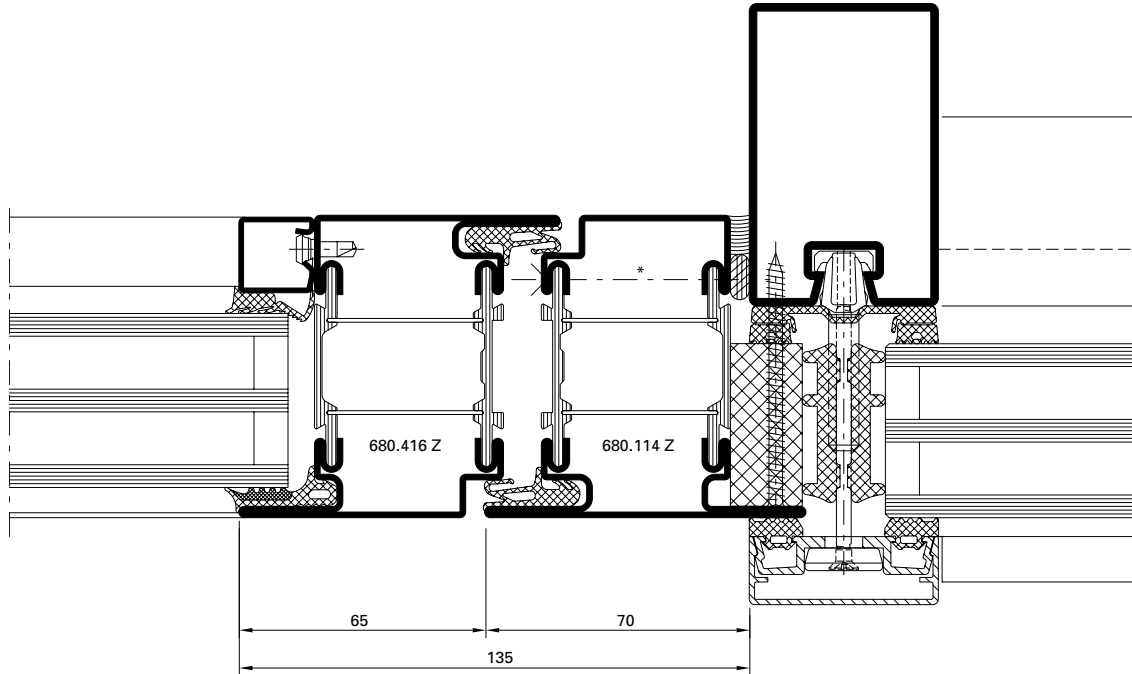

DXF DWG

D-160-A-012

Einsatzelement  
 Janisol HI Fenster

Élément de remplissage  
 Fenêtre Janisol HI

Infill element  
 Janisol HI window

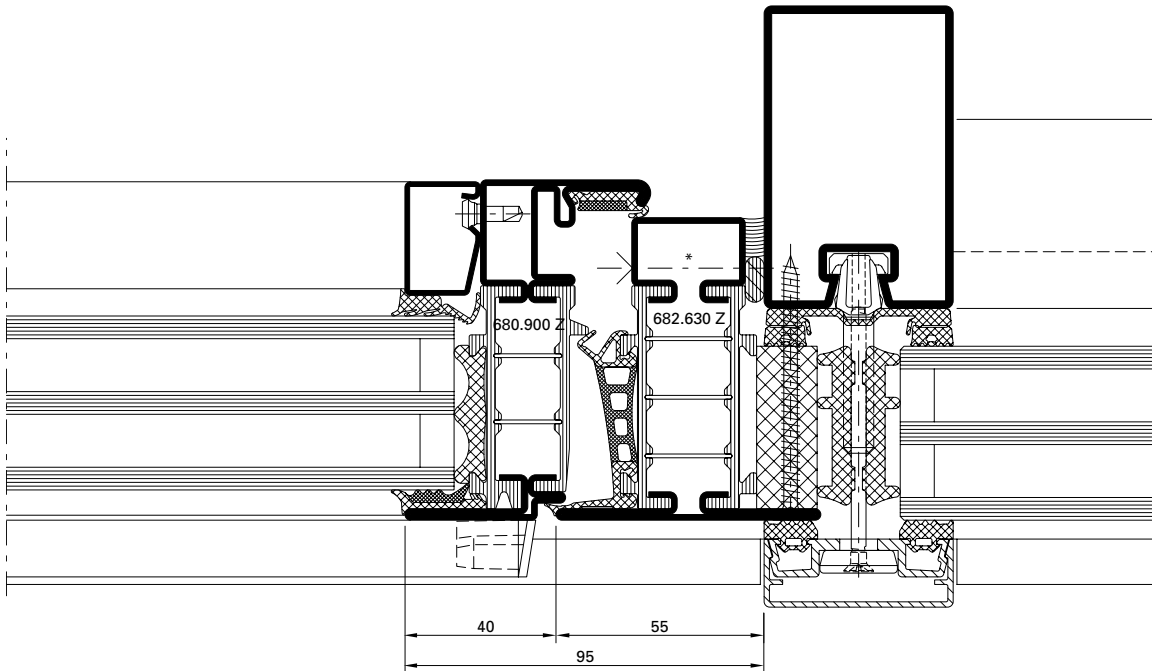

DXF DWG

D-161-A-018

\* Bei grossen, schweren und/oder stark frequentierten Türanlagen ist eine zusätzliche Verschraubung im Bandbereich erforderlich.

\* Pour les portes lourdes de grandes dimensions et/ou fortement fréquentées, un vissage supplémentaire au niveau des paumelles est nécessaire.

\* for large heavy and/or frequently used door systems, additional screw connections are required in the hinge area.

Einsatzelement  
 Janisol Türe

Élément de remplissage  
 Porte Janisol

Infill element  
 Janisol door

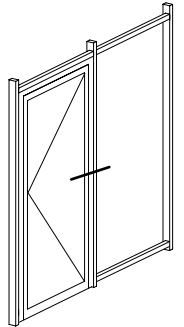
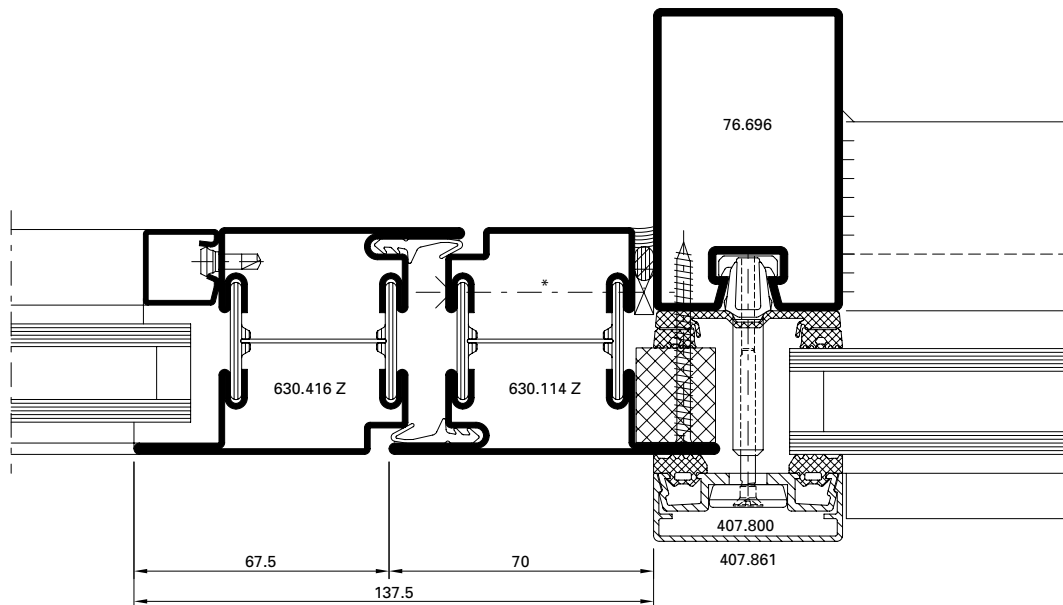

DXF DWG

D-510-K-002

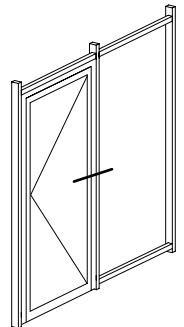
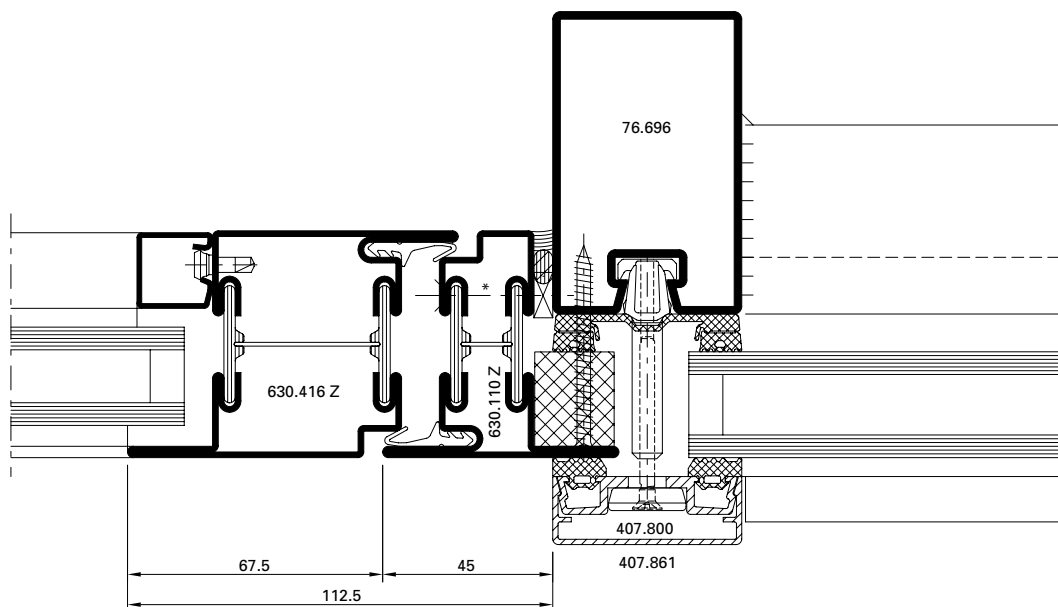

DXF DWG

D-510-K-007

\* Bei grossen, schweren und/oder stark frequentierten Türanlagen ist eine zusätzliche Verschraubung im Bandbereich erforderlich.

\* Pour les portes lourdes de grandes dimensions et/ou fortement fréquentées, un vissage supplémentaire au niveau des paumelles est nécessaire.

\* for large heavy and/or frequently used door systems, additional screw connections are required in the hinge area.

Einsatzelement  
 Fenster Janisol Primo

Élément de remplissage  
 Fenêtre Janisol Primo

Infill element  
 Janisol Primo window

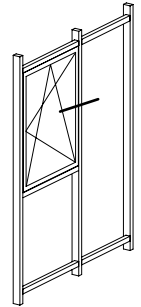
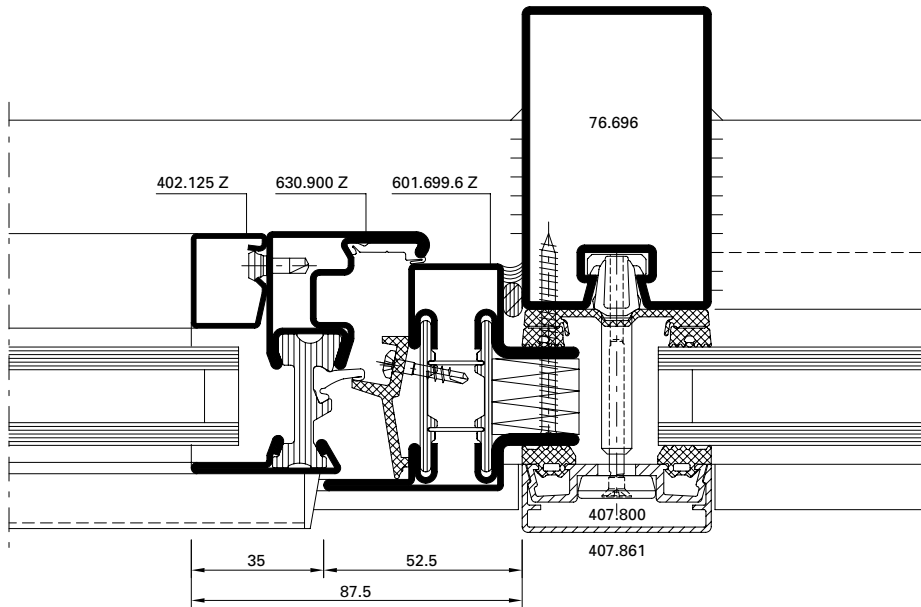

DXF DWG

D-510-K-001

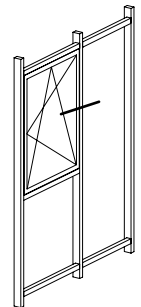
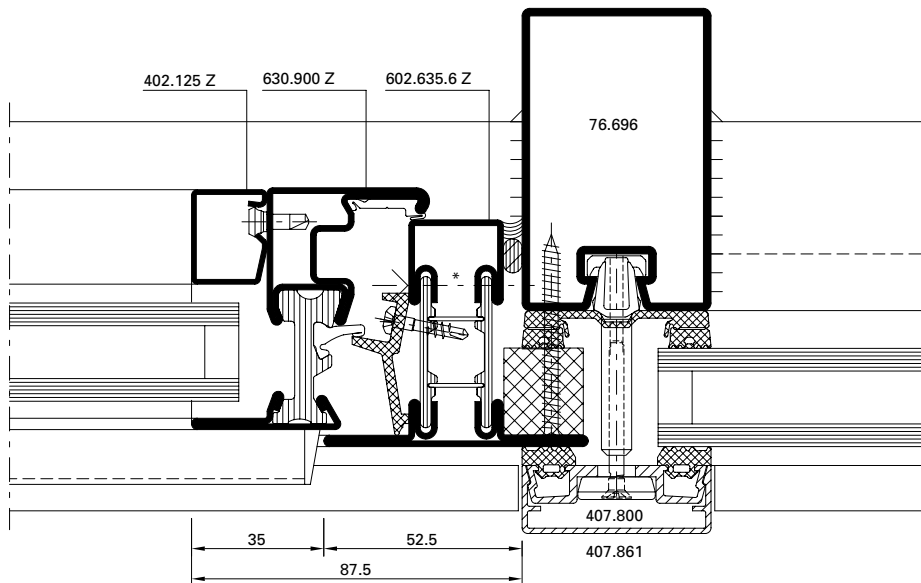

DXF DWG

D-510-K-006

\* Bei grossen, schweren und/oder stark frequentierten Türanlagen ist eine zusätzliche Verschraubung im Bandbereich erforderlich.

\* Pour les portes lourdes de grandes dimensions et/ou fortement fréquentées, un vissage supplémentaire au niveau des paumelles est nécessaire.

\* for large heavy and/or frequently used door systems, additional screw connections are required in the hinge area.

Aussenecke 90°

Angle extérieur 90°

Outer corner 90°

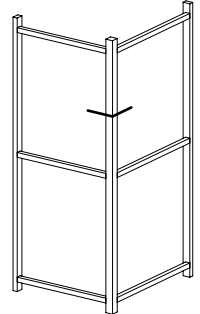
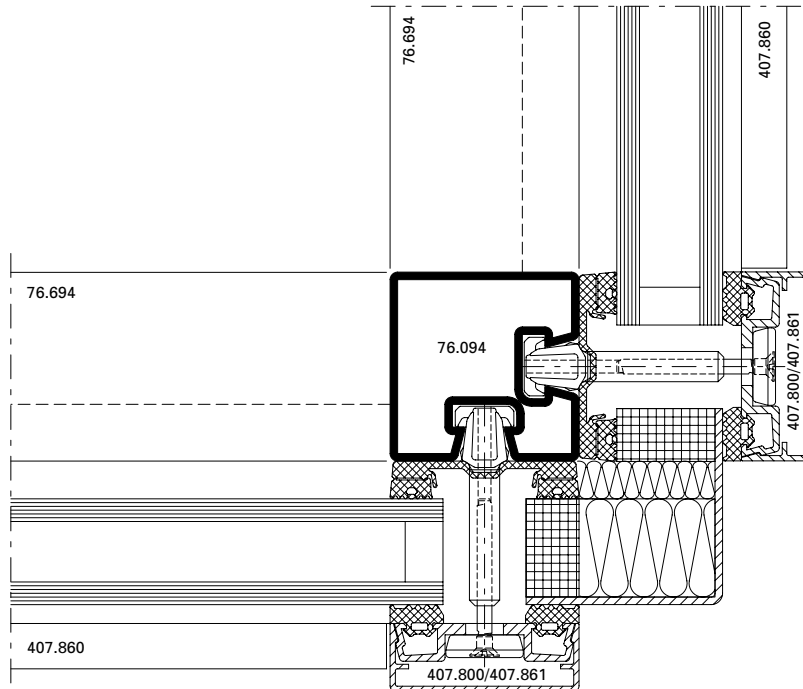

DXF DWG

D-510-K-011

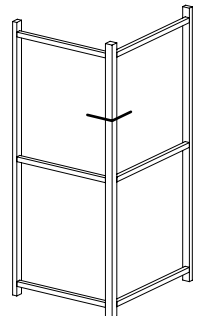
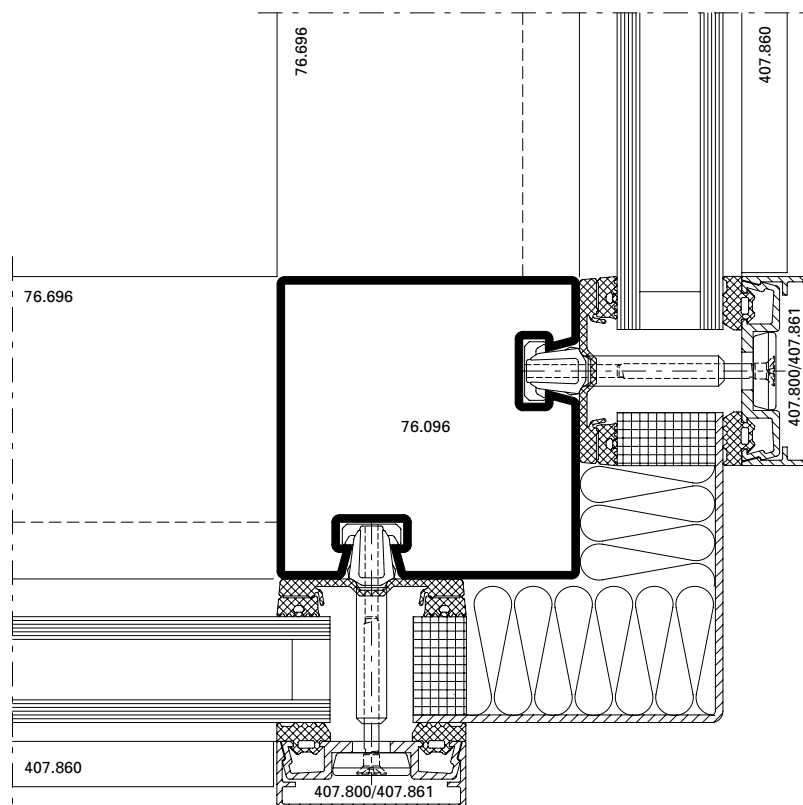

DXF DWG

D-510-K-012

Aussenecke 90°

Angle extérieur 90°

Outer corner 90°

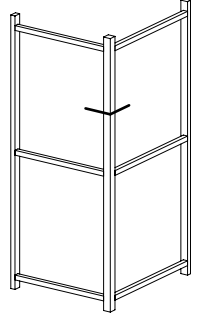
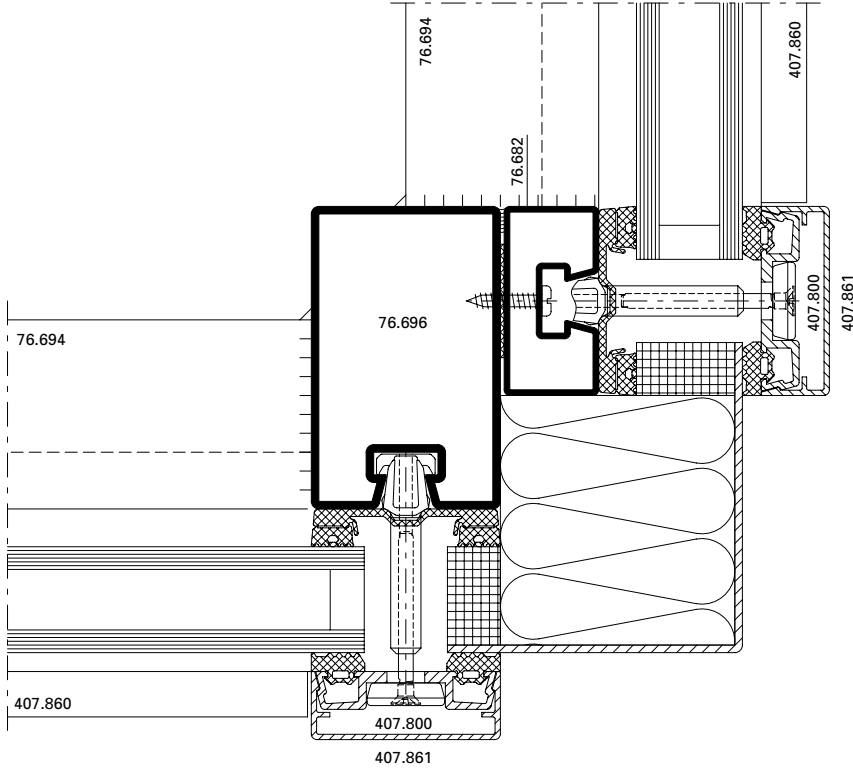

DXF DWG

D-510-K-005

Aussenecke 90°  
 (Kombination mit VISS Basic)

Angle extérieur 90°  
 (en combinaison avec VISS Basic)

Outer corner 90°  
 (in combination with VISS Basic)

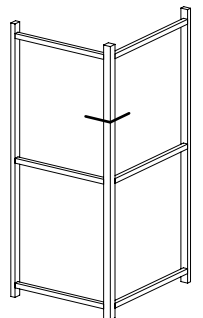
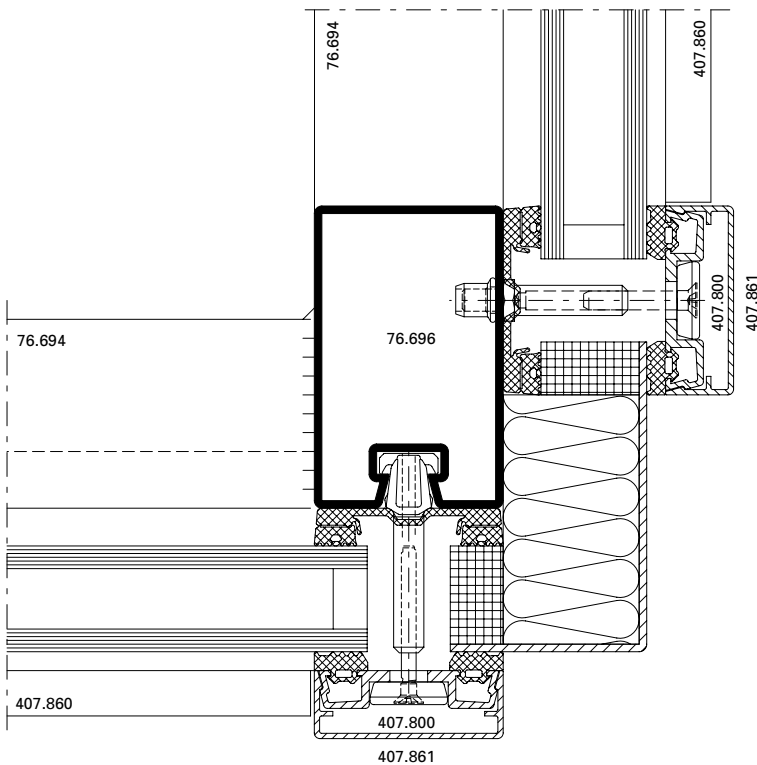

DXF DWG

D-510-K-010



Aussenecke 135°

Angle extérieur 135°

Outer corner 135°

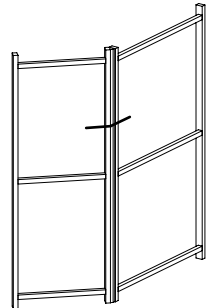
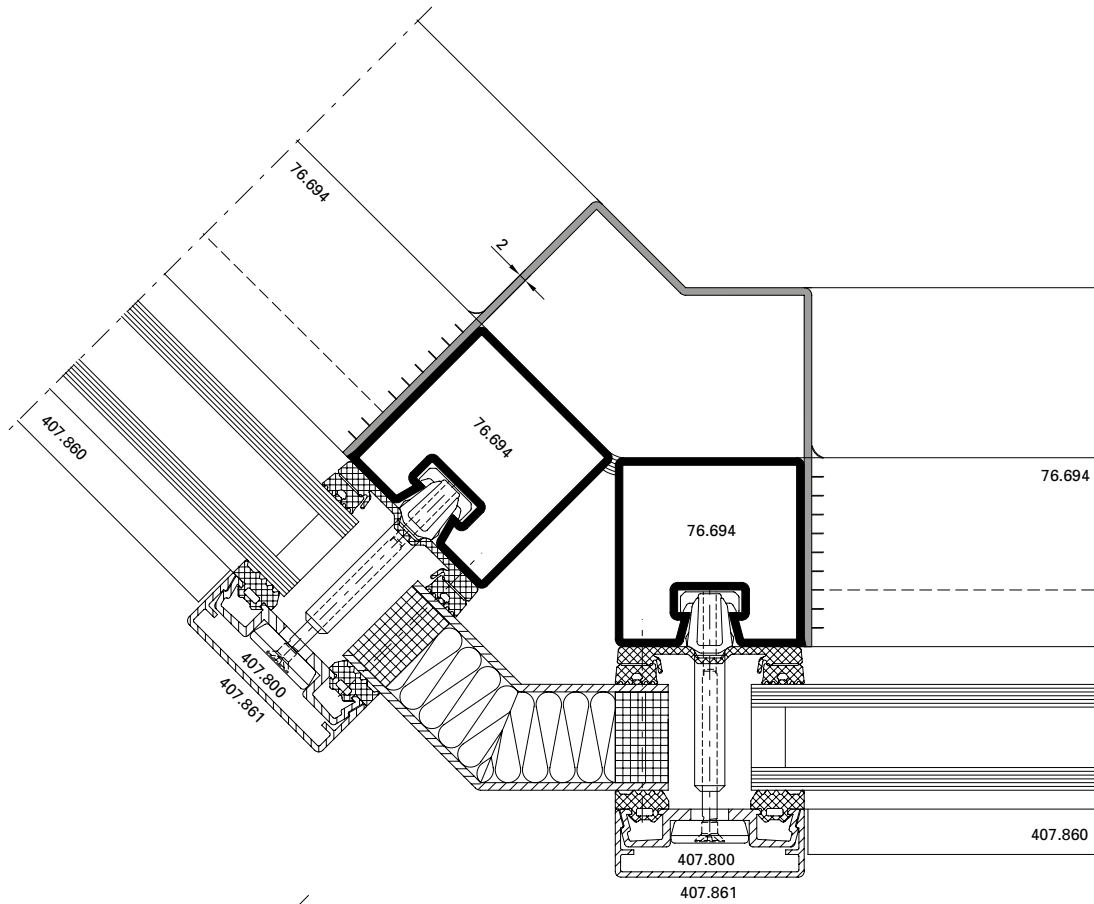

DXF DWG

D-510-K-003

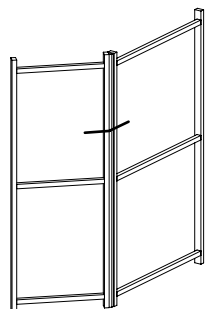
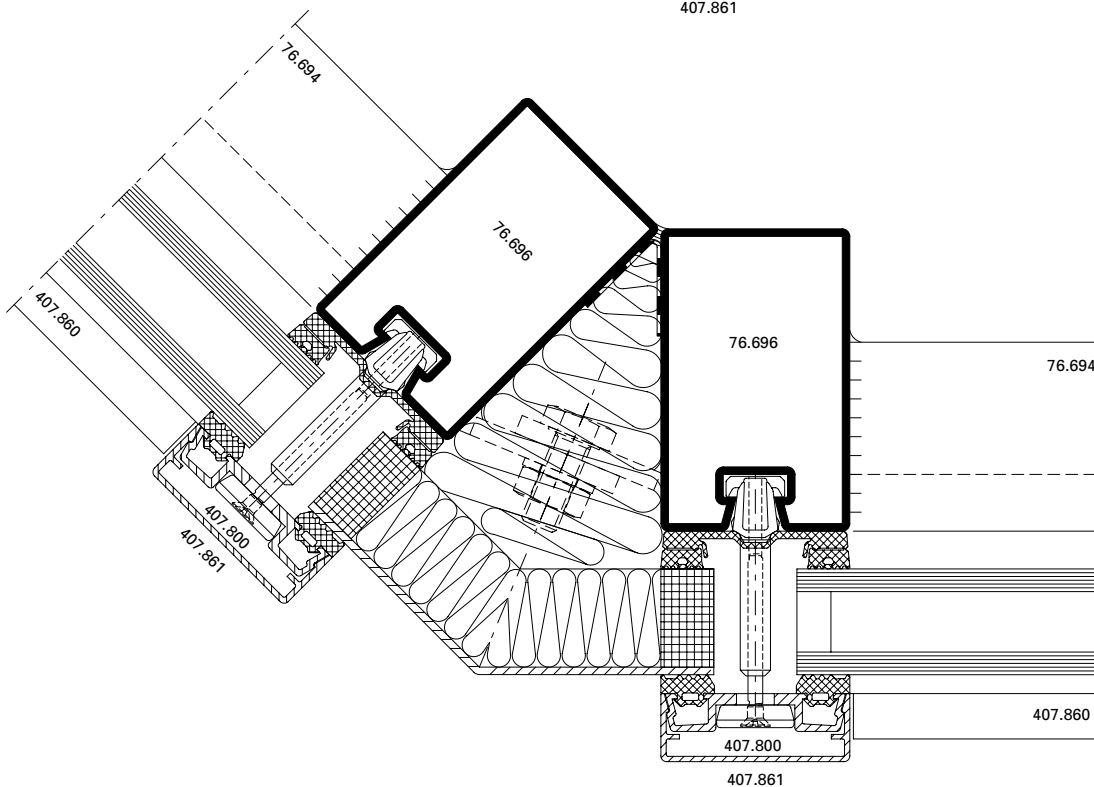

DXF DWG

D-510-K-004

Innenecke 135°

Angle intérieur 135°

Inner corner 135°

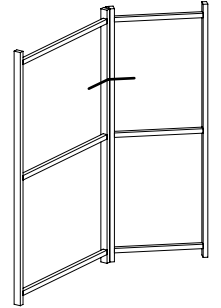
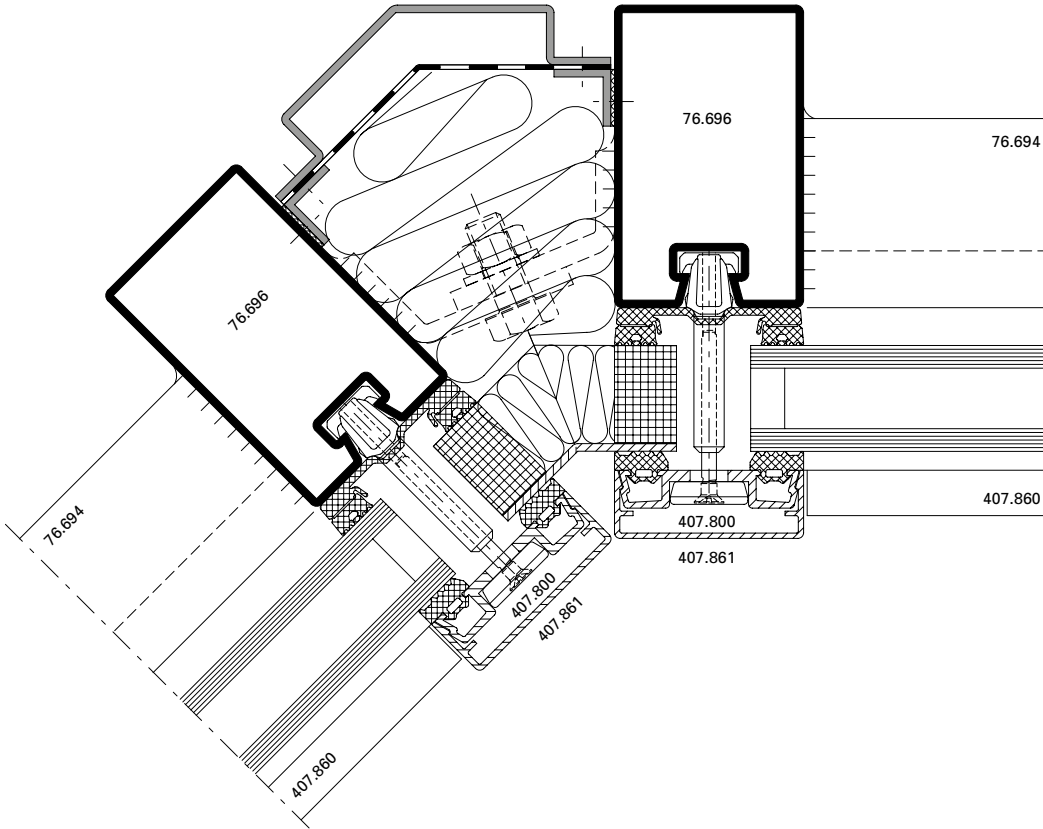

**DXF** **DWG**

D-510-K-009

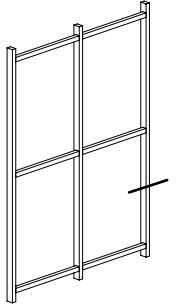
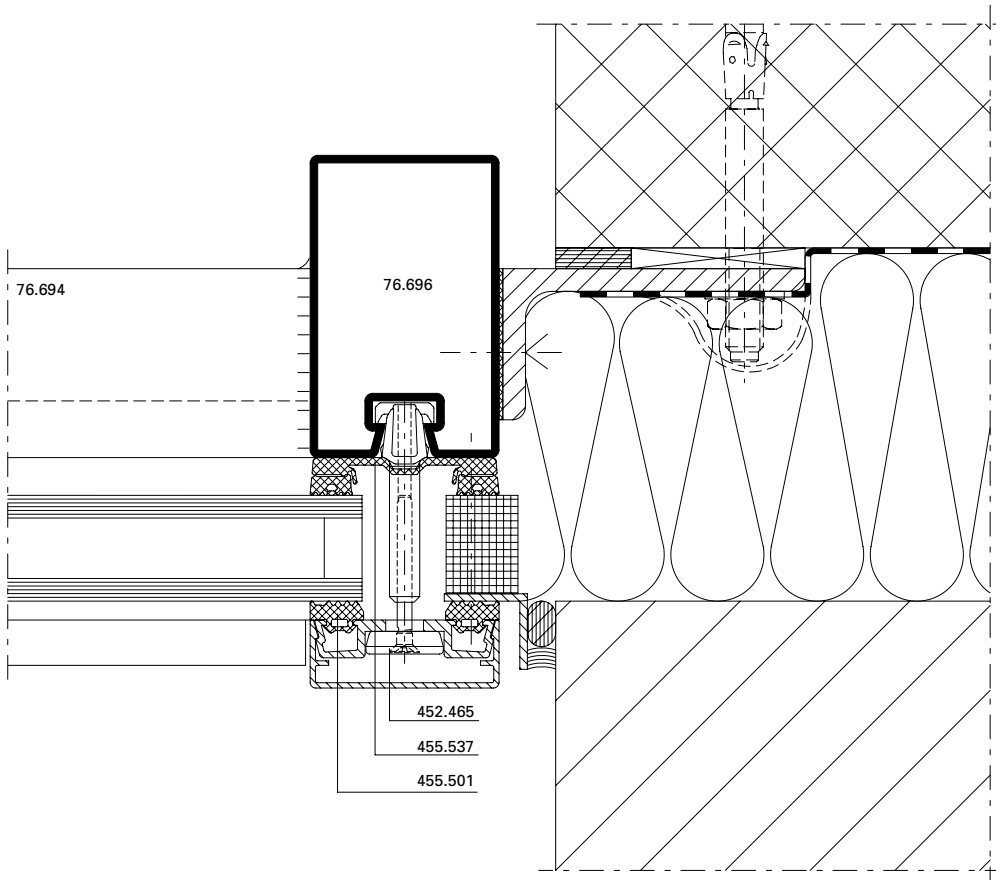

DXF DWG

D-510-A-001

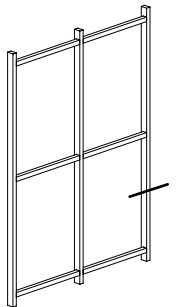
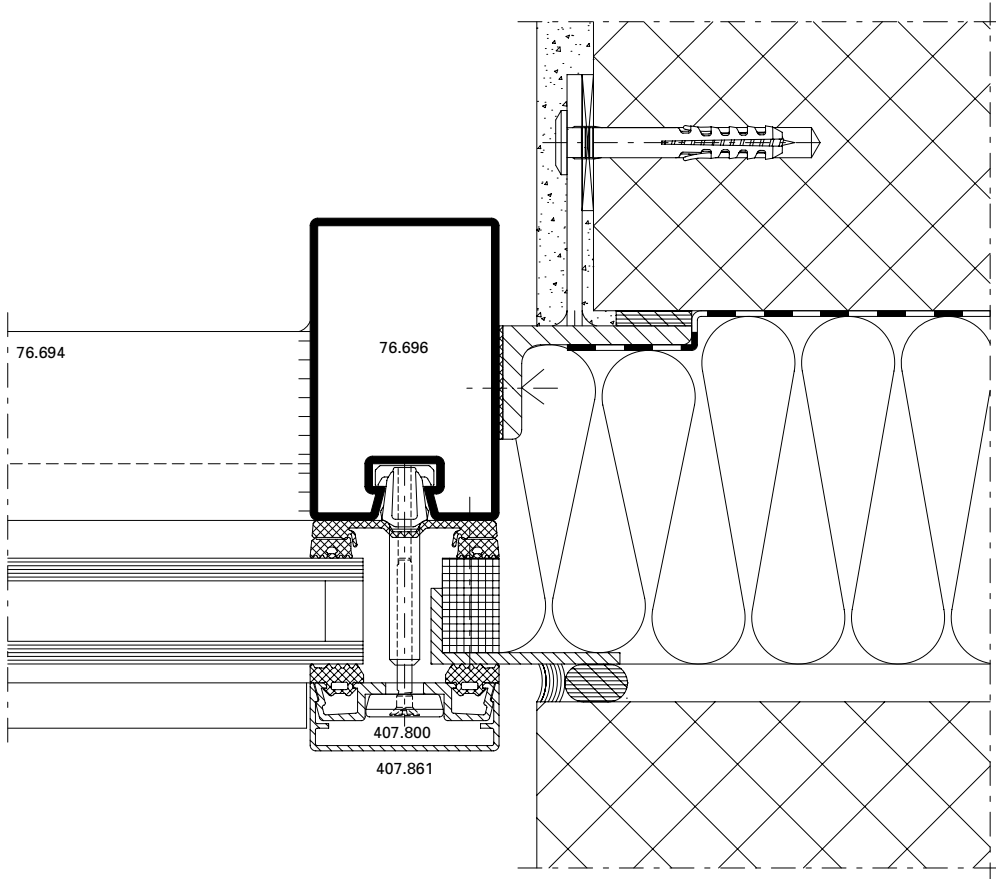

DXF DWG

D-510-A-002

Anschlüsse am Bau im Massstab 1:2  
Raccords au mur à l'échelle 1:2  
Attachment to structure on scale 1:2

VISS Fassade  
VISS façade  
VISS façade

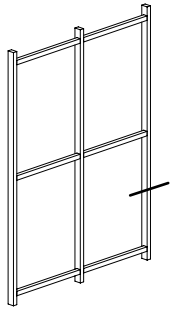
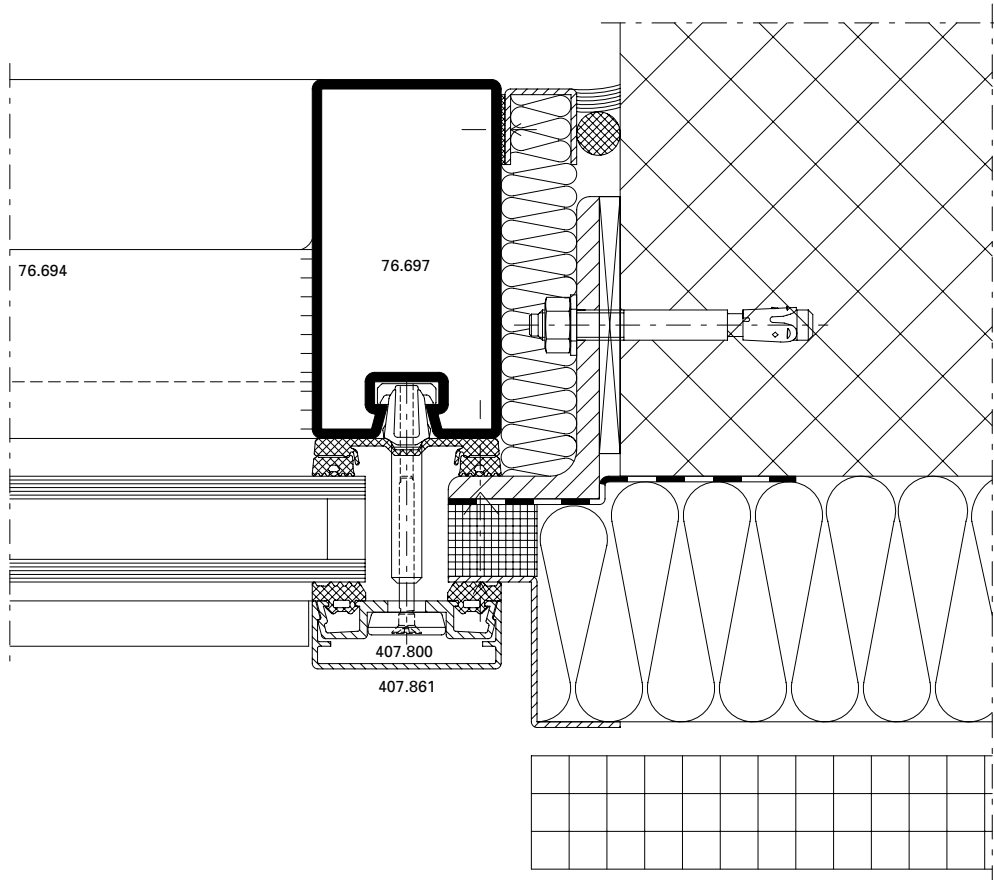

**DXF** **DWG**

D-510-A-003

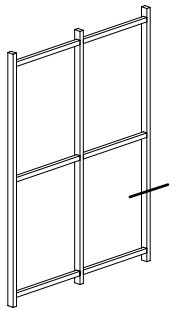
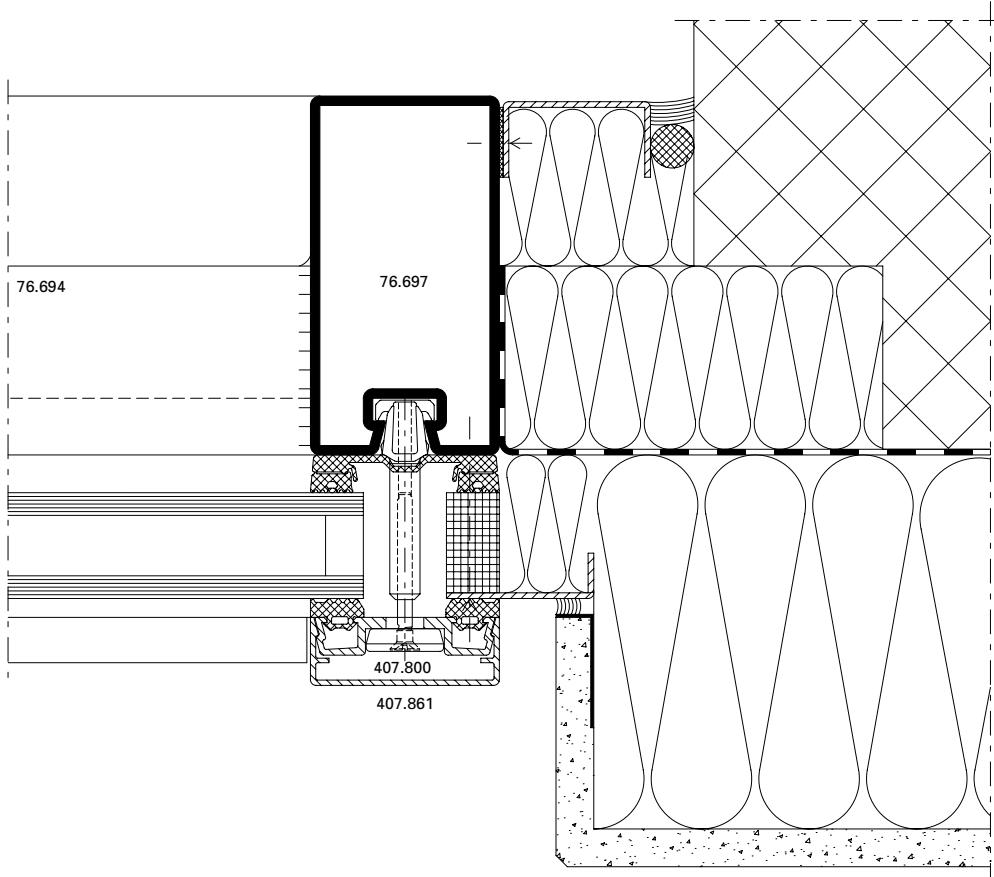

**DXF** **DWG**

D-510-A-004

Anschlüsse am Bau im Masstab 1:2  
Raccords au mur à l'échelle 1:2  
Attachment to structure on scale 1:2

VISS Fassade  
VISS façade  
VISS façade

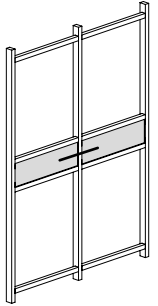
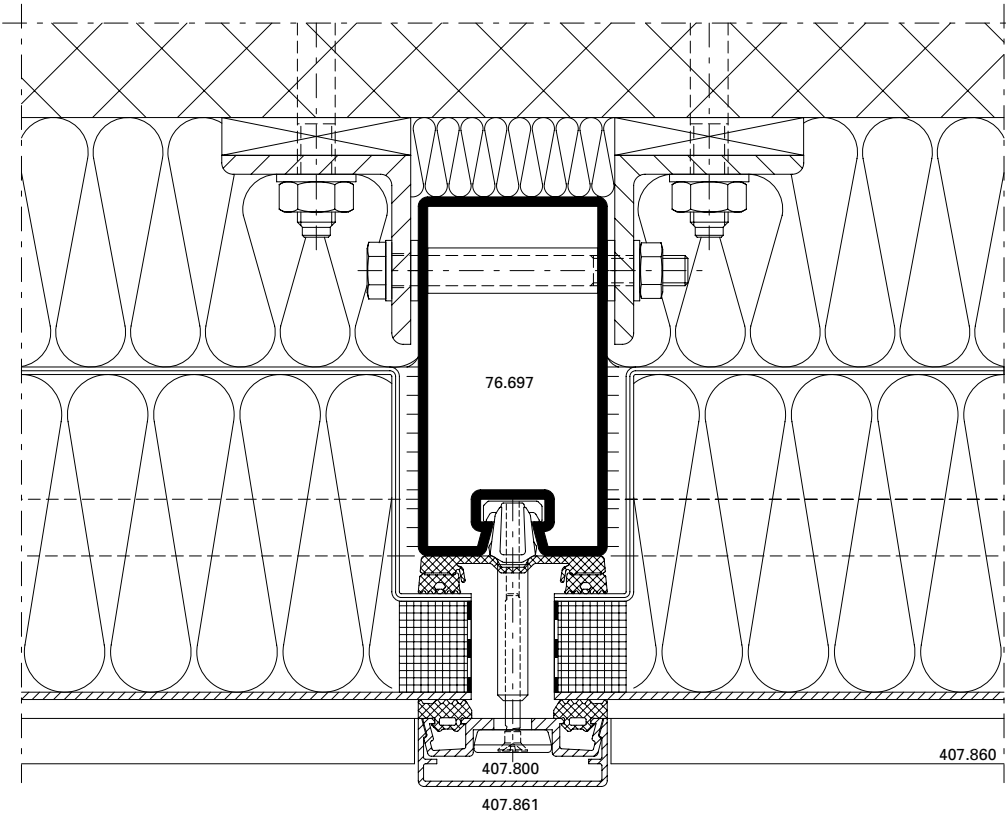

**DXF** **DWG**

*D-510-A-005*

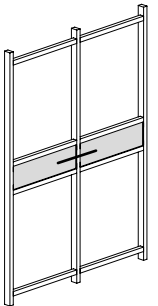
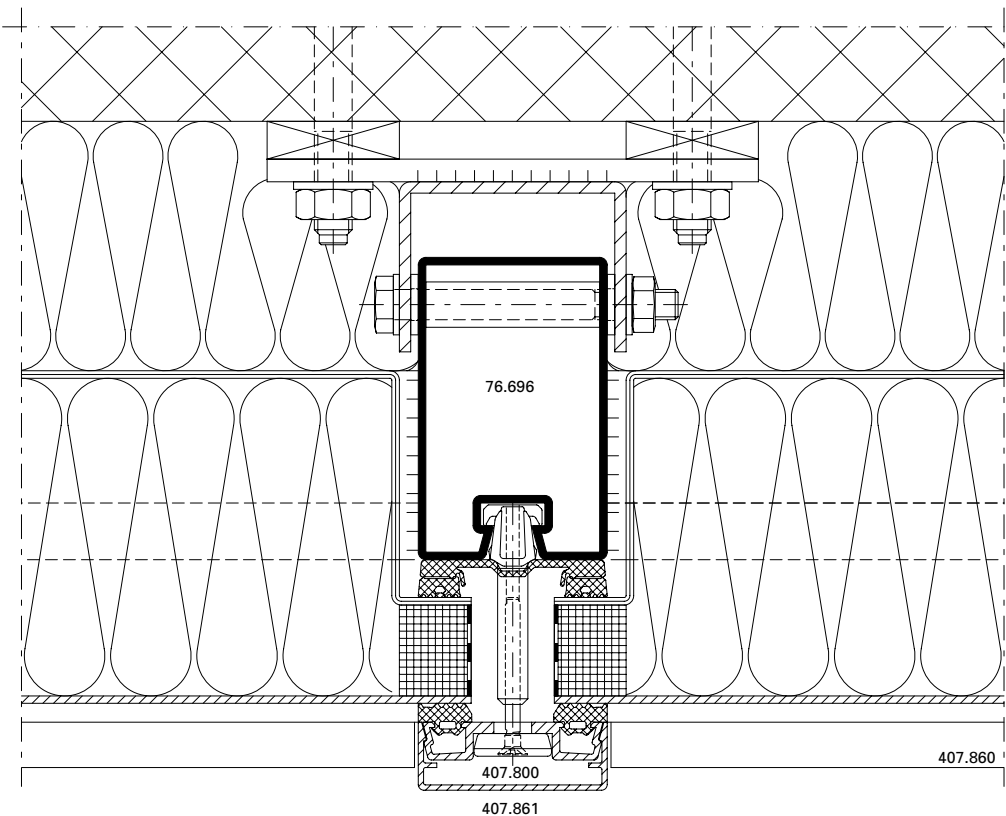

**DXF** **DWG**

*D-510-A-006*

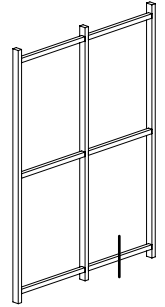
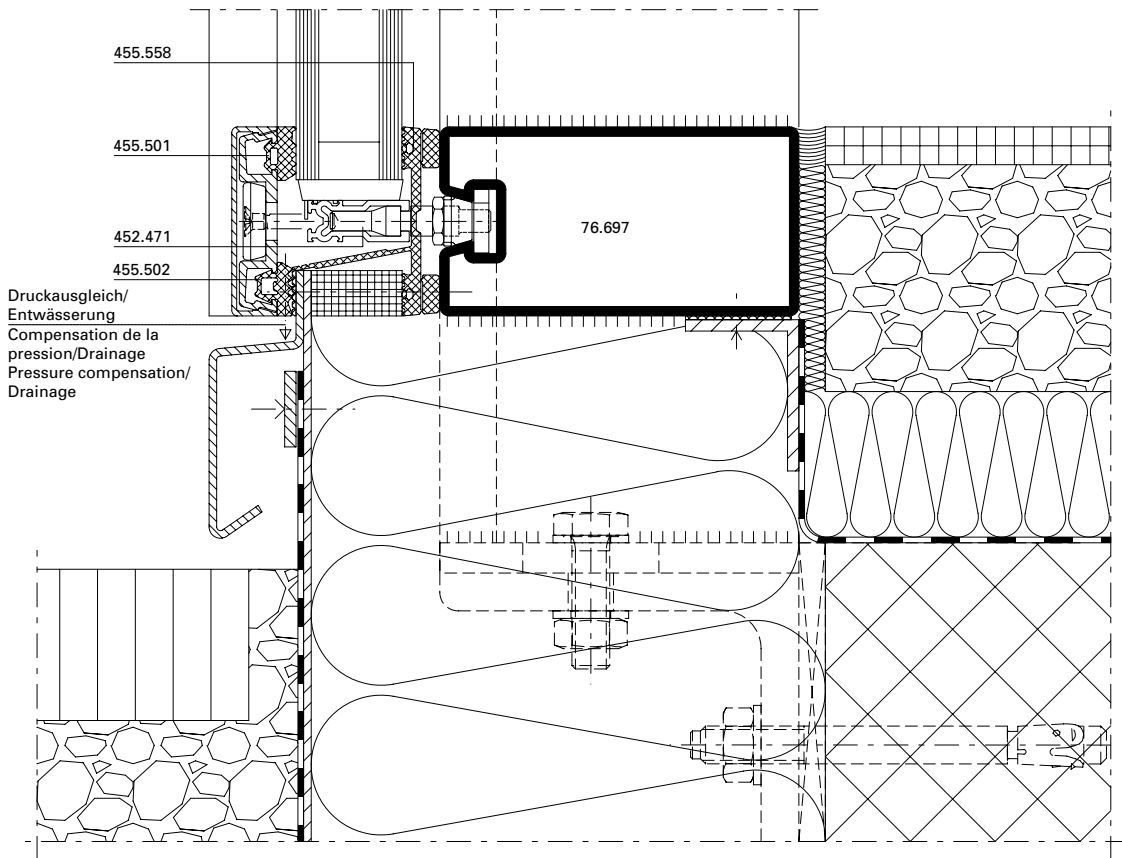

DXF DWG

D-510-A-007

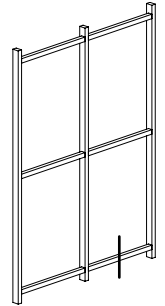
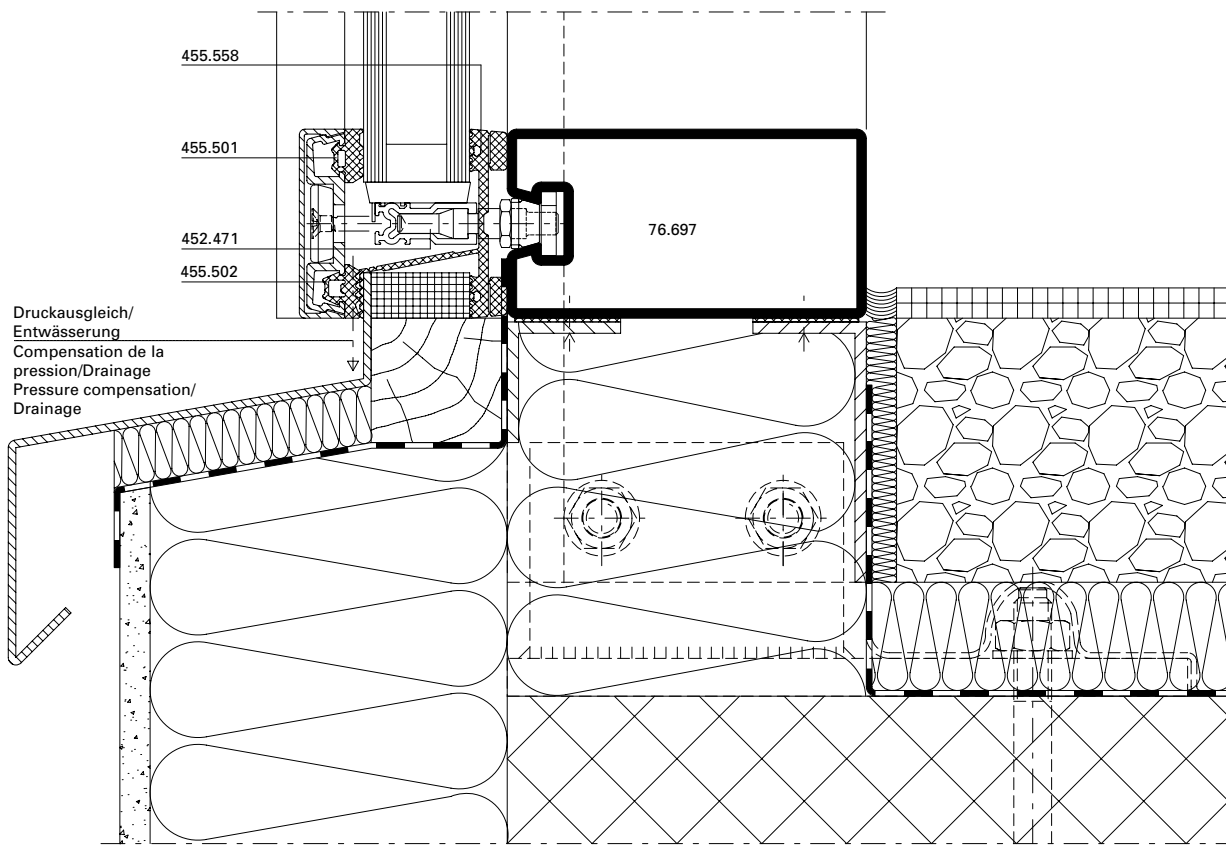

DXF DWG

D-510-A-008

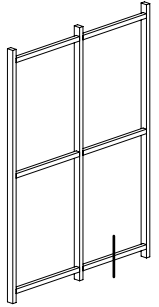
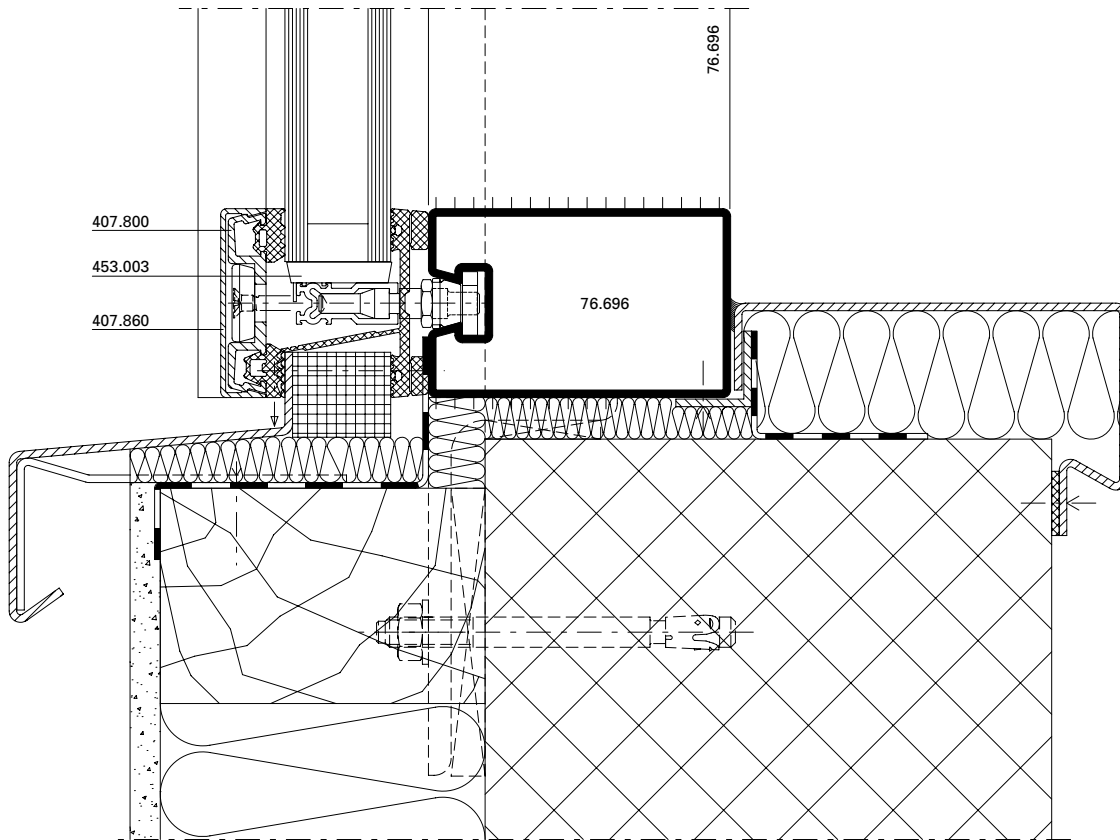

DXF DWG

D-510-A-009

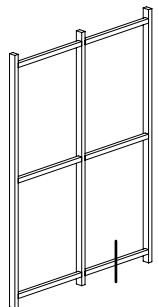
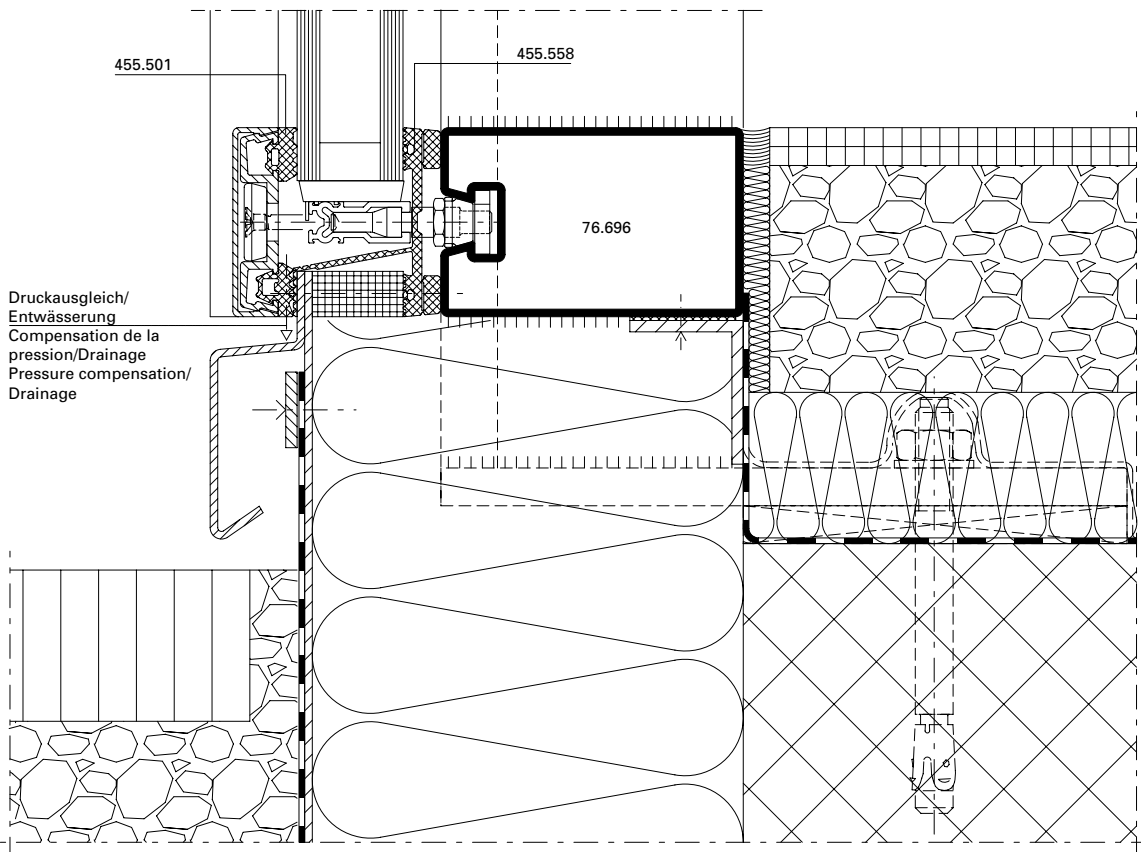

DXF DWG

D-510-A-010

Anschlüsse am Bau im Massstab 1:2

Raccords au mur à l'échelle 1:2

Attachment to structure on scale 1:2

VISS Fassade

VISS façade

VISS façade

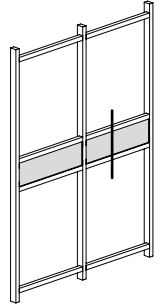
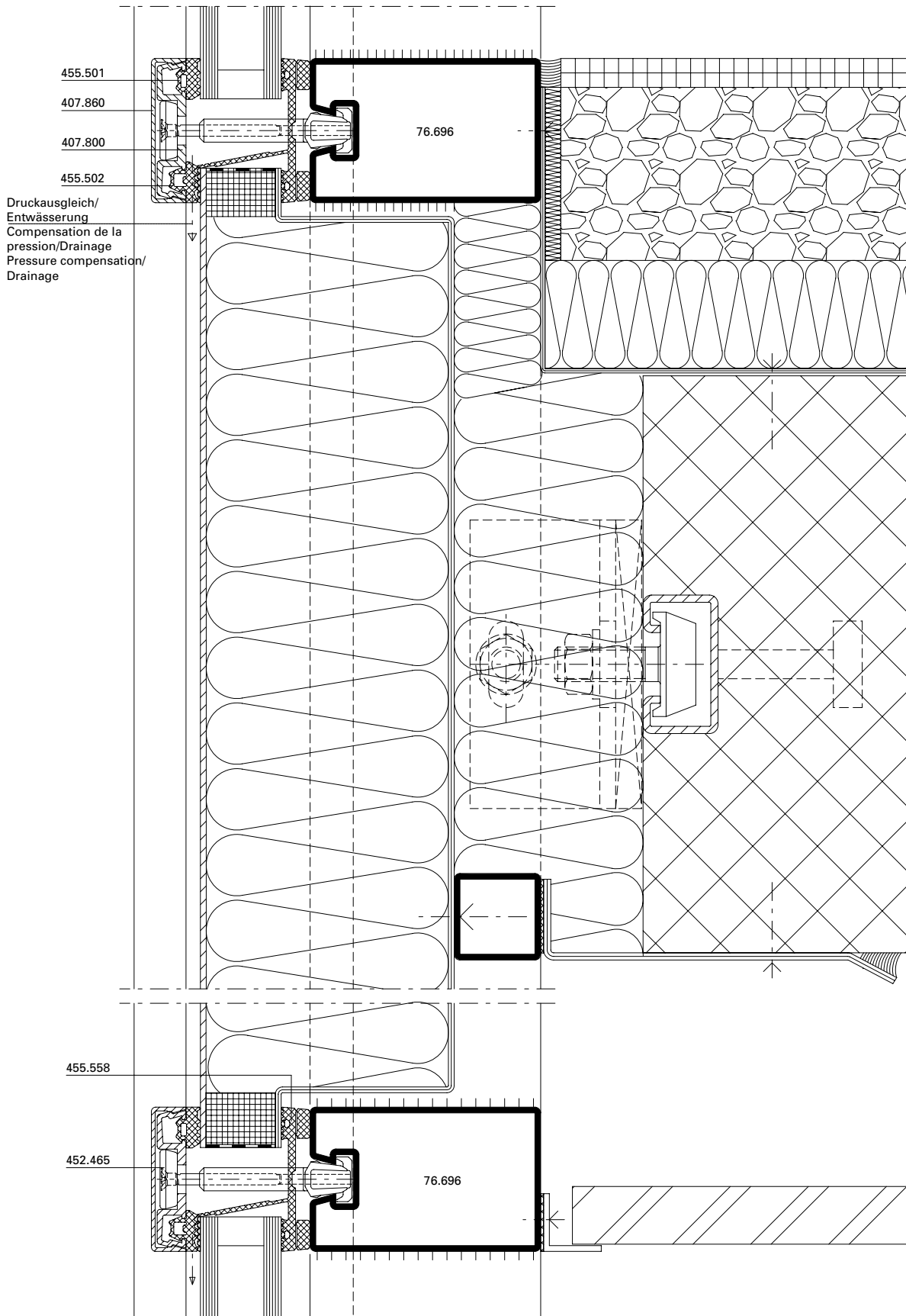

DXF DWG

D-510-A-011



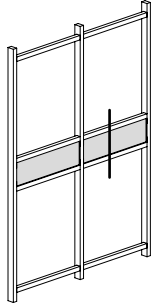
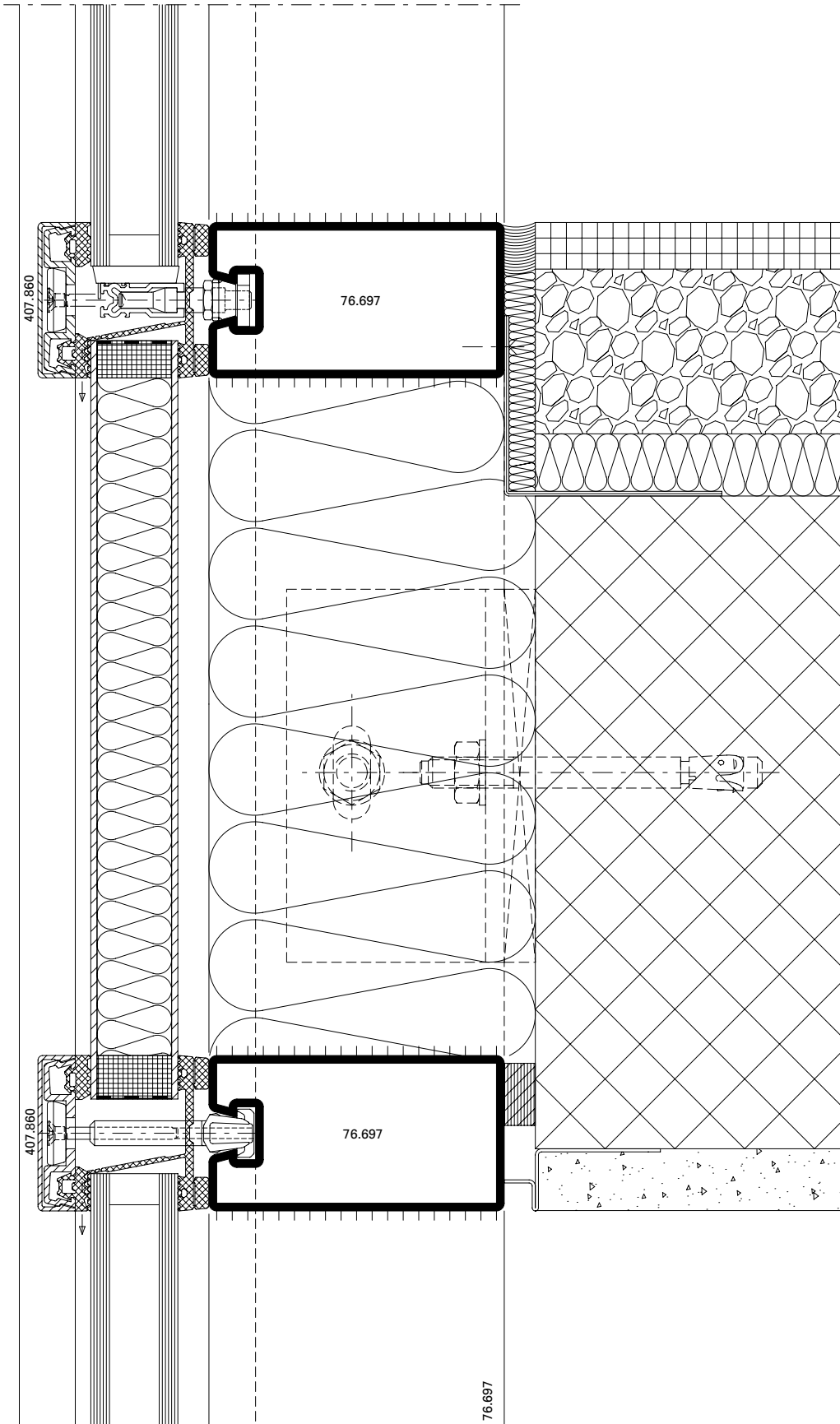

**DXF** **DWG**

D-510-A-012

Anschlüsse am Bau im Massstab 1:2  
Raccords au mur à l'échelle 1:2  
Attachment to structure on scale 1:2

VISS Fassade  
VISS façade  
VISS façade

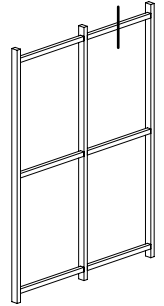
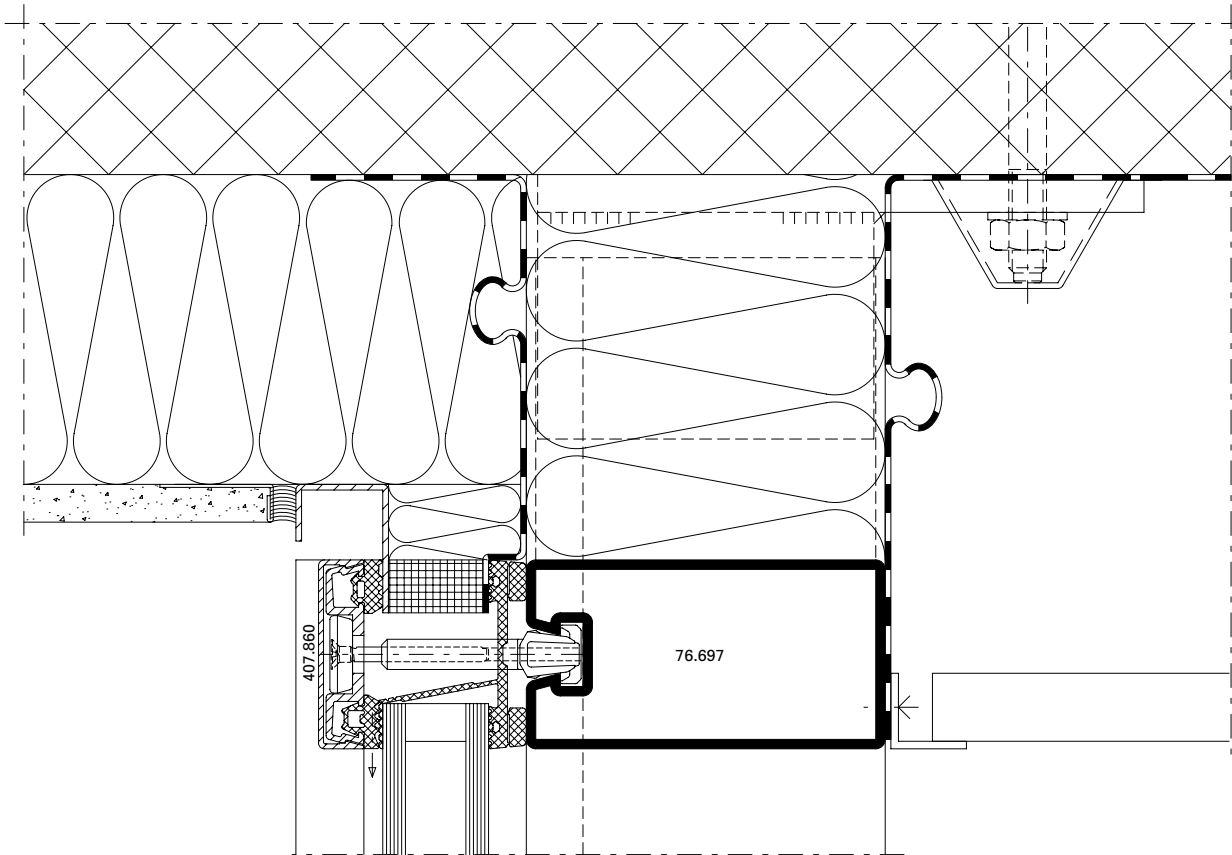

**DXF** **DWG**

D-510-A-013

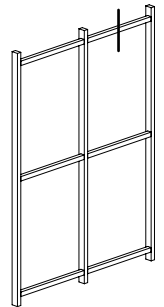
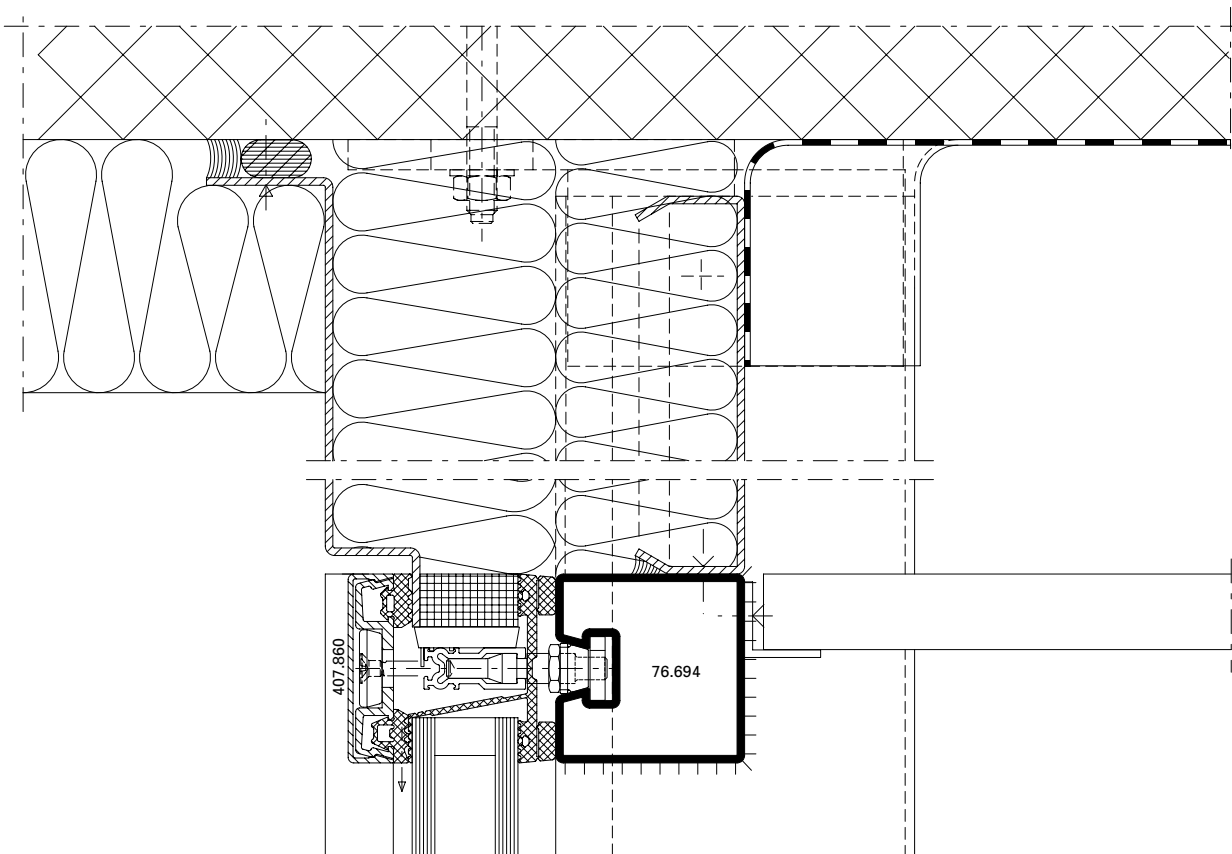

**DXF** **DWG**

D-510-A-014

Anschlüsse am Bau im Masstab 1:2  
Raccords au mur à l'échelle 1:2  
Attachment to structure on scale 1:2

VISS Fassade  
VISS façade  
VISS façade

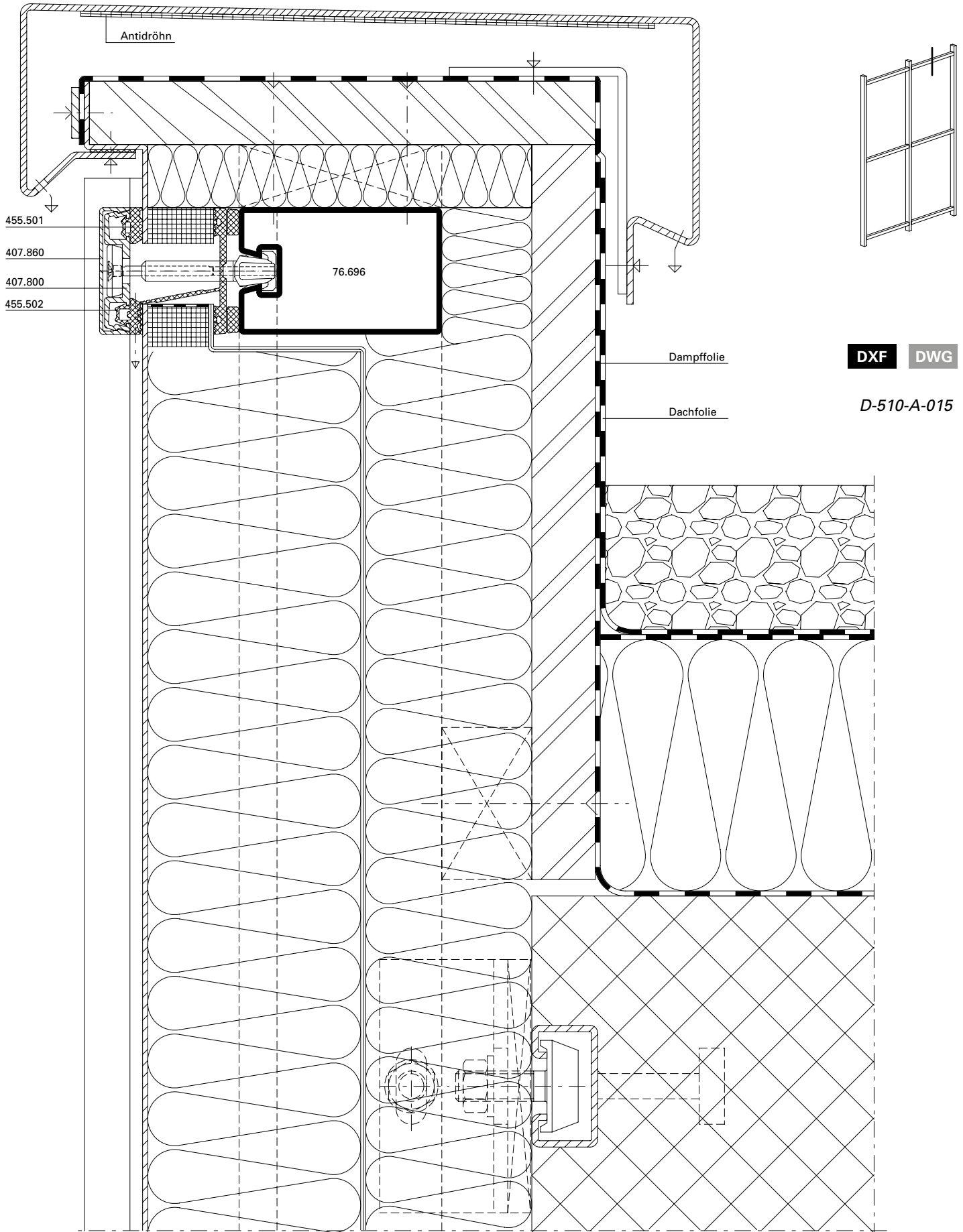

Sonnenschutz-Befestigung

Fixation pare-soleil

Sun protection fixation

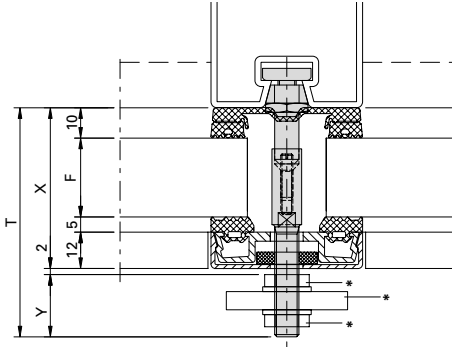

F	Anker Ancrage Anchor	Aufsatzbolzen Boulon de fixation Bolt	Deckprofil Profilé de recouvrement Cover section	X	Y	T	Fv N
6 - 14	452.550	452.557	12 mm	33 - 41	31 - 23	66	750
15 - 23	452.550			42 - 50	22 - 14	66	750
24 - 29	452.551			51 - 56	21 - 16	74	700
30 - 36	452.552			57 - 63	21 - 15	80	650
37 - 42	452.553			64 - 69	21 - 16	87	600
43 - 48	452.554			70 - 75	21 - 16	93	550

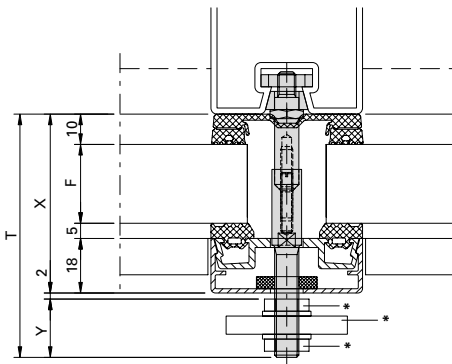

F	Anker Ancrage Anchor	Aufsatzbolzen Boulon de fixation Bolt	Deckprofil Profilé de recouvrement Cover section	X	Y	T	Fv N
6 - 14	452.550	452.557	18 mm	39 - 47	25 - 17	66	750
15 - 23	452.551			48 - 56	24 - 16	74	700
24 - 29	452.552			57 - 62	21 - 16	80	650
30 - 36	452.553			63 - 69	22 - 16	87	600
37 - 42	452.554			70 - 75	21 - 16	93	550
43 - 48	452.555			76 - 81	21 - 16	99	500

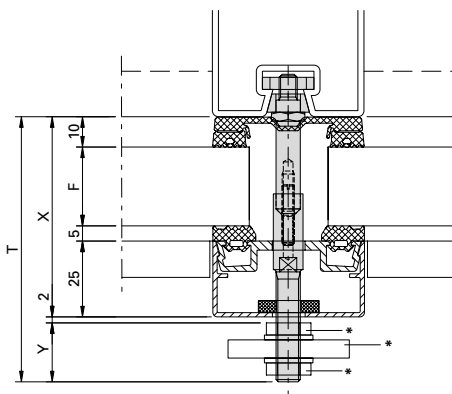

F	Anker Ancrage Anchor	Aufsatzbolzen Boulon de fixation Bolt	Deckprofil Profilé de recouvrement Cover section	X	Y	T	Fv N
6 - 14	452.551	452.557	25 mm	46 - 54	26 - 18	74	700
15 - 23	452.552			55 - 63	23 - 15	80	650
24 - 29	452.553			64 - 69	21 - 16	87	600
30 - 36	452.554			70 - 76	21 - 15	93	550
37 - 42	452.555			77 - 82	20 - 15	99	500
43 - 48	452.556			83 - 88	27 - 22	112	450

- \* Anschlussplatte und Inox-Muttern M8 bauseits (Mutter selbstsichernd oder mit Federscheibe gesichert)
- \* Plaque de raccordement et écrous Inox M8 au soin du métallier (écrous indesserrables ou bloqués par rondelle élastique)
- \* Connection plate and M8 stainless steel nuts by the contractor (self-locking nut, or secured with spring washer).

Sonnenschutz-Befestigung

Fixation pare-soleil

Sun protection fixation

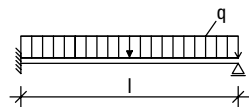
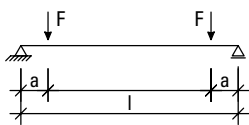
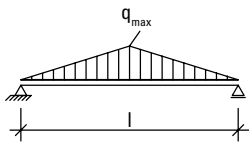
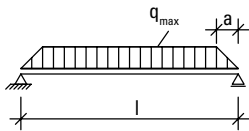
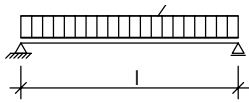

**Belastungsangaben**

**F<sub>v</sub>** = siehe Tabellen Seite 22-72

**F<sub>n</sub>** = 800 N (80 kg)

**F<sub>q</sub>** = 0

Gilt für paarweise eingesetzte Bolzen.

**Anzugsmoment:**

Anker 4 Nm

Aufsatzbolzen 2,5 Nm

**Indications de charge**

**F<sub>v</sub>** = voir tableaux page 22-72

**F<sub>n</sub>** = 800 N (80 kg)

**F<sub>q</sub>** = 0

Valables pour boulons montés par paires.

**Couple de serrage::**

Ancrage 4 Nm

Boulon de fixation 2,5 Nm

**Load specifications**

**F<sub>v</sub>** = see tables, page 22-72

**F<sub>n</sub>** = 800 N (80 kg)

**F<sub>q</sub>** = 0

Applies for bolts inserted in pairs.

**Tightening torque:**

Anchor 4 Nm

Bolt 2.5 Nm

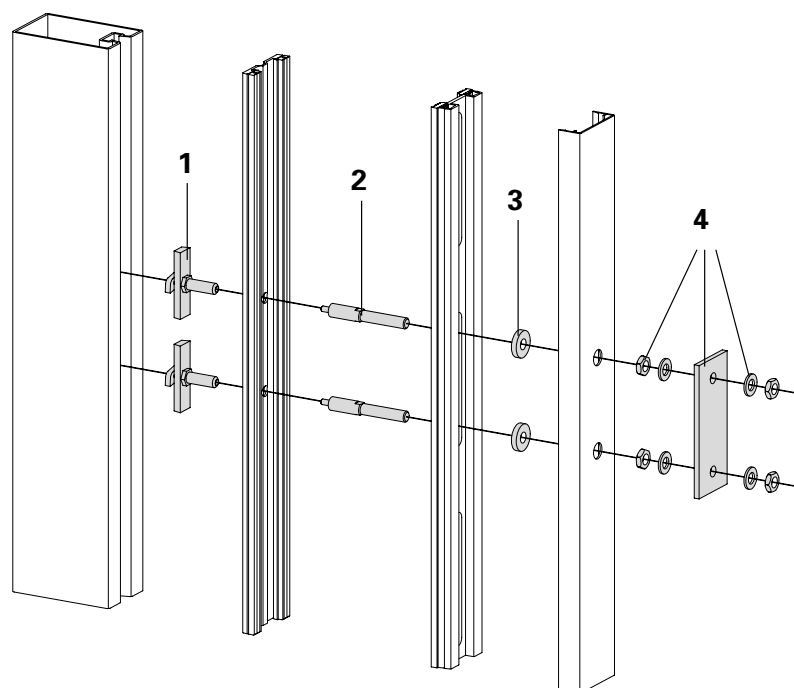

- 1 Anker (452.550-452.556)
- 2 Aufsatzbolzen (452.557)
- 3 Dichtring (aus 452.557)
- 4 Befestigungsplatte (bauseits)

- 1 Ancrage (452.550-452.556)
- 2 Boulon de fixation (452.557)
- 3 Bague d'étanchéité (de 452.557)
- 4 Plaque de fixation (au soin du métallier)

- 1 Anchor (452.550-452.556)
- 2 Bolt (452.557)
- 3 Gasket (from 452.557)
- 4 Fastening plate (customer-supplied)

Stossausbildungen Innendichtung

Jonctions joint intérieur

Inner gasket junctions

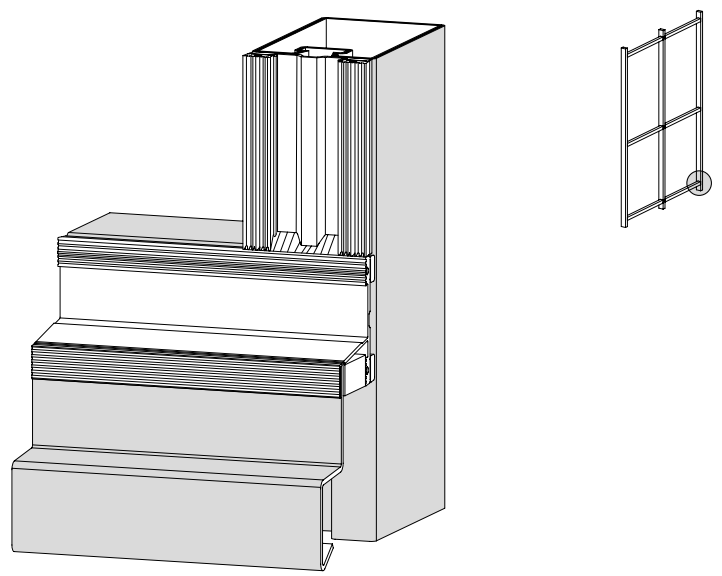
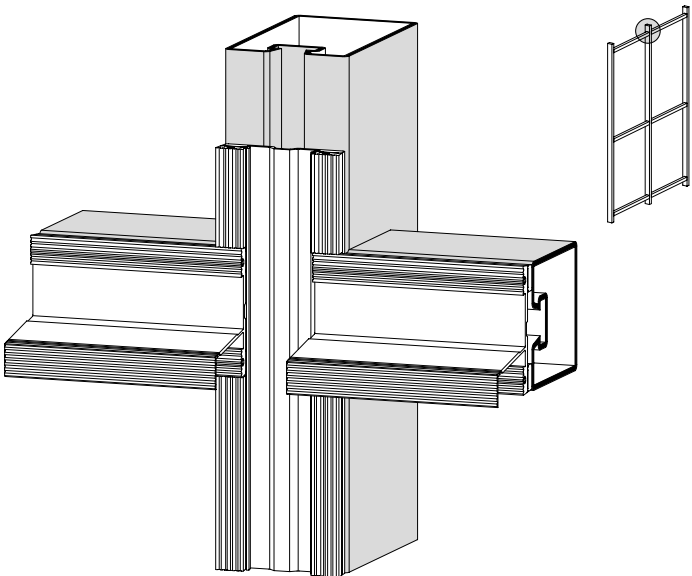
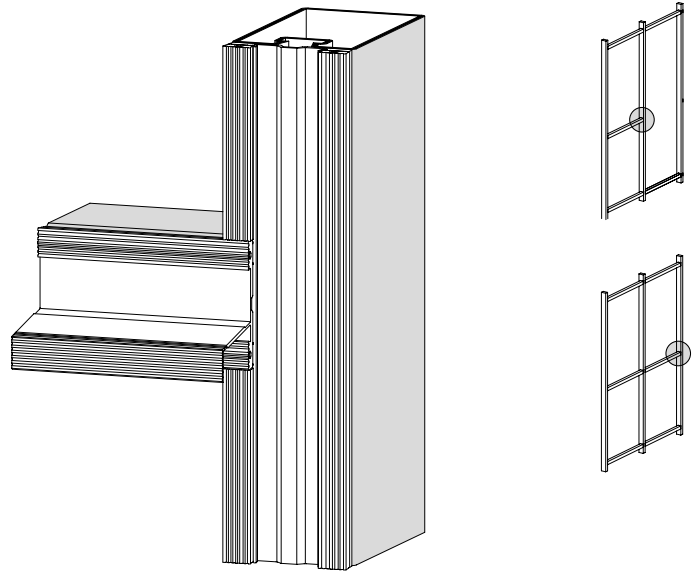
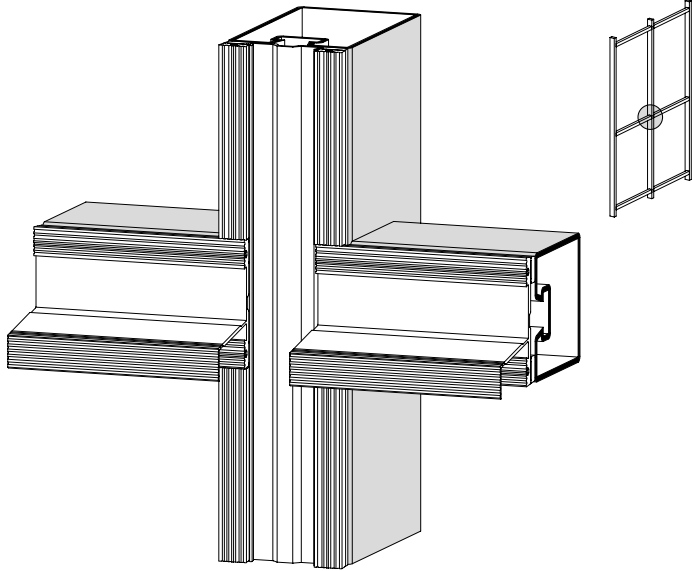

**Stossausbildungen Innendichtung**

**Jonctions joint intérieure**

**Inner gasket junctions**

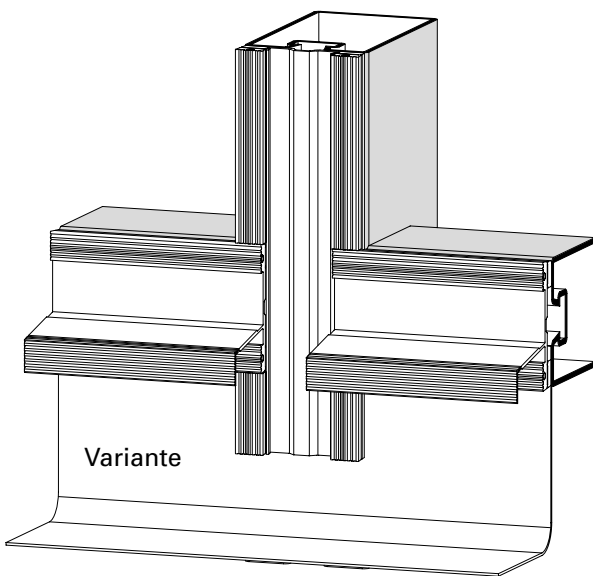
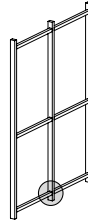
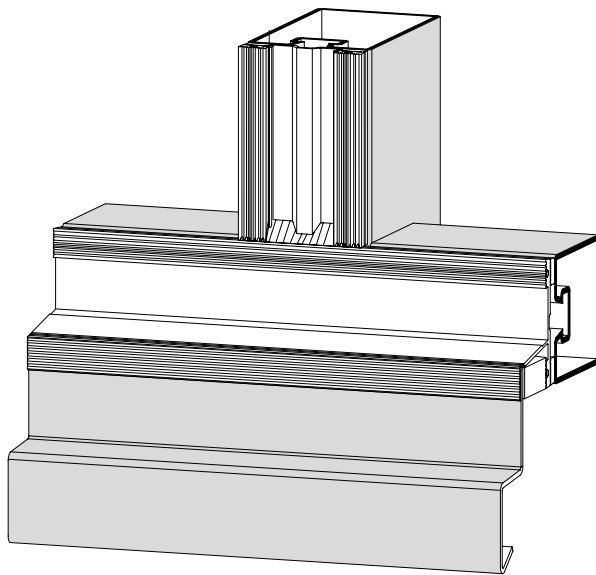

Glaseinstand

Prise en feuillure

Glass edge cover

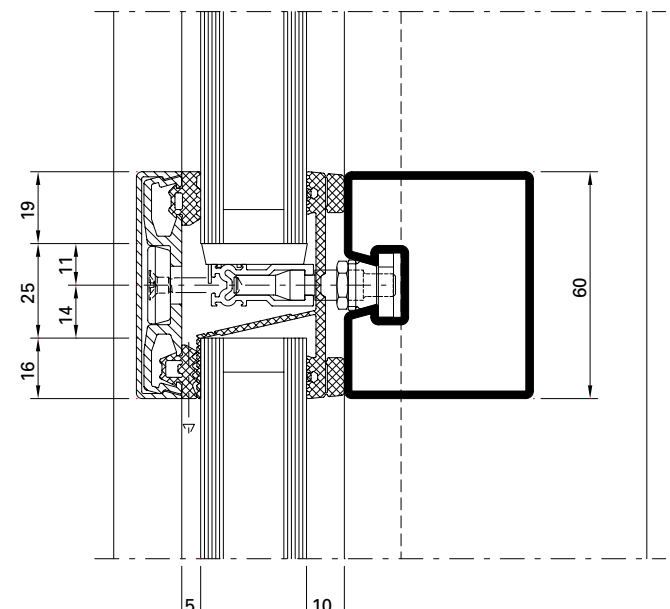
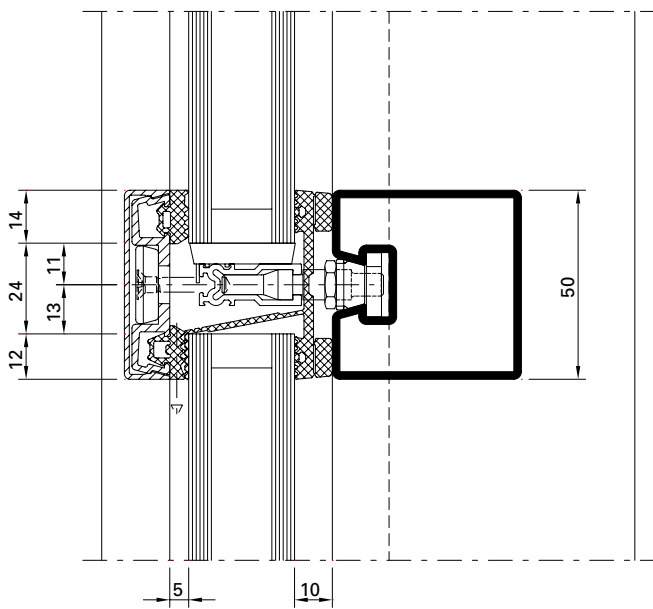
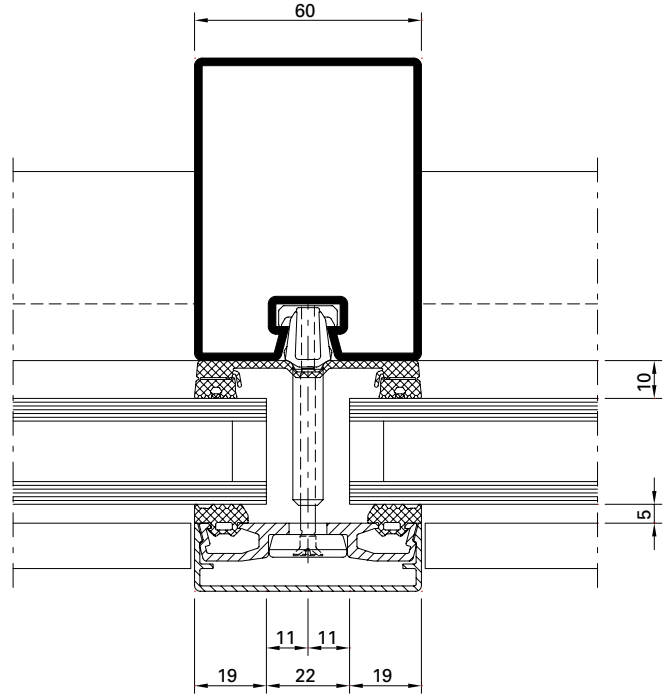
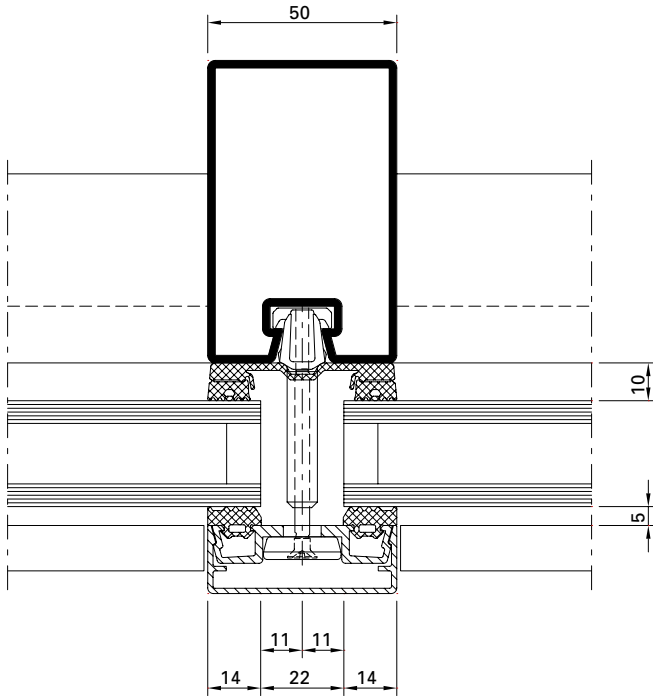

Verlangen Sie für die  
 Verarbeitung und Montage  
 der VISS-Systeme unsere  
 ausführlichen Verarbeitungs-  
 und Montage-Richtlinien.

Demandez notre brochure  
 détaillée sur les directives  
 d'usinage et de montage  
 du systèmes VISS.

For processing and assembling  
 the VISS systems, ask for our  
 detailed Fabrication and  
 Assembly Instructions.



**Glaseinstand**  
**Flaches Deckprofil**

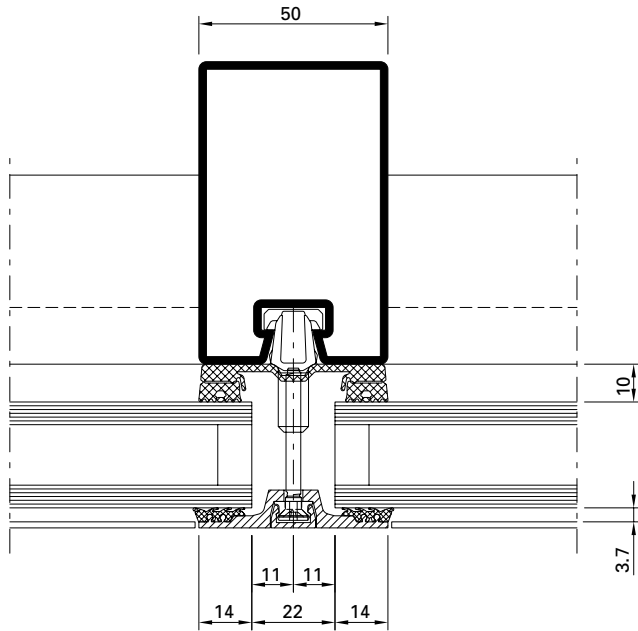

**Prise en feuillure**  
**Profilé de recouvrement plat**

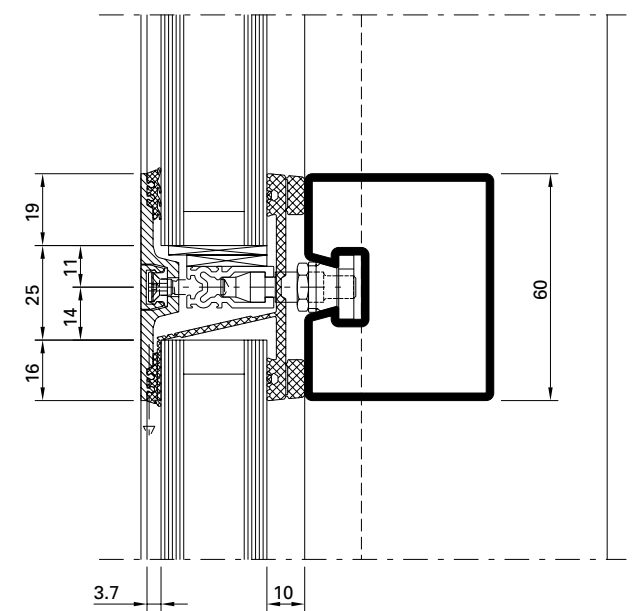
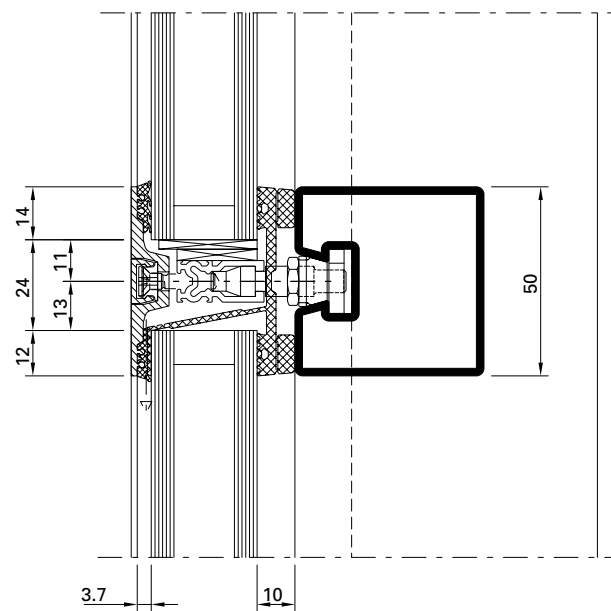
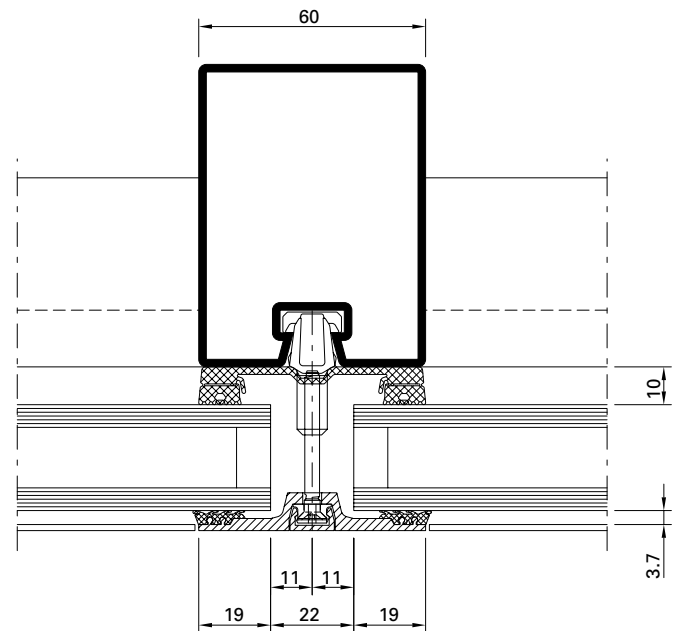

Glasfalz-Belüftung/  
Glasfalz-Entwässerung

Ventilation de feuillures de verre/  
Drainage de la feuillure à verre

Glazing rebate ventilation /  
Glazing rebate drainage

Detail 1

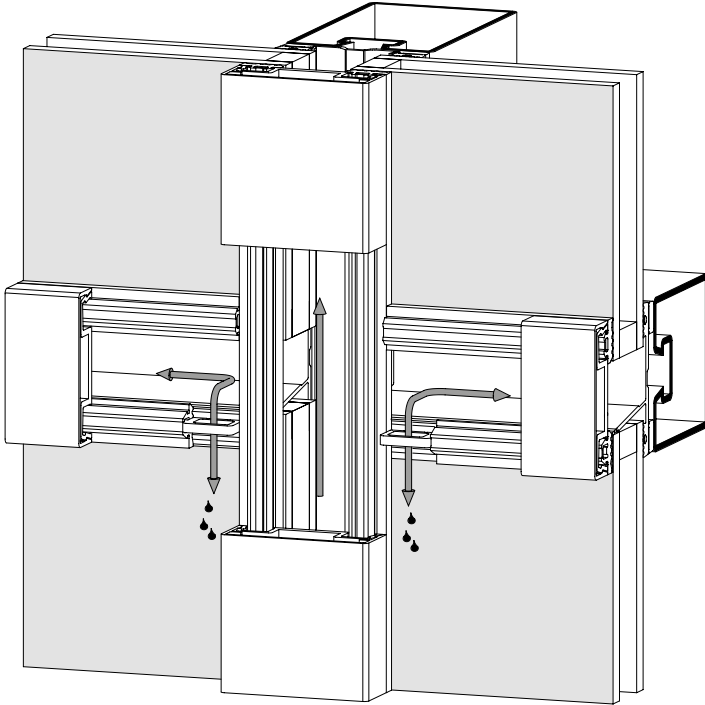

Detail 2

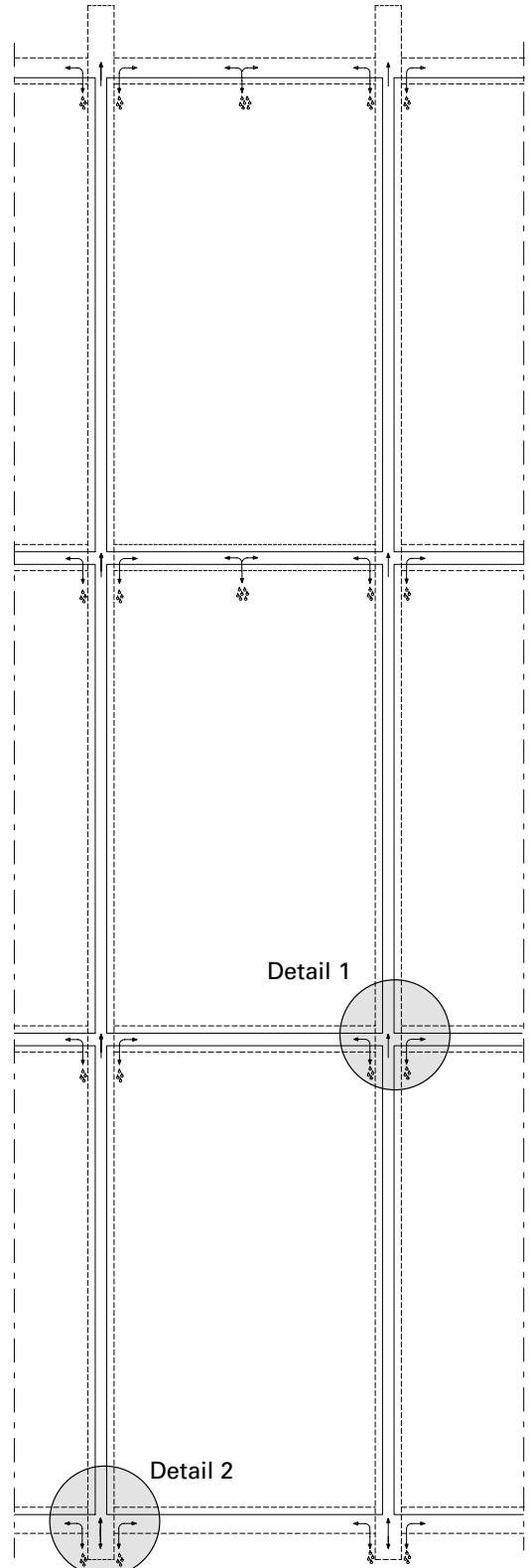
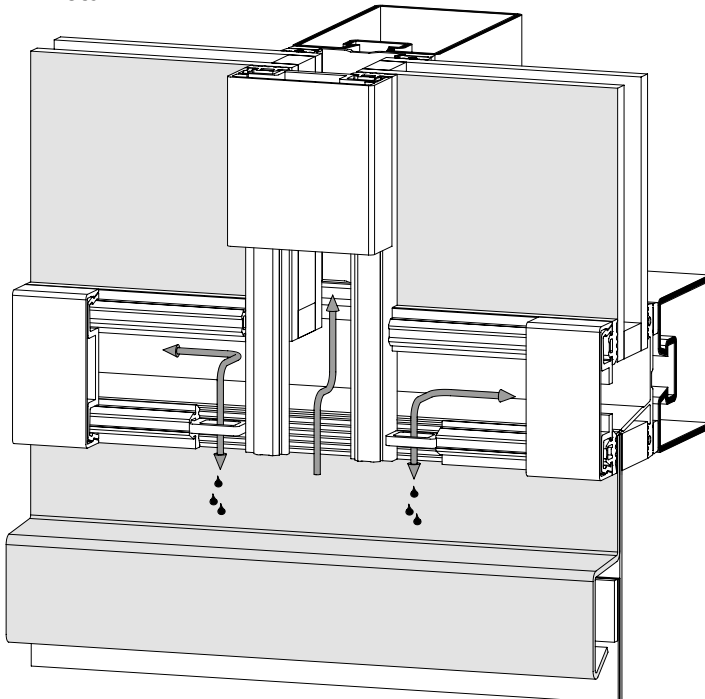

**Glasfalz-Belüftung/  
Glasfalz-Entwässerung**

**Ventilation de feuillures de verre/  
Drainage de la feuillure à verre**

**Glazing rebate ventilation /  
Glazing rebate drainage**

Detail 3

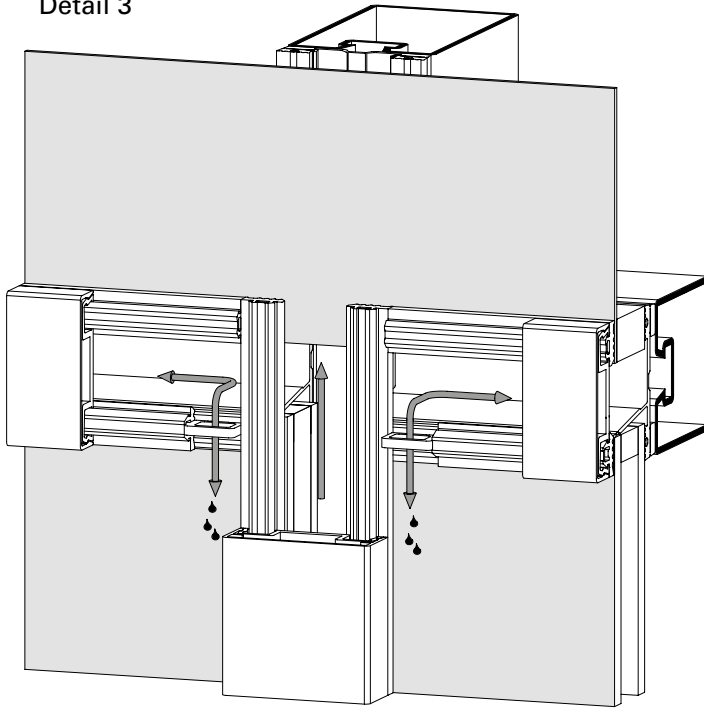

Detail 4

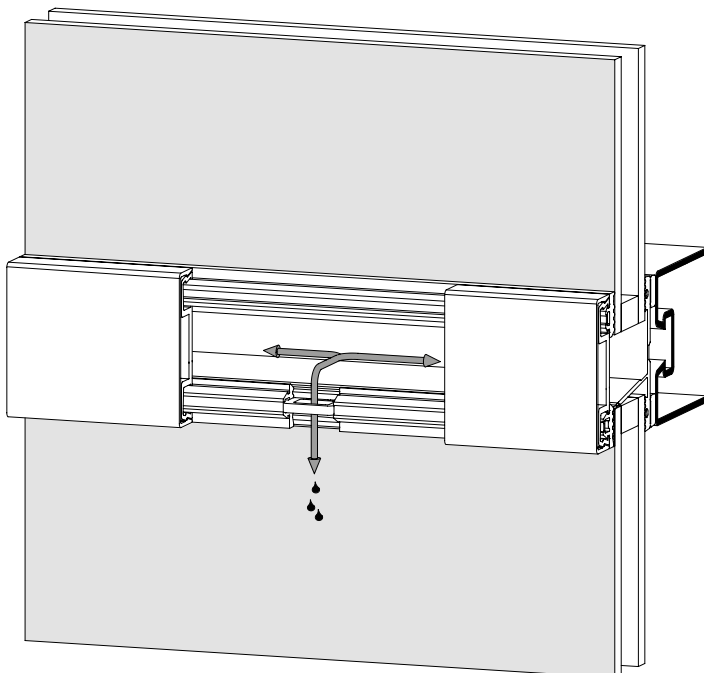

Detail 3

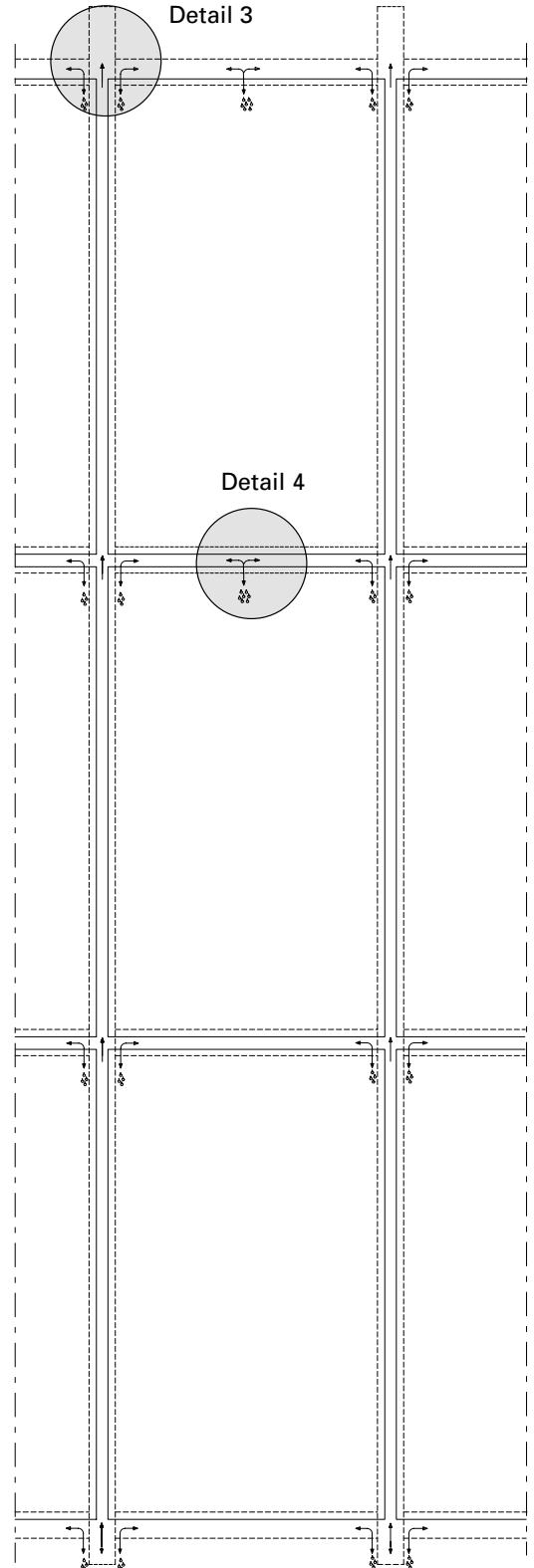

Detail 4

**System-Hinweise**

Remarques concernant les systèmes

System instructions

VISS Fassade

VISS façade

VISS façade

**VISS HI 50 mm  
mit Dämmprofil**

**U<sub>f</sub>-Werte nach EN 10077-2**

**VISS HI 50 mm  
avec gaine isolante**

**Valeurs U<sub>f</sub> selon EN 10077-2**

**VISS HI 50 mm  
with insulating core**

**U<sub>f</sub> values according to 10077-2**

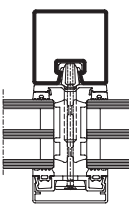
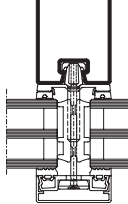
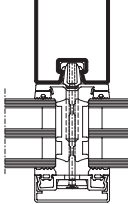
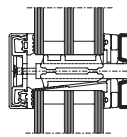
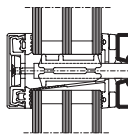
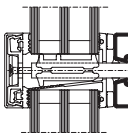
						
<b>Glas Verre Glass</b>	Pfosten 50/50 Montant 50/50 Mullion 50/50	Pfosten 50/120 Montant 50/129 Mullion 50/120	Pfosten 50/140 Montant 50/140 Mullion 50/140	Riegel 50/50 Traverse 50/50 Transom 50/50	Riegel 50/120 Traverse 50/120 Transom 50/120	Riegel 50/140 Traverse 50/140 Transom 50/140
30 mm	<b>0,94 W/m<sup>2</sup>K</b>	<b>0,96 W/m<sup>2</sup>K</b>	<b>0,97 W/m<sup>2</sup>K</b>	<b>1,0 W/m<sup>2</sup>K</b>	<b>1,0 W/m<sup>2</sup>K</b>	<b>1,0 W/m<sup>2</sup>K</b>
40 mm	<b>0,77 W/m<sup>2</sup>K</b>	<b>0,79 W/m<sup>2</sup>K</b>	<b>0,79 W/m<sup>2</sup>K</b>	<b>0,85 W/m<sup>2</sup>K</b>	<b>0,86 W/m<sup>2</sup>K</b>	<b>0,86 W/m<sup>2</sup>K</b>
50 mm	<b>0,64 W/m<sup>2</sup>K</b>	<b>0,65 W/m<sup>2</sup>K</b>	<b>0,65 W/m<sup>2</sup>K</b>	<b>0,73 W/m<sup>2</sup>K</b>	<b>0,74 W/m<sup>2</sup>K</b>	<b>0,74 W/m<sup>2</sup>K</b>
60 mm	<b>0,58 W/m<sup>2</sup>K</b>	<b>0,59 W/m<sup>2</sup>K</b>	<b>0,59 W/m<sup>2</sup>K</b>	<b>0,65 W/m<sup>2</sup>K</b>	<b>0,66 W/m<sup>2</sup>K</b>	<b>0,66 W/m<sup>2</sup>K</b>
70 mm	<b>0,53 W/m<sup>2</sup>K</b>	<b>0,53 W/m<sup>2</sup>K</b>	<b>0,53 W/m<sup>2</sup>K</b>	<b>0,60 W/m<sup>2</sup>K</b>	<b>0,60 W/m<sup>2</sup>K</b>	<b>0,60 W/m<sup>2</sup>K</b>

Der Einfluss der Schraubenbefestigung in Höhe von 0.14 W/m<sup>2</sup>K ist berücksichtigt.

L'influence de la fixation à vis de 0.14 W/m<sup>2</sup>K est prise en compte.

The 0.14 W/m<sup>2</sup>K influence of the screw fixing is taken into account.

**System-Hinweise**

Remarques concernant les systèmes

System instructions

VISS Fassade

VISS façade

VISS façade

**VISS HI 60 mm  
mit Dämmprofil**

**U<sub>f</sub>-Werte nach EN 10077-2**

**VISS HI 60 mm  
avec gaine isolante**

**Valeurs U<sub>f</sub> selon EN 10077-2**

**VISS HI 60 mm  
with insulating core**

**U<sub>f</sub> values according to 10077-2**

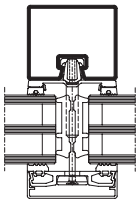
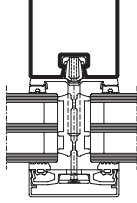
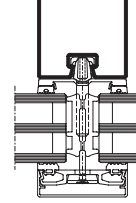
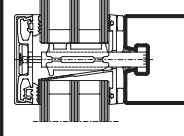
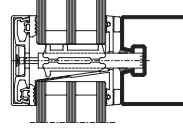
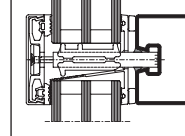
						
<b>Glas Verre Glass</b>	Pfosten 60/50 Montant 60/50 Mullion 60/50	Pfosten 60/100 Montant 60/100 Mullion 60/100	Pfosten 60/150 Montant 60/150 Mullion 60/150	Riegel 60/50 Traverse 60/50 Transom 60/50	Riegel 60/100 Traverse 60/100 Transom 60/100	Riegel 60/150 Traverse 60/150 Transom 60/150
30 mm	<b>0,92 W/m<sup>2</sup>K</b>	<b>0,94 W/m<sup>2</sup>K</b>	<b>0,95 W/m<sup>2</sup>K</b>	<b>0,97 W/m<sup>2</sup>K</b>	<b>0,98 W/m<sup>2</sup>K</b>	<b>0,99 W/m<sup>2</sup>K</b>
40 mm	<b>0,75 W/m<sup>2</sup>K</b>	<b>0,76 W/m<sup>2</sup>K</b>	<b>0,76 W/m<sup>2</sup>K</b>	<b>0,82 W/m<sup>2</sup>K</b>	<b>0,84 W/m<sup>2</sup>K</b>	<b>0,84 W/m<sup>2</sup>K</b>
50 mm	<b>0,62 W/m<sup>2</sup>K</b>	<b>0,63 W/m<sup>2</sup>K</b>	<b>0,63 W/m<sup>2</sup>K</b>	<b>0,70 W/m<sup>2</sup>K</b>	<b>0,71 W/m<sup>2</sup>K</b>	<b>0,72 W/m<sup>2</sup>K</b>
60 mm	<b>0,55 W/m<sup>2</sup>K</b>	<b>0,56 W/m<sup>2</sup>K</b>	<b>0,56 W/m<sup>2</sup>K</b>	<b>0,63 W/m<sup>2</sup>K</b>	<b>0,64 W/m<sup>2</sup>K</b>	<b>0,64 W/m<sup>2</sup>K</b>
70 mm	<b>0,50 W/m<sup>2</sup>K</b>	<b>0,50 W/m<sup>2</sup>K</b>	<b>0,51 W/m<sup>2</sup>K</b>	<b>0,58 W/m<sup>2</sup>K</b>	<b>0,59 W/m<sup>2</sup>K</b>	<b>0,59 W/m<sup>2</sup>K</b>

<b>Glas Verre Glass</b>	<b>76.140</b> Pfosten 60/180 Montant 60/180 Mullion 60/180	<b>76.141</b> Pfosten 60/220 Montant 60/220 Mullion 60/220	<b>76.142</b> Pfosten 60/280 Montant 60/280 Mullion 60/280	<b>76.140</b> Riegel 60/180 Traverse 60/180 Transom 60/180	<b>76.141</b> Riegel 60/220 Traverse 60/220 Transom 60/220	<b>76.142</b> Riegel 60/280 Traverse 60/280 Transom 60/280
50 mm	<b>0,63 W/m<sup>2</sup>K</b>	<b>0,64 W/m<sup>2</sup>K</b>	<b>0,64 W/m<sup>2</sup>K</b>	<b>0,72 W/m<sup>2</sup>K</b>	<b>0,72 W/m<sup>2</sup>K</b>	<b>0,72 W/m<sup>2</sup>K</b>
70 mm	<b>0,51 W/m<sup>2</sup>K</b>	<b>0,51 W/m<sup>2</sup>K</b>	<b>0,51 W/m<sup>2</sup>K</b>	<b>0,59 W/m<sup>2</sup>K</b>	<b>0,59 W/m<sup>2</sup>K</b>	<b>0,59 W/m<sup>2</sup>K</b>

Der Einfluss der Schrauben-  
befestigung in Höhe von 0.14 W/m<sup>2</sup>K  
ist berücksichtigt.

L'influence de la fixation à vis de  
0.14 W/m<sup>2</sup>K est prise en compte.

The 0.14 W/m<sup>2</sup>K influence of the  
screw fixing is taken into account.

**System-Hinweise**

Remarques concernant les systèmes

System instructions

VISS Fassade

VISS façade

VISS façade

**VISS HI 50 mm  
mit Dämmprofil  
Flaches Deckprofil**

**U<sub>f</sub>-Werte nach EN 10077-2**

**VISS HI 50 mm  
avec gaine isolante  
Profilé de recouvrement plat**

**Valeurs U<sub>f</sub> selon EN 10077-2**

**VISS HI 50 mm  
with insulating core  
Flat cover cap**

**U<sub>f</sub> values according to 10077-2**

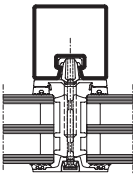
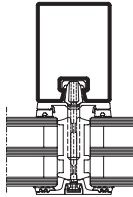
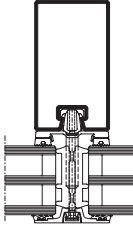
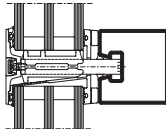
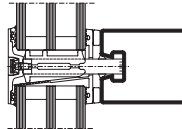
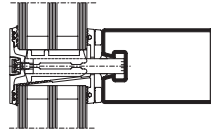
						
<b>Glas Verre Glass</b>	Pfosten 50/50 Montant 50/50 Mullion 50/50	Pfosten 50/95 Montant 50/95 Mullion 50/95	Pfosten 50/140 Montant 50/140 Mullion 50/140	Riegel 50/50 Traverse 50/50 Transom 50/50	Riegel 50/95 Traverse 50/95 Transom 50/95	Riegel 50/140 Traverse 50/140 Transom 50/140
30 mm						
40 mm	<b>0,84 W/m<sup>2</sup>K</b>	<b>0,87 W/m<sup>2</sup>K</b>	<b>0,86 W/m<sup>2</sup>K</b>	<b>0,92 W/m<sup>2</sup>K</b>	<b>0,94 W/m<sup>2</sup>K</b>	<b>0,94 W/m<sup>2</sup>K</b>
50 mm	<b>0,69 W/m<sup>2</sup>K</b>	<b>0,70 W/m<sup>2</sup>K</b>	<b>0,71 W/m<sup>2</sup>K</b>	<b>0,79 W/m<sup>2</sup>K</b>	<b>0,80 W/m<sup>2</sup>K</b>	<b>0,80 W/m<sup>2</sup>K</b>
60 mm	<b>0,62 W/m<sup>2</sup>K</b>	<b>0,63 W/m<sup>2</sup>K</b>	<b>0,63 W/m<sup>2</sup>K</b>	<b>0,69 W/m<sup>2</sup>K</b>	<b>0,70 W/m<sup>2</sup>K</b>	<b>0,70 W/m<sup>2</sup>K</b>
70 mm	<b>0,55 W/m<sup>2</sup>K</b>	<b>0,56 W/m<sup>2</sup>K</b>	<b>0,56 W/m<sup>2</sup>K</b>	<b>0,63 W/m<sup>2</sup>K</b>	<b>0,63 W/m<sup>2</sup>K</b>	<b>0,63 W/m<sup>2</sup>K</b>

Der Einfluss der Schrauben-  
befestigung in Höhe von 0.14 W/m<sup>2</sup>K  
ist berücksichtigt.

L'influence de la fixation à vis de  
0.14 W/m<sup>2</sup>K est prise en compte.

The 0.14 W/m<sup>2</sup>K influence of the  
screw fixing is taken into account.

VISS HI 60 mm  
 mit Dämmprofil  
 Flaches Deckprofil  
 U<sub>f</sub>-Werte nach EN 10077-2

VISS HI 60 mm  
 avec gaine isolante  
 Profilé de recouvrement plat  
 Valeurs U<sub>f</sub> selon EN 10077-2

VISS HI 60 mm  
 with insulating core  
 Flat cover cap  
 U<sub>f</sub> values according to 10077-2

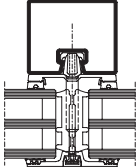
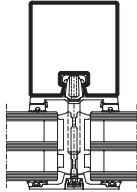
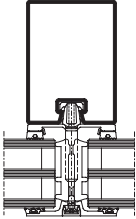
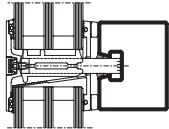
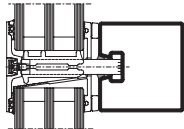
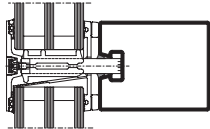
						
<b>Glas</b> <b>Verre</b> <b>Glass</b>	Pfofen 60/50 Montant 60/50 Mullion 60/50	Pfofen 60/100 Montant 60/100 Mullion 60/100	Pfofen 60/150 Montant 60/150 Mullion 60/150	Riegel 60/50 Traverse 60/50 Transom 60/50	Riegel 60/100 Traverse 60/100 Transom 60/100	Riegel 60/150 Traverse 60/150 Transom 60/150
30 mm						
40 mm	<b>0,81 W/m<sup>2</sup>K</b>	<b>0,82 W/m<sup>2</sup>K</b>	<b>0,83 W/m<sup>2</sup>K</b>	<b>0,88 W/m<sup>2</sup>K</b>	<b>0,90 W/m<sup>2</sup>K</b>	<b>0,90 W/m<sup>2</sup>K</b>
50 mm	<b>0,67 W/m<sup>2</sup>K</b>	<b>0,68 W/m<sup>2</sup>K</b>	<b>0,69 W/m<sup>2</sup>K</b>	<b>0,76 W/m<sup>2</sup>K</b>	<b>0,77 W/m<sup>2</sup>K</b>	<b>0,78 W/m<sup>2</sup>K</b>
60 mm	<b>0,59 W/m<sup>2</sup>K</b>	<b>0,60 W/m<sup>2</sup>K</b>	<b>0,60 W/m<sup>2</sup>K</b>	<b>0,67 W/m<sup>2</sup>K</b>	<b>0,68 W/m<sup>2</sup>K</b>	<b>0,69 W/m<sup>2</sup>K</b>
70 mm	<b>0,52 W/m<sup>2</sup>K</b>	<b>0,53 W/m<sup>2</sup>K</b>	<b>0,53 W/m<sup>2</sup>K</b>	<b>0,61 W/m<sup>2</sup>K</b>	<b>0,61 W/m<sup>2</sup>K</b>	<b>0,62 W/m<sup>2</sup>K</b>

<b>Glas</b> <b>Verre</b> <b>Glass</b>	<b>76.140</b> Pfofen 60/180 Montant 60/180 Mullion 60/180	<b>76.141</b> Pfofen 60/220 Montant 60/220 Mullion 60/220	<b>76.142</b> Pfofen 60/280 Montant 60/280 Mullion 60/280	<b>76.140</b> Riegel 60/180 Traverse 60/180 Transom 60/180	<b>76.141</b> Riegel 60/220 Traverse 60/220 Transom 60/220	<b>76.142</b> Riegel 60/280 Traverse 60/280 Transom 60/280
50 mm	<b>0,69 W/m<sup>2</sup>K</b>	<b>0,69 W/m<sup>2</sup>K</b>	<b>0,69 W/m<sup>2</sup>K</b>	<b>0,78 W/m<sup>2</sup>K</b>	<b>0,78 W/m<sup>2</sup>K</b>	<b>0,78 W/m<sup>2</sup>K</b>
70 mm	<b>0,53 W/m<sup>2</sup>K</b>	<b>0,53 W/m<sup>2</sup>K</b>	<b>0,53 W/m<sup>2</sup>K</b>	<b>0,62 W/m<sup>2</sup>K</b>	<b>0,62 W/m<sup>2</sup>K</b>	<b>0,62 W/m<sup>2</sup>K</b>

Der Einfluss der Schrauben-  
 befestigung in Höhe von 0.14 W/m<sup>2</sup>K  
 ist berücksichtigt.

L'influence de la fixation à vis de  
 0.14 W/m<sup>2</sup>K est prise en compte.

The 0.14 W/m<sup>2</sup>K influence of the  
 screw fixing is taken into account.

**System-Hinweise**

**Remarques concernant les systèmes**

**System instructions**

VISS Fassade

VISS façade

VISS façade

**VISS 50 mm**

**U<sub>f</sub>-Werte nach EN 10077-2**

**VISS 50 mm**

**Valeurs U<sub>f</sub> selon EN 10077-2**

**VISS 50 mm**

**U<sub>f</sub> values according to 10077-2**

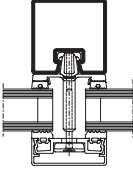
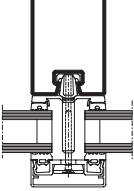
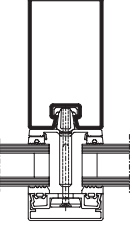
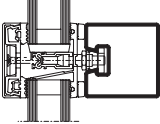
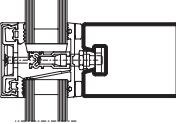
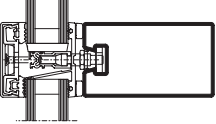
						
<b>Glas Verre Glass</b>	Pfosten 50/50 Montant 50/50 Mullion 50/50	Pfosten 50/95 Montant 50/95 Mullion 50/95	Pfosten 50/140 Montant 50/140 Mullion 50/140	Riegel 50/50 Traverse 50/50 Transom 50/50	Riegel 50/95 Traverse 50/95 Transom 50/95	Riegel 50/140 Traverse 50/140 Transom 50/140
20 mm	1,7 W/m <sup>2</sup> K	1,8 W/m <sup>2</sup> K	1,7 W/m <sup>2</sup> K	1,5 W/m <sup>2</sup> K	1,5 W/m <sup>2</sup> K	1,5 W/m <sup>2</sup> K
30 mm	1,5 W/m <sup>2</sup> K	1,6 W/m <sup>2</sup> K	1,6 W/m <sup>2</sup> K	1,3 W/m <sup>2</sup> K	1,4 W/m <sup>2</sup> K	1,4 W/m <sup>2</sup> K
40 mm	1,4 W/m <sup>2</sup> K	1,5 W/m <sup>2</sup> K	1,5 W/m <sup>2</sup> K	1,3 W/m <sup>2</sup> K	1,3 W/m <sup>2</sup> K	1,3 W/m <sup>2</sup> K
50 mm	1,4 W/m <sup>2</sup> K	1,4 W/m <sup>2</sup> K	1,4 W/m <sup>2</sup> K	1,2 W/m <sup>2</sup> K	1,2 W/m <sup>2</sup> K	1,2 W/m <sup>2</sup> K
60 mm	1,3 W/m <sup>2</sup> K	1,4 W/m <sup>2</sup> K	1,4 W/m <sup>2</sup> K	1,2 W/m <sup>2</sup> K	1,2 W/m <sup>2</sup> K	1,2 W/m <sup>2</sup> K
70 mm	1,3 W/m <sup>2</sup> K	1,3 W/m <sup>2</sup> K	1,3 W/m <sup>2</sup> K	1,2 W/m <sup>2</sup> K	1,2 W/m <sup>2</sup> K	1,2 W/m <sup>2</sup> K

**Der Einfluss der Schraubenbefestigung in Höhe von 0.14 W/m<sup>2</sup>K ist berücksichtigt.**

**L'influence de la fixation à vis de 0.14 W/m<sup>2</sup>K est prise en compte.**

**The 0.14 W/m<sup>2</sup>K influence of the screw fixing is taken into account.**



**System-Hinweise**

Remarques concernant les systèmes

System instructions

VISS Fassade

VISS façade

VISS façade

**VISS 60 mm**

$U_f$ -Werte nach EN 10077-2

**VISS 60 mm**

Valeurs  $U_f$  selon EN 10077-2

**VISS 60 mm**

$U_f$  values according to 10077-2

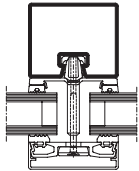
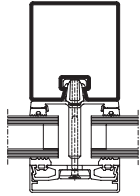
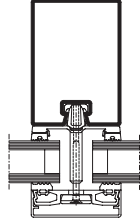
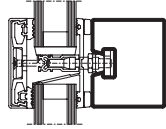
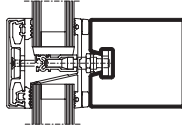
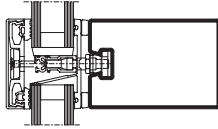
						
<b>Glas</b> <b>Verre</b> <b>Glass</b>	Pfosten 60/50 Montant 60/50 Mullion 60/50	Pfosten 60/100 Montant 60/100 Mullion 60/100	Pfosten 60/150 Montant 60/150 Mullion 60/150	Riegel 60/50 Traverse 60/50 Transom 60/50	Riegel 60/100 Traverse 60/100 Transom 60/100	Riegel 60/150 Traverse 60/150 Transom 60/150
20 mm	1,6 W/m <sup>2</sup> K	1,7 W/m <sup>2</sup> K	1,6 W/m <sup>2</sup> K	1,4 W/m <sup>2</sup> K	1,4 W/m <sup>2</sup> K	1,5 W/m <sup>2</sup> K
30 mm	1,4 W/m <sup>2</sup> K	1,5 W/m <sup>2</sup> K	1,4 W/m <sup>2</sup> K	1,2 W/m <sup>2</sup> K	1,3 W/m <sup>2</sup> K	1,3 W/m <sup>2</sup> K
40 mm	1,3 W/m <sup>2</sup> K	1,3 W/m <sup>2</sup> K	1,3 W/m <sup>2</sup> K	1,1 W/m <sup>2</sup> K	1,2 W/m <sup>2</sup> K	1,2 W/m <sup>2</sup> K
50 mm	1,2 W/m <sup>2</sup> K	1,2 W/m <sup>2</sup> K	1,2 W/m <sup>2</sup> K	1,1 W/m <sup>2</sup> K	1,1 W/m <sup>2</sup> K	1,1 W/m <sup>2</sup> K
60 mm	1,1 W/m <sup>2</sup> K	1,2 W/m <sup>2</sup> K	1,1 W/m <sup>2</sup> K	1,0 W/m <sup>2</sup> K	1,1 W/m <sup>2</sup> K	1,1 W/m <sup>2</sup> K
70 mm	1,1 W/m <sup>2</sup> K	1,1 W/m <sup>2</sup> K	1,1 W/m <sup>2</sup> K	1,0 W/m <sup>2</sup> K	1,0 W/m <sup>2</sup> K	1,0 W/m <sup>2</sup> K

<b>Glas</b> <b>Verre</b> <b>Glass</b>	<b>76.140</b> Pfosten 60/180 Montant 60/180 Mullion 60/180	<b>76.141</b> Pfosten 60/220 Montant 60/220 Mullion 60/220	<b>76.142</b> Pfosten 60/280 Montant 60/280 Mullion 60/280	<b>76.140</b> Riegel 60/180 Traverse 60/180 Transom 60/180	<b>76.141</b> Riegel 60/220 Traverse 60/220 Transom 60/220	<b>76.142</b> Riegel 60/280 Traverse 60/280 Transom 60/280
50 mm	1,3 W/m <sup>2</sup> K	1,3 W/m <sup>2</sup> K	1,3 W/m <sup>2</sup> K	1,1 W/m <sup>2</sup> K	1,1 W/m <sup>2</sup> K	1,1 W/m <sup>2</sup> K
70 mm	1,1 W/m <sup>2</sup> K	1,1 W/m <sup>2</sup> K	1,1 W/m <sup>2</sup> K	1,0 W/m <sup>2</sup> K	1,0 W/m <sup>2</sup> K	1,0 W/m <sup>2</sup> K

Der Einfluss der Schraubenbefestigung in Höhe von 0.14 W/m<sup>2</sup>K ist berücksichtigt.

L'influence de la fixation à vis de 0.14 W/m<sup>2</sup>K est prise en compte.

The 0.14 W/m<sup>2</sup>K influence of the screw fixing is taken into account.

**System-Hinweise**

**Remarques concernant les systèmes**

**System instructions**

VISS Fassade

VISS façade

VISS façade

**VISS 50 mm  
Flaches Deckprofil**

**U<sub>f</sub>-Werte nach EN 10077-2**

**VISS 50 mm  
Profilé de recouvrement plat**

**Valeurs U<sub>f</sub> selon EN 10077-2**

**VISS 50 mm  
Flat cover cap**

**U<sub>f</sub> values according to 10077-2**

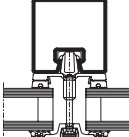
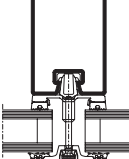
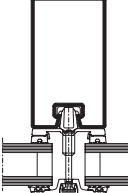
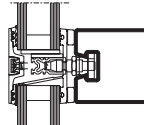
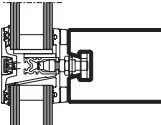
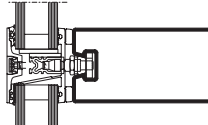
						
<b>Glas Verre Glass</b>	Pfosten 50/50 Montant 50/50 Mullion 50/50	Pfosten 50/95 Montant 50/95 Mullion 50/95	Pfosten 50/140 Montant 50/140 Mullion 50/140	Riegel 50/50 Traverse 50/50 Transom 50/50	Riegel 50/95 Traverse 50/95 Transom 50/95	Riegel 50/140 Traverse 50/140 Transom 50/140
20 mm	1,9 W/m <sup>2</sup> K	2,0 W/m <sup>2</sup> K	2,0 W/m <sup>2</sup> K	1,6 W/m <sup>2</sup> K	1,7 W/m <sup>2</sup> K	1,7 W/m <sup>2</sup> K
30 mm	1,7 W/m <sup>2</sup> K	1,7 W/m <sup>2</sup> K	1,7 W/m <sup>2</sup> K	1,4 W/m <sup>2</sup> K	1,5 W/m <sup>2</sup> K	1,5 W/m <sup>2</sup> K
40 mm	1,5 W/m <sup>2</sup> K	1,6 W/m <sup>2</sup> K	1,6 W/m <sup>2</sup> K	1,3 W/m <sup>2</sup> K	1,4 W/m <sup>2</sup> K	1,4 W/m <sup>2</sup> K
50 mm	1,4 W/m <sup>2</sup> K	1,5 W/m <sup>2</sup> K	1,5 W/m <sup>2</sup> K	1,3 W/m <sup>2</sup> K	1,3 W/m <sup>2</sup> K	1,3 W/m <sup>2</sup> K
60 mm	1,4 W/m <sup>2</sup> K	1,4 W/m <sup>2</sup> K	1,4 W/m <sup>2</sup> K	1,2 W/m <sup>2</sup> K	1,3 W/m <sup>2</sup> K	1,3 W/m <sup>2</sup> K
70 mm	1,3 W/m <sup>2</sup> K	1,3 W/m <sup>2</sup> K	1,3 W/m <sup>2</sup> K	1,2 W/m <sup>2</sup> K	1,2 W/m <sup>2</sup> K	1,2 W/m <sup>2</sup> K

**Der Einfluss der Schrauben-  
befestigung in Höhe von 0.14 W/m<sup>2</sup>K  
ist berücksichtigt.**

**L'influence de la fixation à vis de  
0.14 W/m<sup>2</sup>K est prise en compte.**

**The 0.14 W/m<sup>2</sup>K influence of the  
screw fixing is taken into account.**

**System-Hinweise**

Remarques concernant les systèmes

System instructions

VISS Fassade

VISS façade

VISS façade

**VISS 60 mm**  
Flaches Deckprofil

U<sub>f</sub>-Werte nach EN 10077-2

**VISS 60 mm**  
Profilé de recouvrement plat

Valeurs U<sub>f</sub> selon EN 10077-2

**VISS 60 mm**  
Flat cover cap

U<sub>f</sub> values according to 10077-2

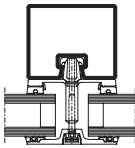
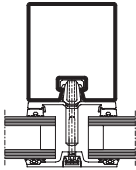
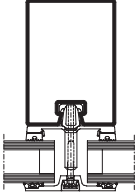
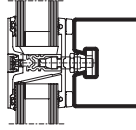
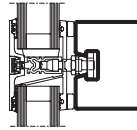
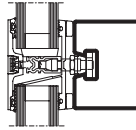
						
<b>Glas</b> <b>Verre</b> <b>Glass</b>	Pfosten 60/50 Montant 60/50 Mullion 60/50	Pfosten 60/100 Montant 60/100 Mullion 60/100	Pfosten 60/150 Montant 60/150 Mullion 60/150	Riegel 60/50 Traverse 60/50 Transom 60/50	Riegel 60/100 Traverse 60/100 Transom 60/100	Riegel 60/150 Traverse 60/150 Transom 60/150
20 mm	1,7 W/m <sup>2</sup> K	1,8 W/m <sup>2</sup> K	1,8 W/m <sup>2</sup> K	1,5 W/m <sup>2</sup> K	1,6 W/m <sup>2</sup> K	1,6 W/m <sup>2</sup> K
30 mm	1,5 W/m <sup>2</sup> K	1,5 W/m <sup>2</sup> K	1,6 W/m <sup>2</sup> K	1,3 W/m <sup>2</sup> K	1,3 W/m <sup>2</sup> K	1,4 W/m <sup>2</sup> K
40 mm	1,3 W/m <sup>2</sup> K	1,4 W/m <sup>2</sup> K	1,4 W/m <sup>2</sup> K	1,2 W/m <sup>2</sup> K	1,2 W/m <sup>2</sup> K	1,2 W/m <sup>2</sup> K
50 mm	1,2 W/m <sup>2</sup> K	1,3 W/m <sup>2</sup> K	1,3 W/m <sup>2</sup> K	1,1 W/m <sup>2</sup> K	1,2 W/m <sup>2</sup> K	1,2 W/m <sup>2</sup> K
60 mm	1,2 W/m <sup>2</sup> K	1,2 W/m <sup>2</sup> K	1,2 W/m <sup>2</sup> K	1,1 W/m <sup>2</sup> K	1,1 W/m <sup>2</sup> K	1,1 W/m <sup>2</sup> K
70 mm	1,1 W/m <sup>2</sup> K	1,1 W/m <sup>2</sup> K	1,2 W/m <sup>2</sup> K	1,1 W/m <sup>2</sup> K	1,1 W/m <sup>2</sup> K	1,1 W/m <sup>2</sup> K

	<b>76.140</b>	<b>76.141</b>	<b>76.142</b>	<b>76.140</b>	<b>76.141</b>	<b>76.142</b>
<b>Glas</b> <b>Verre</b> <b>Glass</b>	Pfosten 60/180 Montant 60/180 Mullion 60/180	Pfosten 60/220 Montant 60/220 Mullion 60/220	Pfosten 60/280 Montant 60/280 Mullion 60/280	Riegel 60/180 Traverse 60/180 Transom 60/180	Riegel 60/220 Traverse 60/220 Transom 60/220	Riegel 60/280 Traverse 60/280 Transom 60/280
50 mm	1,3 W/m <sup>2</sup> K	1,3 W/m <sup>2</sup> K	1,3 W/m <sup>2</sup> K	1,2 W/m <sup>2</sup> K	1,2 W/m <sup>2</sup> K	1,2 W/m <sup>2</sup> K
70 mm	1,2 W/m <sup>2</sup> K	1,2 W/m <sup>2</sup> K	1,2 W/m <sup>2</sup> K	1,1 W/m <sup>2</sup> K	1,1 W/m <sup>2</sup> K	1,1 W/m <sup>2</sup> K

Der Einfluss der Schraubenbefestigung in Höhe von 0.14 W/m<sup>2</sup>K ist berücksichtigt.

L'influence de la fixation à vis de 0.14 W/m<sup>2</sup>K est prise en compte.

The 0.14 W/m<sup>2</sup>K influence of the screw fixing is taken into account.

Jansen AG

**Steel Systems**  
Industriestrasse 34  
9463 Oberriet  
Schweiz  
[jansen.com](http://jansen.com)

**JANSEN**  
Configure to Inspire