

VISS Basic Fassaden

Trägerunabhängige hochwärmegeämmte Vertikalfassaden

VISS Basic façades

Façades verticales à haute rupture de pont thermique indépendantes du porteur

VISS Basic façades

Highly thermally insulated beam independant vertical façades

Inhaltsverzeichnis**Sommaire****Content**

VISS Basic Fassade

VISS Basic façade

VISS Basic façade

SystemübersichtMerkmale
Leistungseigenschaften**Sommaire du système**Caractéristiques
Caractéristiques de performance**Summary of system**Characteristics
Performance characteristics**2**

Profilsortiment

Deckprofile 50 und 60 mm

Assortiment de profilé

Profilés de recouvrement 50 et 60 mm

Range of profiles

Cover sections 50 and 60 mm

6

Konstruktions-HinweiseSchnittpunkte
Konstruktionsdetails
Anschlüsse am Bau**Indications du construction**Coupes de détails
Détails de construction
Raccords au mur**Construction instructions**Section details
Construction details
Attachment to structure**9**

Alle Ausführungen dieser Dokumentation haben wir sorgfältig und nach bestem Wissen zusammengestellt. Wir können aber keine Verantwortung für die Benützung der vermittelten Vorschläge und Daten übernehmen. Wir behalten uns technische Änderungen ohne Vorankündigung vor.
Aktuelle Version auf www.jansen.com

Nous avons apporté le plus grand soin à l'élaboration de cette documentation. Cependant, nous déclinons toute responsabilité pour l'utilisation faite de nos propositions et de nos données.
Nous nous réservons le droit de procéder à des modifications techniques sans préavis.
Version actuelle sur www.jansen.com

All the information contained in this documentation is given to the best of our knowledge and ability. However, we decline all responsibility for the use made of these suggestions and data.
We reserve the right to effect technical modifications without prior warning.
Current version available at www.jansen.com

Merkmale
Caractéristiques
Characteristics

VISS Basic Fassade
VISS Basic façade
VISS Basic façade







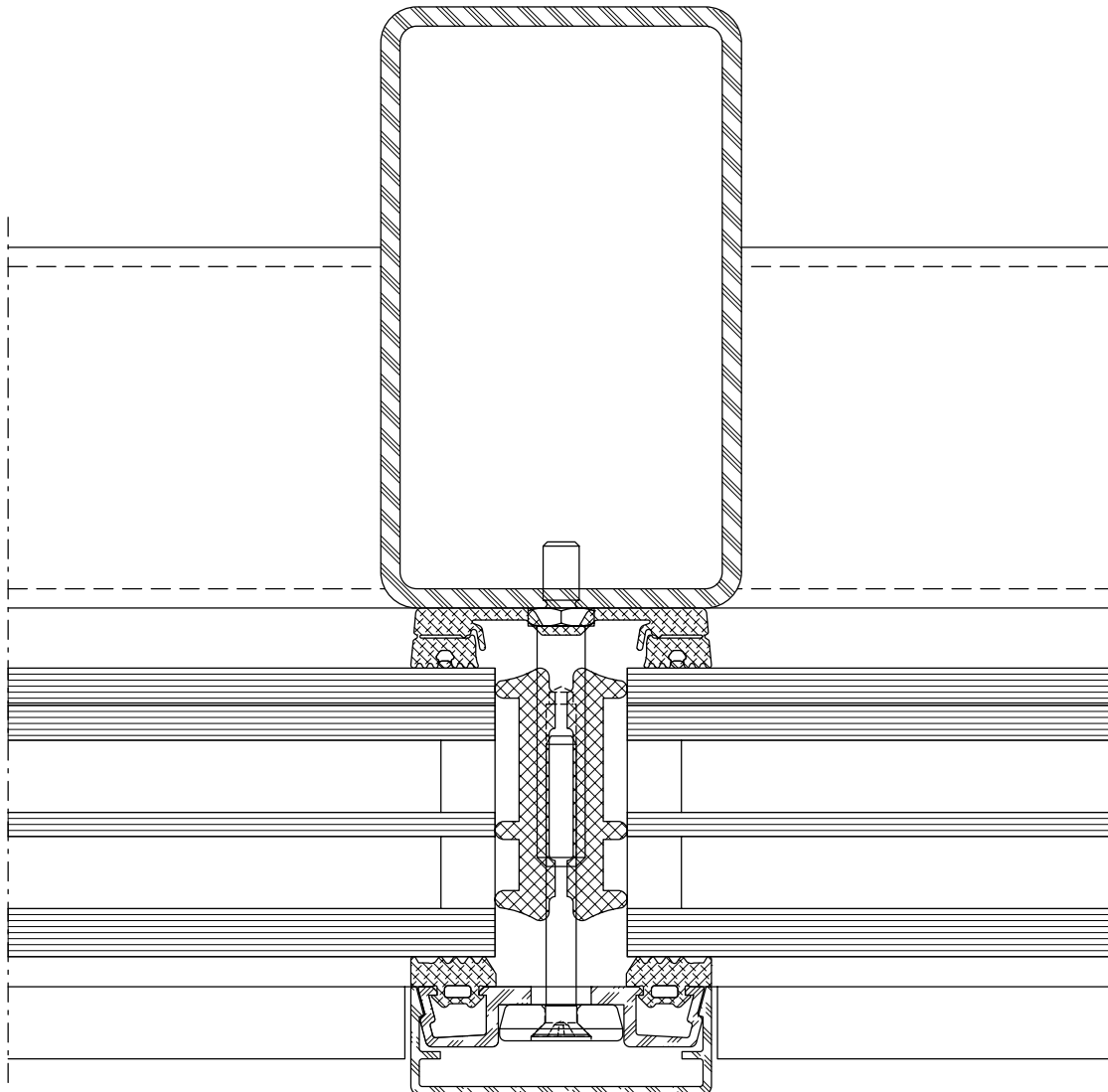

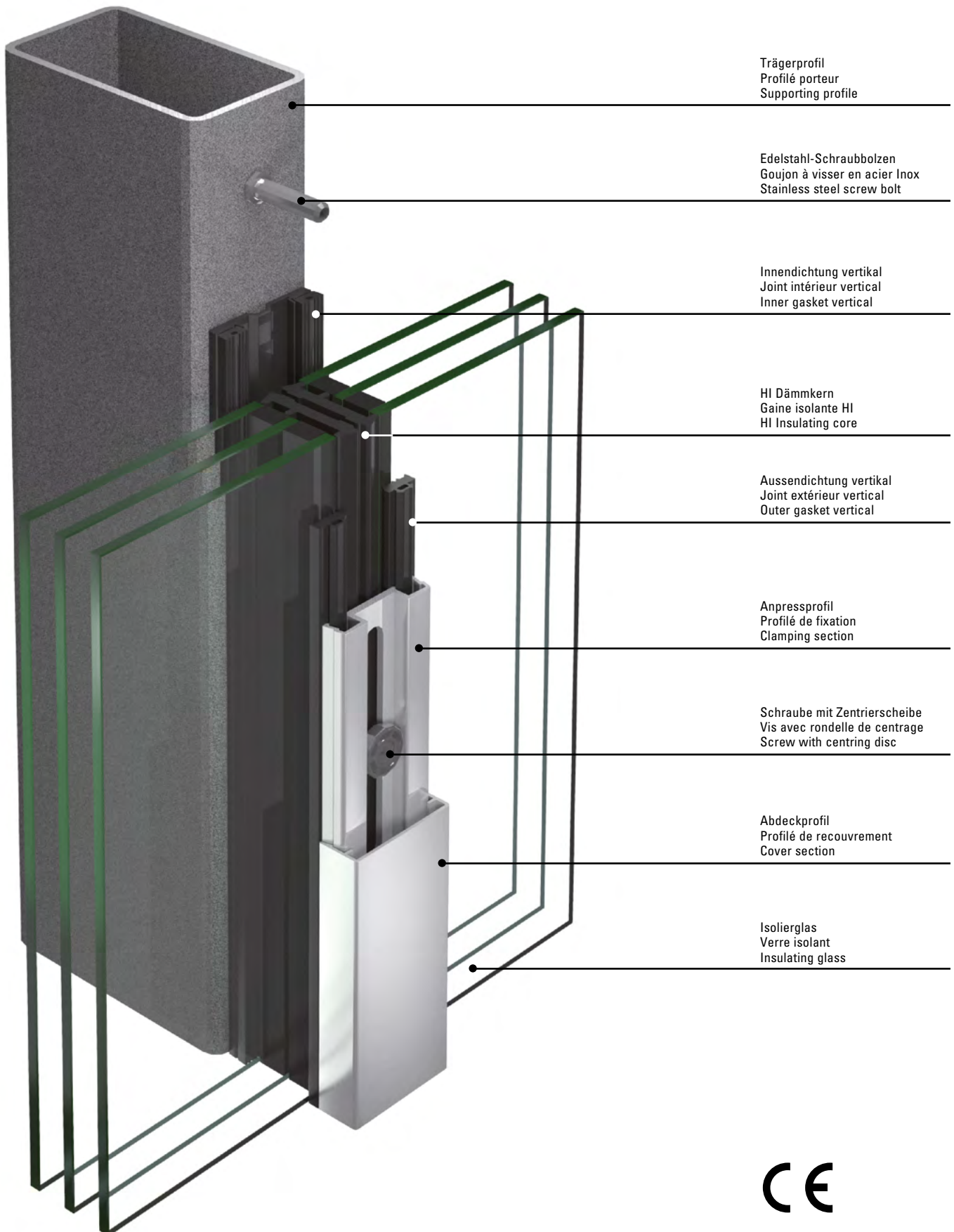
- CE-Kennzeichnung nach EN 13830
- U_f Wert bis 0.51 W/m²K
- Ansichtsbreiten 50 und 60 mm
- Füllelementstärken 6 bis 70 mm
- Füllelementgewichte bis 1800 kg
- Handelsübliche Hohlprofile, IPE-Träger, etc.
- VISS I_xtra massgefertigte, lasergeschweisste, scharfkantige Profile
- Kombinierbar mit dem Standard VISS System, der Brandschutzlösung VISS Fire und der einbruchhemmenden Variante VISS RC

- Marquage CE selon EN 13830
- Valeur U_f jusqu'à 0.51 W/m²K
- Largeurs de face 50 et 60 mm
- Éléments de remplissage de 6 à 70 mm d'épaisseur
- Poids de remplissage jusqu'à 1800 kg
- Profilés creux usuels, Porteurs IPE, etc.
- Profilés VISS I_xtra sur mesure, soudés au laser, à angles vifs
- Combinable avec le système standard VISS, la protection incendie VISS Fire et la variante anti-effraction VISS RC

- CE marking in accordance with EN 13830
- U_f value to 0.51 W/m²K
- 50 and 60 mm face widths
- Infill panel thicknesses of 6 to 70 mm
- Infill unit weights up to 1800 kg
- Standard hollow profiles, IPE beams, etc.
- VISS I_xtra custom-made, laser-welded, square-edge profiles
- Can be combined with the standard VISS system, the VISS Fire fire protection solution and the VISS RC burglar-resistant version





	Prüfungen (Prüfnorm) Essais (Norme d'essai) Tests (Test standard)	Klassifizierungs-Norm Norme de classification Classification standard	Werte Valeurs Values
	Schlagregendichtheit (EN 12155) Etanchéité à la pluie battante (EN 12155) Watertightness (EN 12155)	EN 12154	RE 1200
	Widerstand bei Windlast (EN 12179) Résistance à la pression du vent (EN 12179) Resistance to wind load (EN 12179)	EN 13116	Bemessungslast 2 kN/m ² Charge de calcul 2 kN/m ² Designed load 2 kN/m ²
	Luftdurchlässigkeit (EN 12153) Perméabilité à l'air (EN 12153) Air permeability (EN 12153)	EN 12152	Klasse AE Classe AE Class AE
	Wärmedurchgangskoeffizient (EN 13947) Transmission thermique (EN 13947) Thermal transmittance (EN 13947)	EN ISO 10077-2	ab $U_f > 0.51 \text{ W/m}^2\text{K}$ dès $U_f > 0.51 \text{ W/m}^2\text{K}$ from $U_f > 0.51 \text{ W/m}^2\text{K}$
	Schallschutz (EN ISO 140-3) Isolation phonique (EN ISO 140-3) Sound insulation (EN ISO 140-3)	EN ISO 717-1	npd
	Einbruchhemmung Anti-effraction Burglar resistance	prEN 1627	RC2 / RC3 / RC4
	Stossfestigkeit Résistance au chocs Impact strength	EN 14019	Klasse E5 / I5 Classe E5 / I5 Class E5 / I5
	Brandverhalten Réaction au feu Reaction to fire	EN 13501-1	Klasse E Classe E Class E
	Technische Regeln für die Verwendung von absturzsichernden Verglasungen Règlement technique pour la sécurité anti-chute des vitrages The technical regulations for protecting glazing against falling out	DIN 18008	Kategorie A Catégorie A Category A

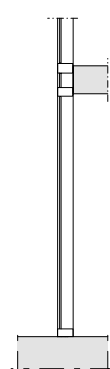
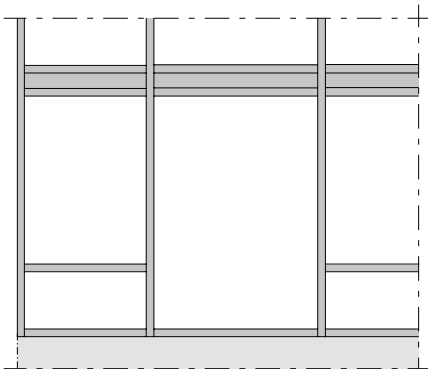
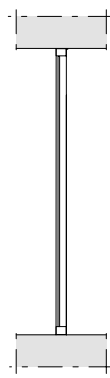
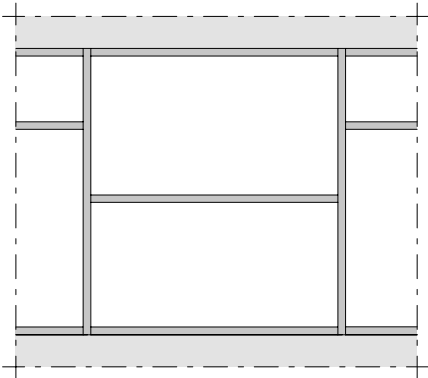
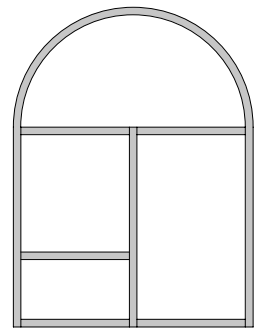
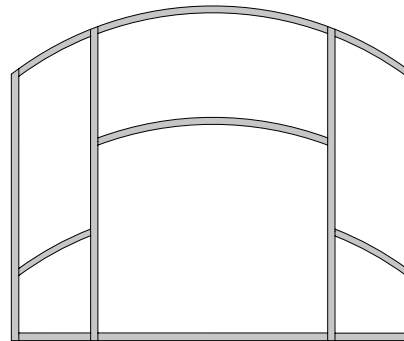
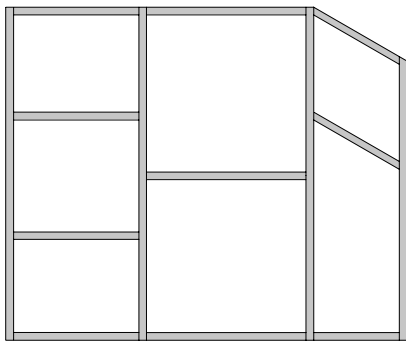
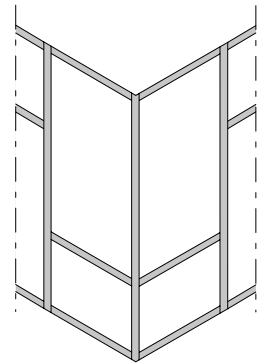
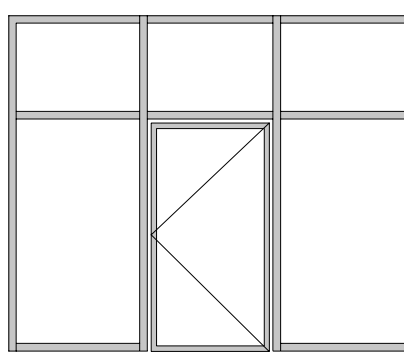
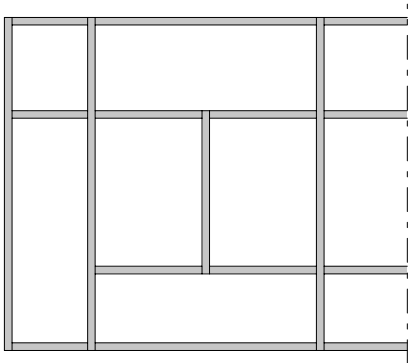

Jansen Docu Center

Die Plattform zum effizienten Arbeiten mit Jansen Dokumentationen. Im Jansen Docu Center stehen alle Produktinformationen jederzeit digital in der aktuellsten Version zur Verfügung: von Architekten-Informationen über Bestell- und Fertigungskatalogen bis hin zu Anleitungen und Prospekten sowie Videos.

Die Inhalte können einfach und schnell aufgerufen werden. Ein für den Anwender komfortables papierloses Arbeiten, das zahlreiche Vorteile bietet.

Download CAD Daten

DXF

DWG

Sie können die Zeichnungen in den Formaten DXF und/oder DWG herunterladen. Klicken Sie auf das entsprechende Icon und der Download erfolgt.

Die Hinweise «Artikelbibliothek/Türbeschläge/Fensterbeschläge» bedeuten, dass Sie mit einem Klick die gesamte Artikelbibliothek des entsprechenden Systems herunterladen (Profile, Beschläge, Glasleisten, Zubehör etc.).

Info und Beratung

Gerne beraten wir Sie persönlich und stehen Ihnen bei Fragen zur Verfügung. Bitte schreiben Sie uns Ihre Anliegen an: info@jansen.com

Jansen Docu Center

La plate-forme pour travailler efficacement avec les documentations Jansen. Le Jansen Docu Center met à votre disposition les informations sur les produits, en format numérique et dans une version actualisée: des catalogues de commande et de fabrication aux instructions et prospectus, en passant par les informations destinées aux architectes et vidéos.

Les contenus sont facilement et rapidement accessibles. Une manière de travailler confortable et offrant de nombreux avantages.

Télécharger fichiers DAO

DXF

DWG

Vous pouvez télécharger les dessins aux formats DXF et/ou DWG. Cliquez sur l'icône correspondante et le téléchargement s'effectuera.

Les indications «Bibliothèque des articles/Ferures de porte/Ferrures de fenêtres» signifie que vous téléchargez la totalité de la bibliothèque des articles du système donné (profilés, ferrures, parcloles, accessoires etc.).

Info et conseils

Nous vous conseillons volontiers individuellement et sommes à votre disposition si vous avez des questions à poser. Veuillez nous envoyer votre requête à: info@jansen.com

Jansen Docu Center

The platform for working efficiently with Jansen documentation. The latest version of all the product information is available digitally at any time in the Jansen Docu Center – from order and fabrication manuals to architect information, instructions and brochures and videos.

The content can be retrieved quickly and easily. The user can work conveniently without paper, which has numerous benefits.

Download CAD files

DXF

DWG

You can download the drawings in DXF and/or DWG format. Click on the relevant icon to begin the download.

The items «Article library/Door fittings/Window fittings» means that you download the entire article library for the corresponding system with one click (profiles, fittings, glazing beads, accessories etc.).

Information and advice

We would be delighted to provide you with advice in person and are available to answer any questions you may have. Please write to us with your queries at: info@jansen.com

Deckprofile 50 mm (Masstab 1:3)
 Profils de recouvrement 50 mm (échelle 1:3)
 Cover sections 50 mm (scale 1:3)

VISS Basic Fassade
 VISS Basic façade
 VISS Basic façade

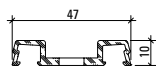

407.800

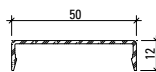

407.860

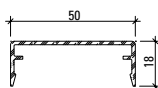

407.861

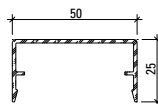

407.862

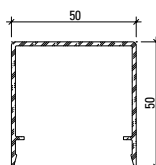

407.863

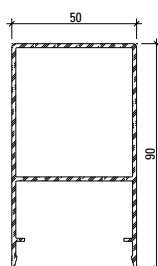

407.864

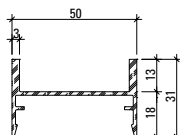

407.900

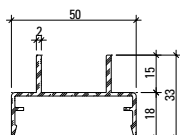

407.911

Werkstoff

Aluminium EN AW 6060 T66 roh, leicht eingeölt

Matériau

Aluminium EN AW 6060 T66 brut, légèrement huilé

Material

Aluminium EN AW 6060 T66 mill finish, slightly oiled

Profil-Nr.	G kg/m	U m ² /m	P m ² /m	L mm
407.800	0,414			6000
407.860	0,266	0,147	0,072	6000
407.861	0,341	0,185	0,084	6000
407.862	0,394	0,213	0,098	6000

Profil-Nr.	G kg/m	U m ² /m	P m ² /m	L mm
407.863	0,660	0,313	0,148	6000
407.864	1,344	0,360	0,228	6000
407.900	0,556	0,240	0,138	6000
407.911	0,510	0,245	0,146	6000

Deckprofile 50 mm (Masstab 1:3)**Profils de recouvrement 50 mm (échelle 1:3)****Cover sections 50 mm (scale 1:3)**

VISS Basic Fassade

VISS Basic façade

VISS Basic façade

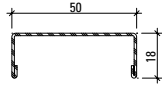
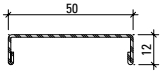
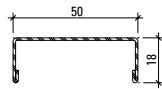
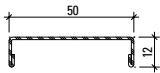
**Edelstahl Deckprofile
Sparren****Profils de recouvrement acier Inox
Chevron****Stainless steel cover sections
Rafters**Werkstoff 1.4301 (AISI 304)
geschliffen, Korn 220/240,
mit SchutzfolieQualité 1.4301 (AISI 304)
meulé, degré 220/240,
avec feuille de protectionMaterial 1.4301 (AISI 304)
polished, grain 220/240,
with protective film**400.860****400.861**Werkstoff 1.4401 (AISI 316)
geschliffen, Korn 220/240,
mit SchutzfolieQualité 1.4401 (AISI 316)
meulé, degré 220/240,
avec feuille de protectionMaterial 1.4401 (AISI 316)
polished, grain 220/240,
with protective film**400.862****400.863**

Profil-Nr.	G kg/m	L mm
400.860	0,644	6000
400.861	0,734	6000

Profil-Nr.	G kg/m	L mm
400.862	0,652	6000
400.863	0,744	6000

Artikelbibliothek
Bibliothèque des articles
Article library

DXF

DWG

Deckprofile 60 mm (Massstab 1:3)
Profils de recouvrement 60 mm (échelle 1:3)
Cover sections 60 mm (scale 1:3)

VISS Basic Fassade
 VISS Basic façade
 VISS Basic façade

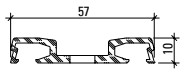

407.802

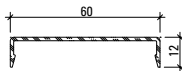

407.865

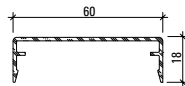

407.866

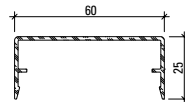

407.867

Werkstoff

Aluminium EN AW 6060 T66 roh,
 leicht eingeölt

Matériau

Aluminium EN AW 6060 T66 brut,
 légèrement huilé

Material

Aluminium EN AW 6060 T66 mill finish,
 slightly oiled

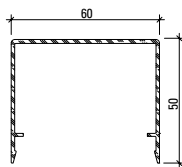

407.868

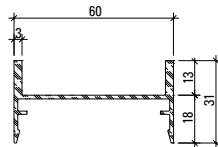

407.901

Profil-Nr.	G kg/m	U m ² /m	P m ² /m	L mm
407.802	0,558	0,190		6000
407.865	0,304	0,167	0,082	6000
407.866	0,379	0,205	0,094	6000
407.867	0,432	0,223	0,108	6000

Profil-Nr.	G kg/m	U m ² /m	P m ² /m	L mm
407.868	0,750	0,330	0,160	6000
407.901	0,590	0,255	0,148	6000

Artikelbibliothek
 Bibliothèque des articles
 Article library

DXF **DWG**

Schnittpunkte im Massstab 1:1
Coupe de détails à l'échelle 1:1
Section details on scale 1:1

VISS Basic Fassade
VISS Basic façade
VISS Basic façade

VISS Basic HI

Pfosten-Detail
Ansichtsbreite 50 mm
Schraubbolzen

VISS Basic HI

Détail du montant
Largeur de face 50 mm
Goujon à visser

VISS Basic HI

Detail of mullion
Width 50 mm
Screw bolt

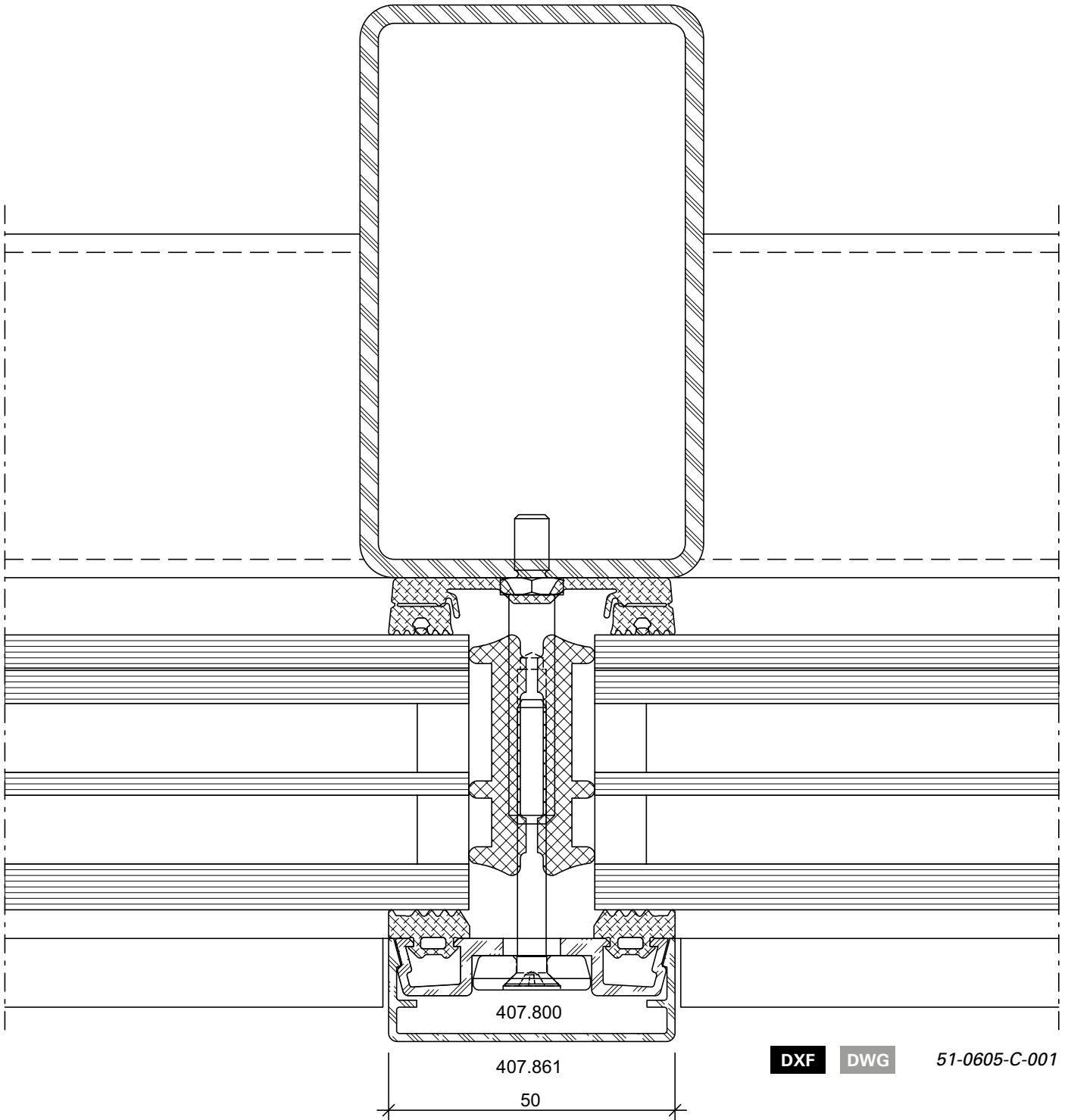

DXF

DWG

51-0605-C-001

Schnittpunkte im Massstab 1:1
Coupe de détails à l'échelle 1:1
Section details on scale 1:1

VISS Basic Fassade
VISS Basic façade
VISS Basic façade

VISS Basic HI
Riegel-Detail
Ansichtsbreite 50 mm
Schraubbolzen

VISS Basic HI
Détail de la traverse
Largeur de face 50 mm
Goujon à visser

VISS Basic HI
Detail of transom
Width 50 mm
Screw bolt

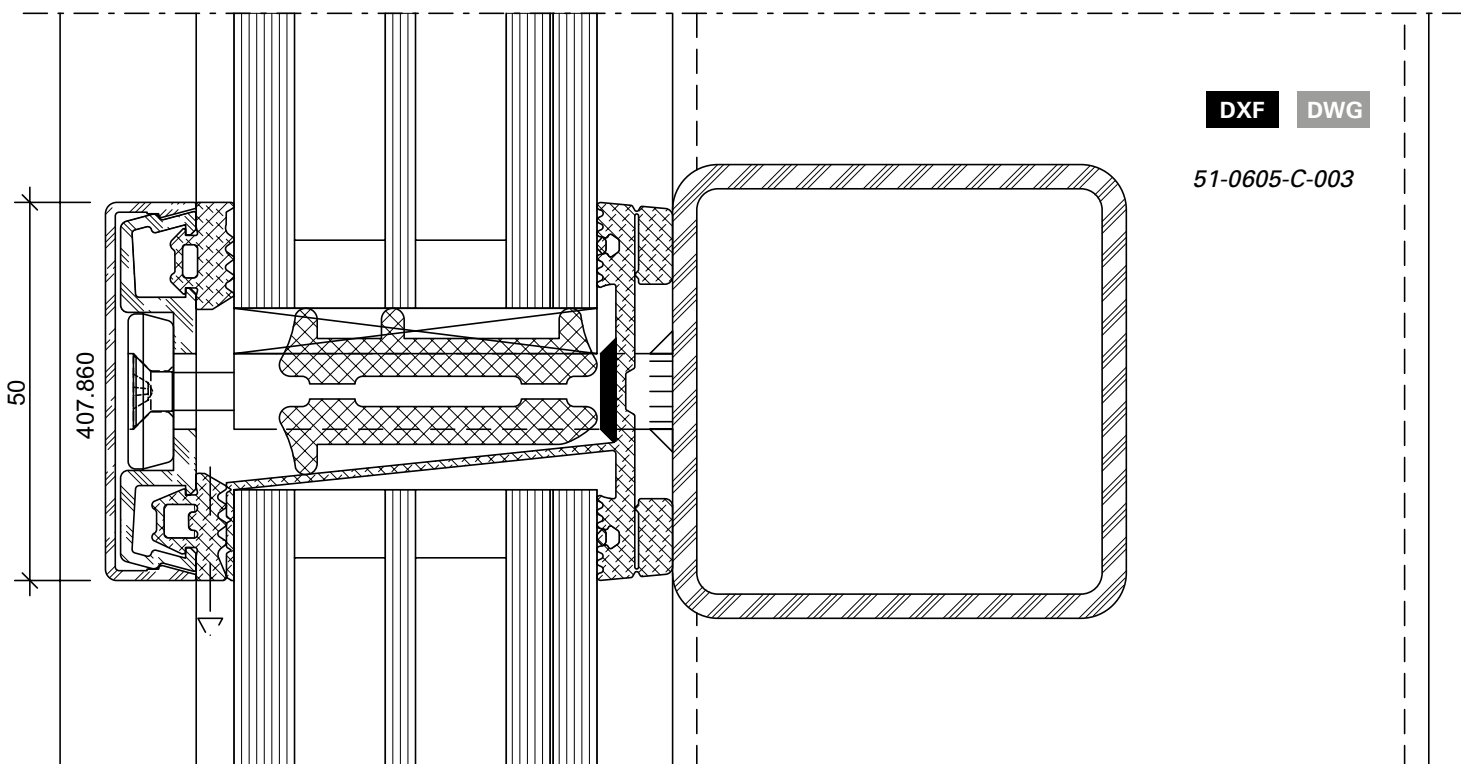
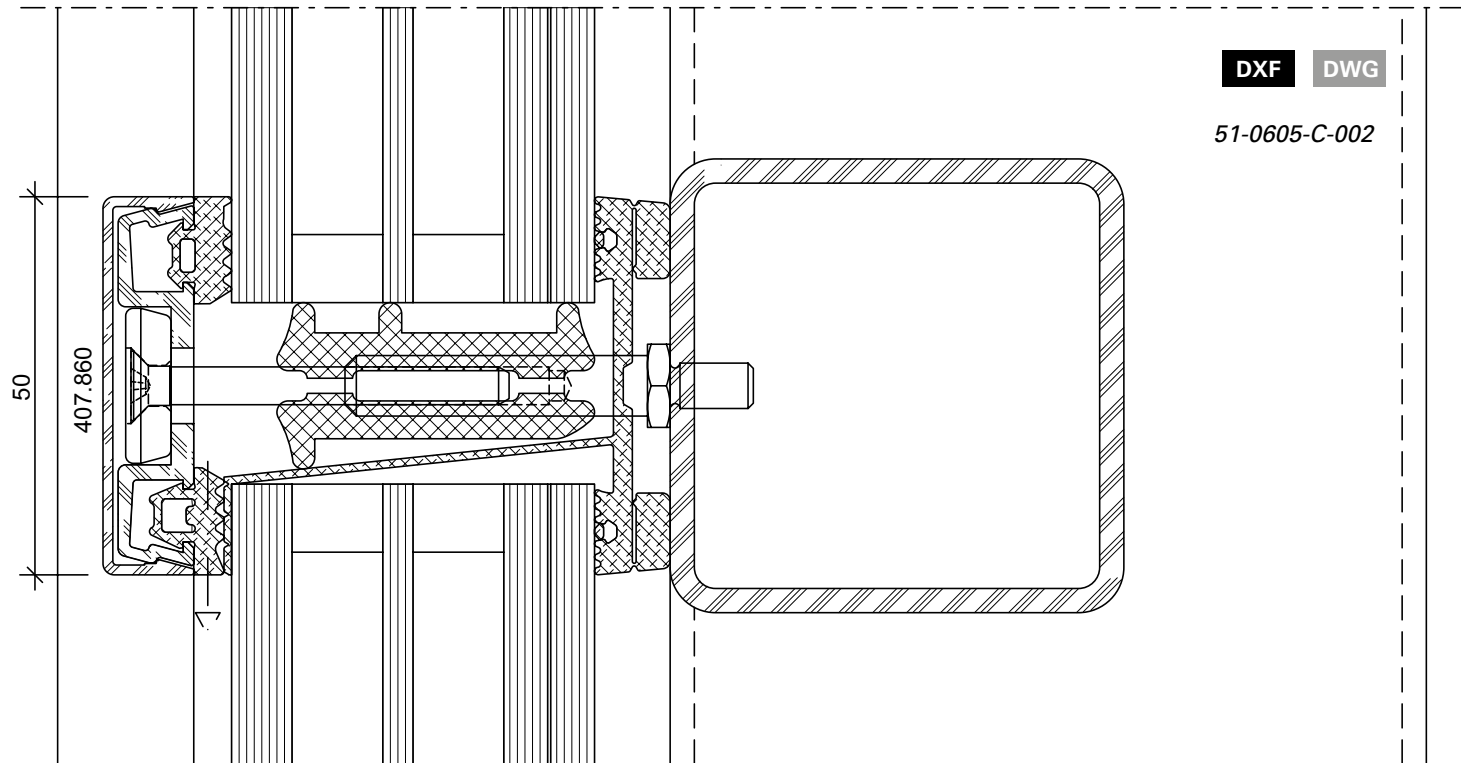

Schnittpunkte im Massstab 1:1
Coupe de détails à l'échelle 1:1
Section details on scale 1:1

VISS Basic Fassade
VISS Basic façade
VISS Basic façade

Pfosten-Detail
Ansichtsbreite 50 mm
Schraubbolzen

Détail du montant
Largeur de face 50 mm
Goujon à visser

Detail of mullion
Width 50 mm
Screw bolt

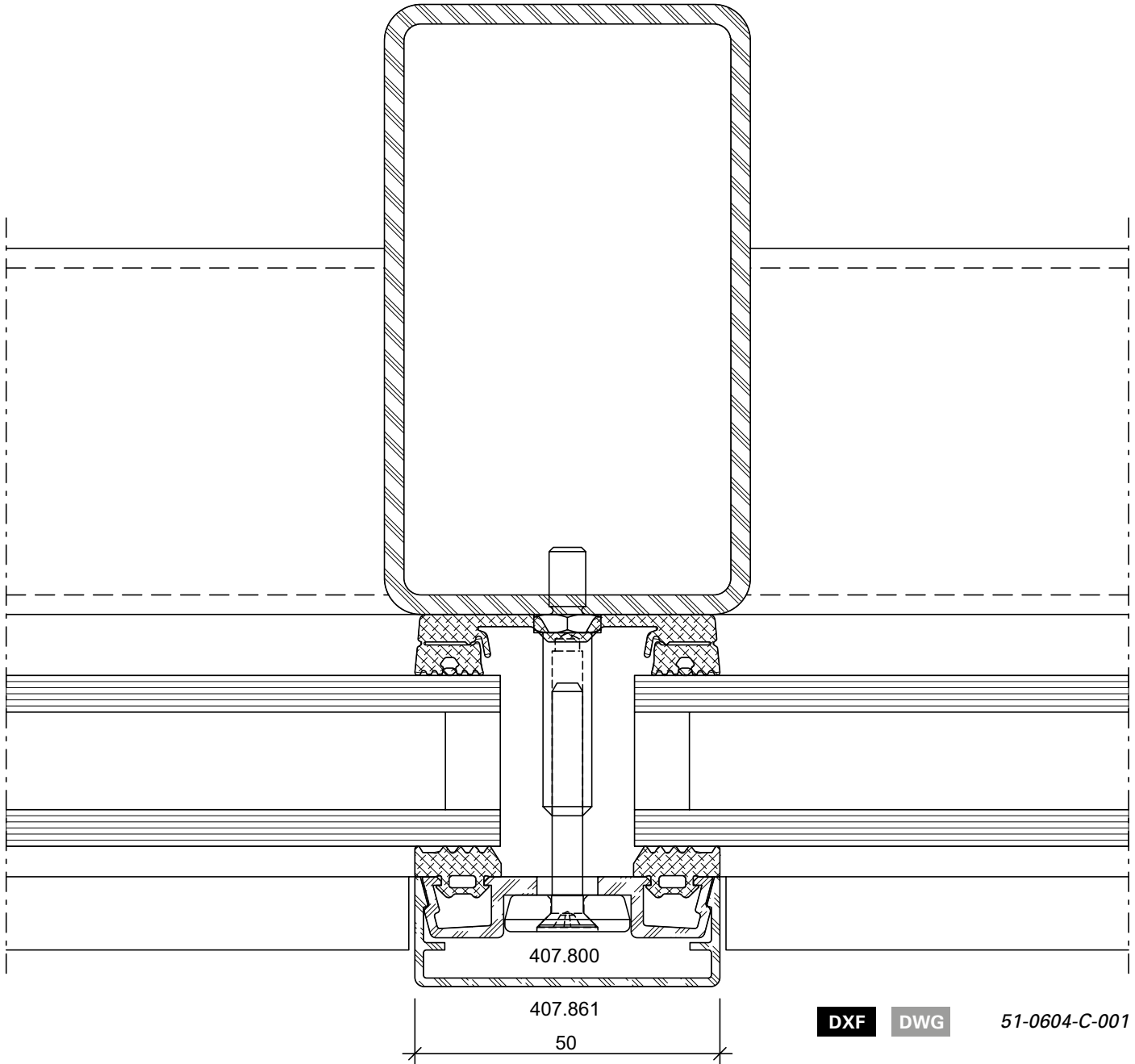

DXF DWG

51-0604-C-001

Schnittpunkte im Massstab 1:1
Coupe de détails à l'échelle 1:1
Section details on scale 1:1

VISS Basic Fassade
VISS Basic façade
VISS Basic façade

Pfosten-Detail VISS I_x tra
Ansichtsbreite 50 mm
Schraubbolzen

Détail du montant VISS I_x tra
Largeur de face 50 mm
Goujon à visser

Detail of mullion VISS I_x tra
Width 50 mm
Screw bolt

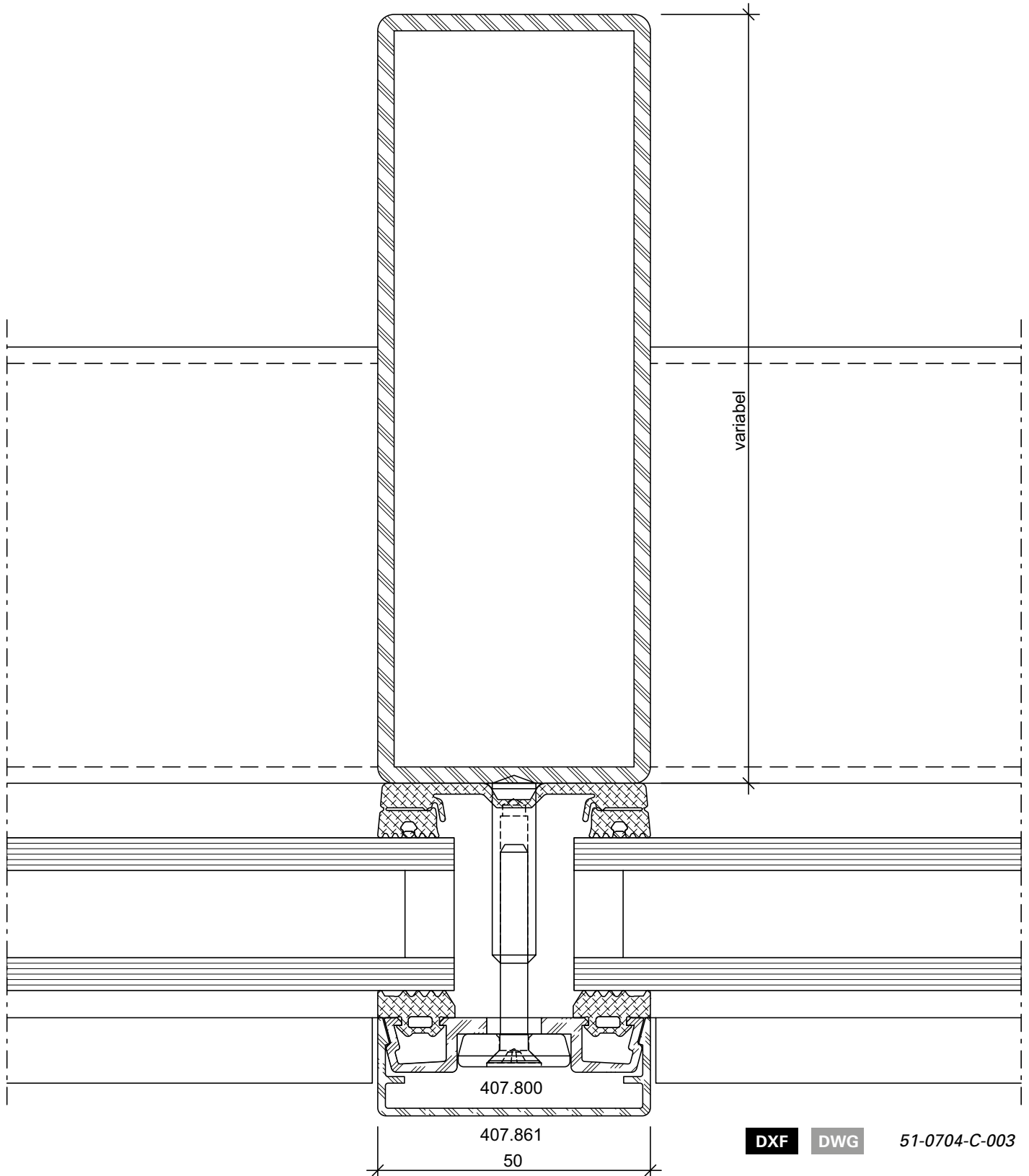

DXF

DWG

51-0704-C-003

Schnittpunkte im Massstab 1:1
Coupe de détails à l'échelle 1:1
Section details on scale 1:1

VISS Basic Fassade
VISS Basic façade
VISS Basic façade

Pfosten-Detail
Ansichtsbreite 50 mm
Schweissbolzen

Détail du montant
Largeur de face 50 mm
Goujon à souder

Detail of mullion
Width 50 mm
Welding stud

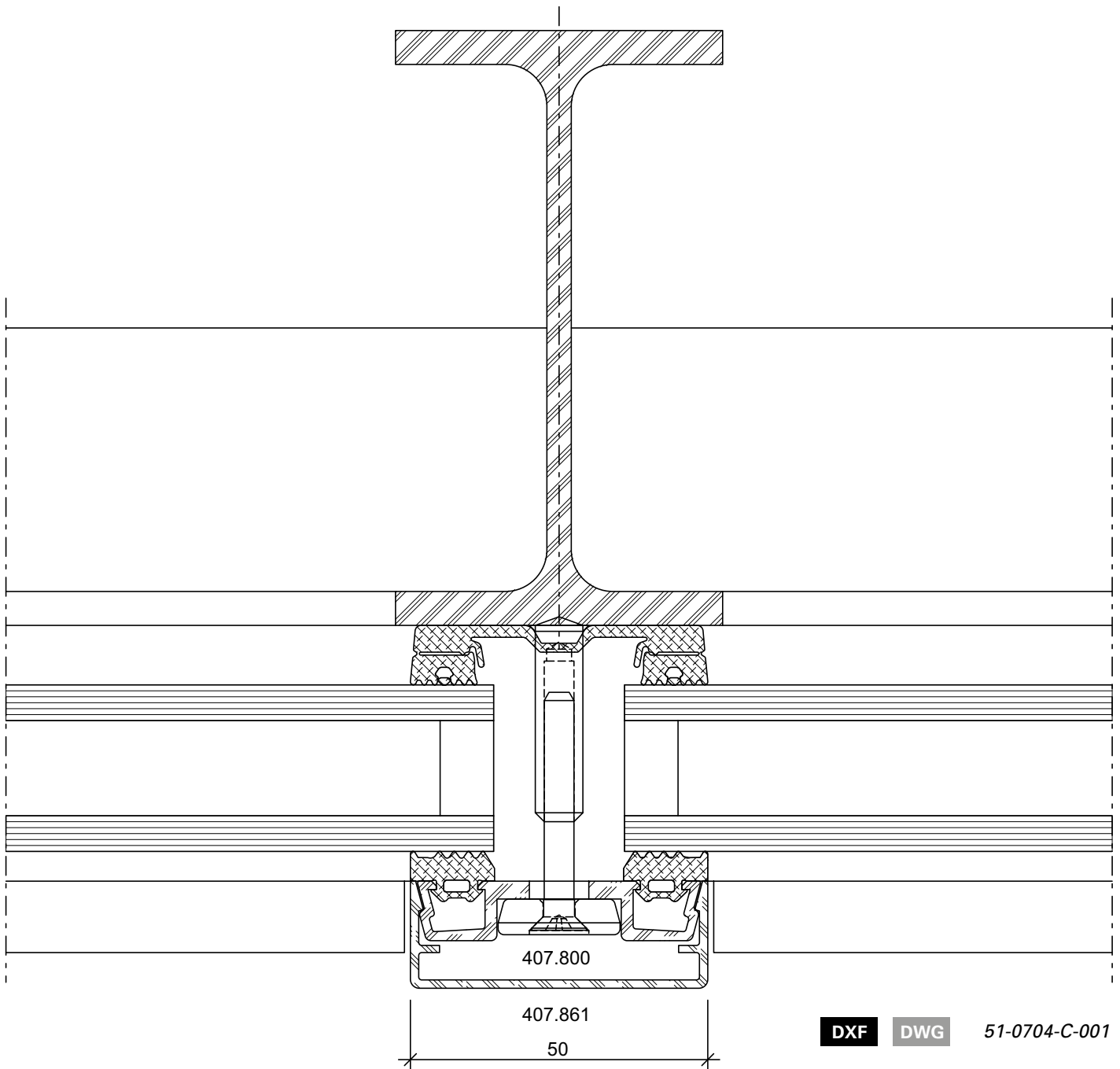

DXF **DWG** 51-0704-C-001

Schnittpunkte im Massstab 1:1
Coupe de détails à l'échelle 1:1
Section details on scale 1:1

VISS Basic Fassade
VISS Basic façade
VISS Basic façade

Riegel-Detail
Ansichtsbreite 50 mm
Schraubbolzen

Détail de la traverse
Largeur de face 50 mm
Goujon à visser

Detail of transom
Width 50 mm
Screw bolt

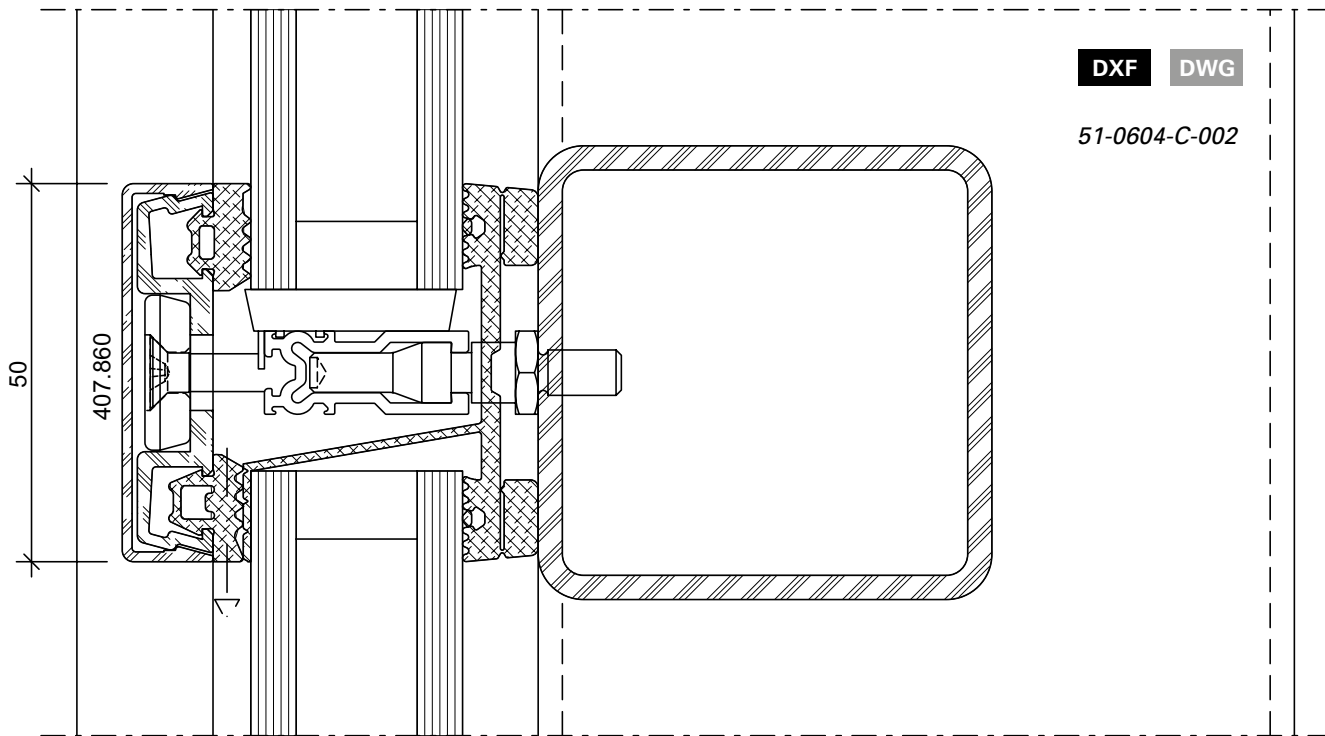

Riegel-Detail
Ansichtsbreite 50 mm
Schweissbolzen

Détail de la traverse
Largeur de face 50 mm
Goujon à souder

Detail of transom
Width 50 mm
Welding stud

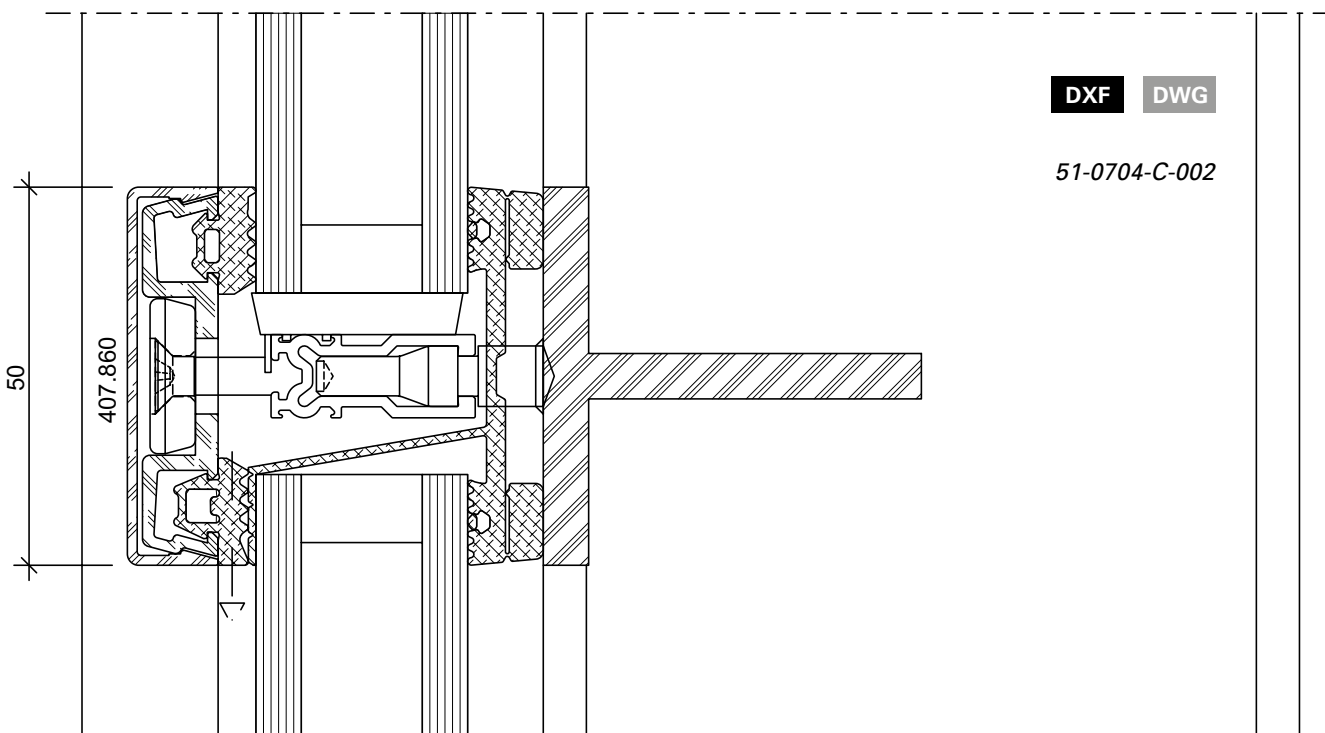

Schnittpunkte im Massstab 1:1
Coupe de détails à l'échelle 1:1
Section details on scale 1:1

VISS Basic Fassade
VISS Basic façade
VISS Basic façade

Pfosten-Detail
Ansichtsbreite 60 mm
Schraubbolzen

Détail du montant
Largeur de face 60 mm
Goujon à visser

Detail of mullion
Width 60 mm
Screw bolt

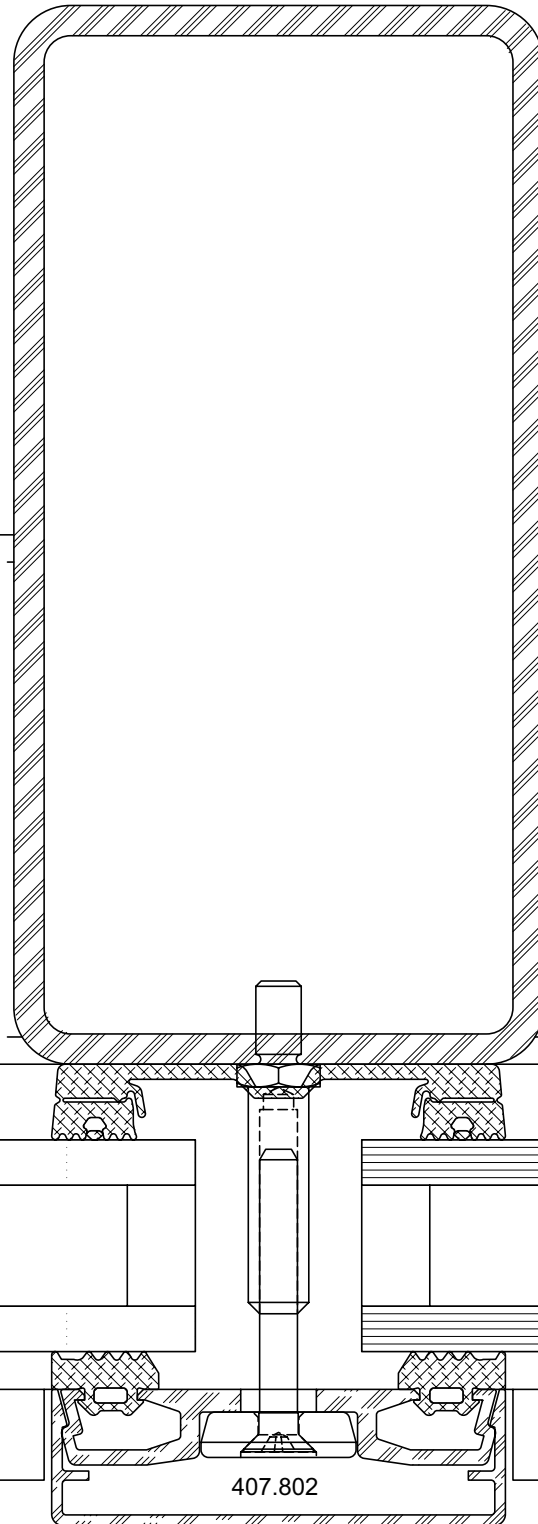

407.802

407.866

60

DXF

DWG

52-0201-C-001

Schnittpunkte im Massstab 1:1
Coupe de détails à l'échelle 1:1
Section details on scale 1:1

VISS Basic Fassade
VISS Basic façade
VISS Basic façade

Pfosten-Detail VISS I_xtra
Ansichtsbreite 60 mm
Schraubbolzen

Détail du montant VISS I_xtra
Largeur de face 60 mm
Goujon à visser

Detail of mullion VISS I_xtra
Width 60 mm
Screw bolt

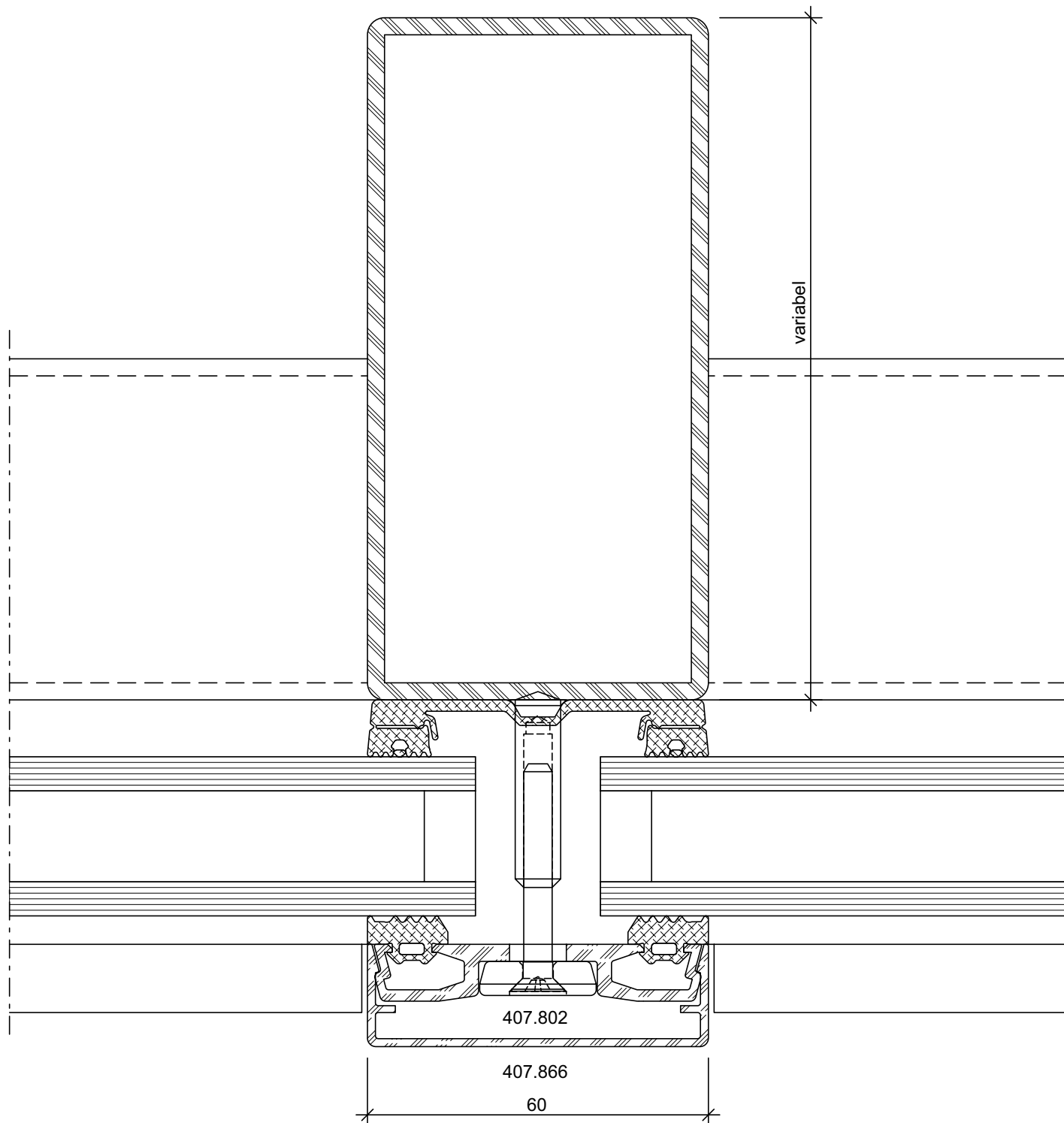

DXF

DWG

52-0401-C-003

Schnittpunkte im Massstab 1:1
Coupe de détails à l'échelle 1:1
Section details on scale 1:1

VISS Basic Fassade
VISS Basic façade
VISS Basic façade

Pfosten-Detail
Ansichtsbreite 60 mm
Schweissbolzen

Détail du montant
Largeur de face 60 mm
Goujon à souder

Detail of mullion
Width 60 mm
Welding stud

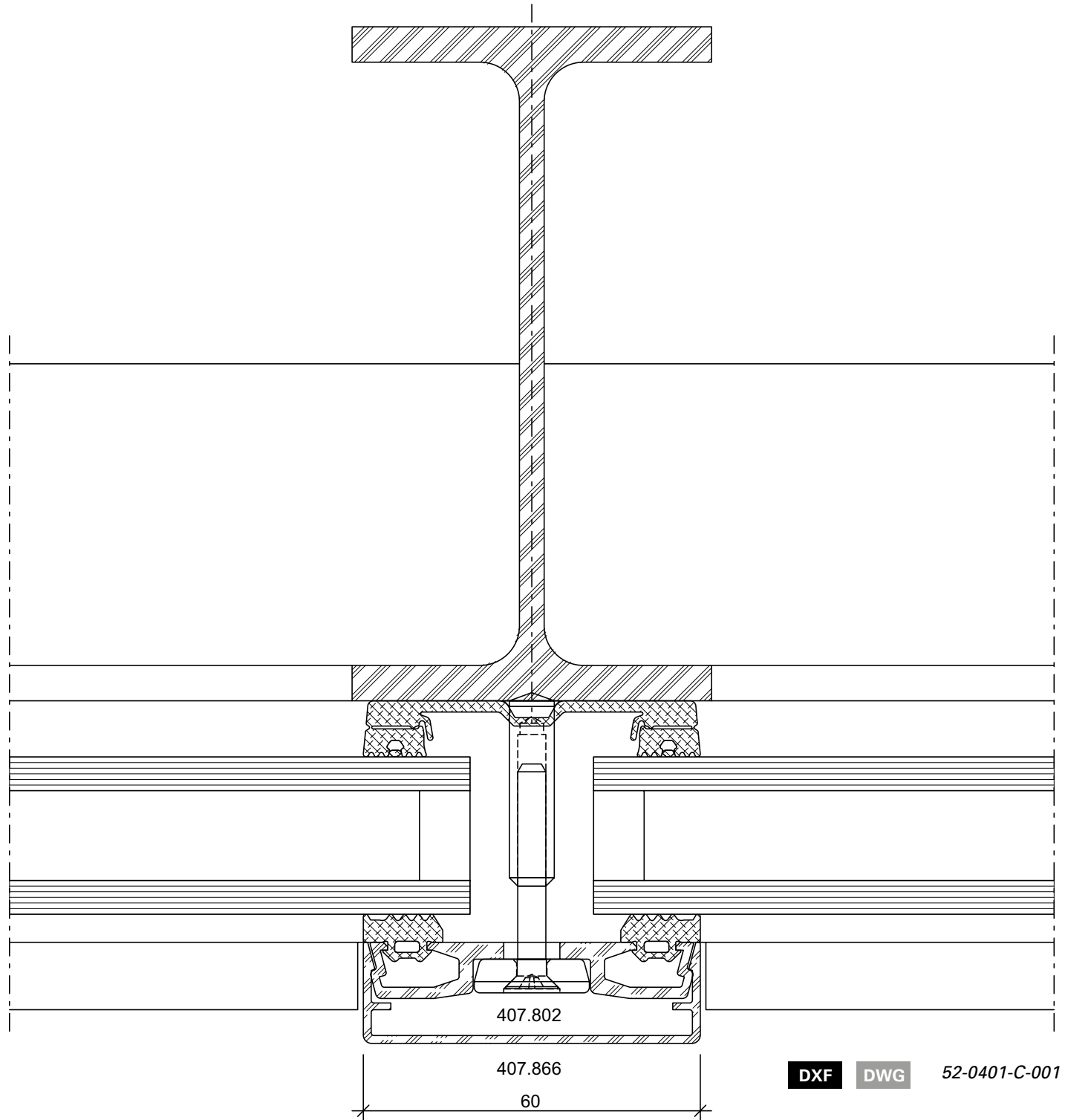

DXF DWG 52-0401-C-001

Schnittpunkte im Massstab 1:1
Coupe de détails à l'échelle 1:1
Section details on scale 1:1

VISS Basic Fassade
VISS Basic façade
VISS Basic façade

Riegel-Detail
Ansichtsbreite 60 mm
Schraubbolzen

Détail de la traverse
Largeur de face 60 mm
Goujon à visser

Detail of transom
Width 60 mm
Screw bolt

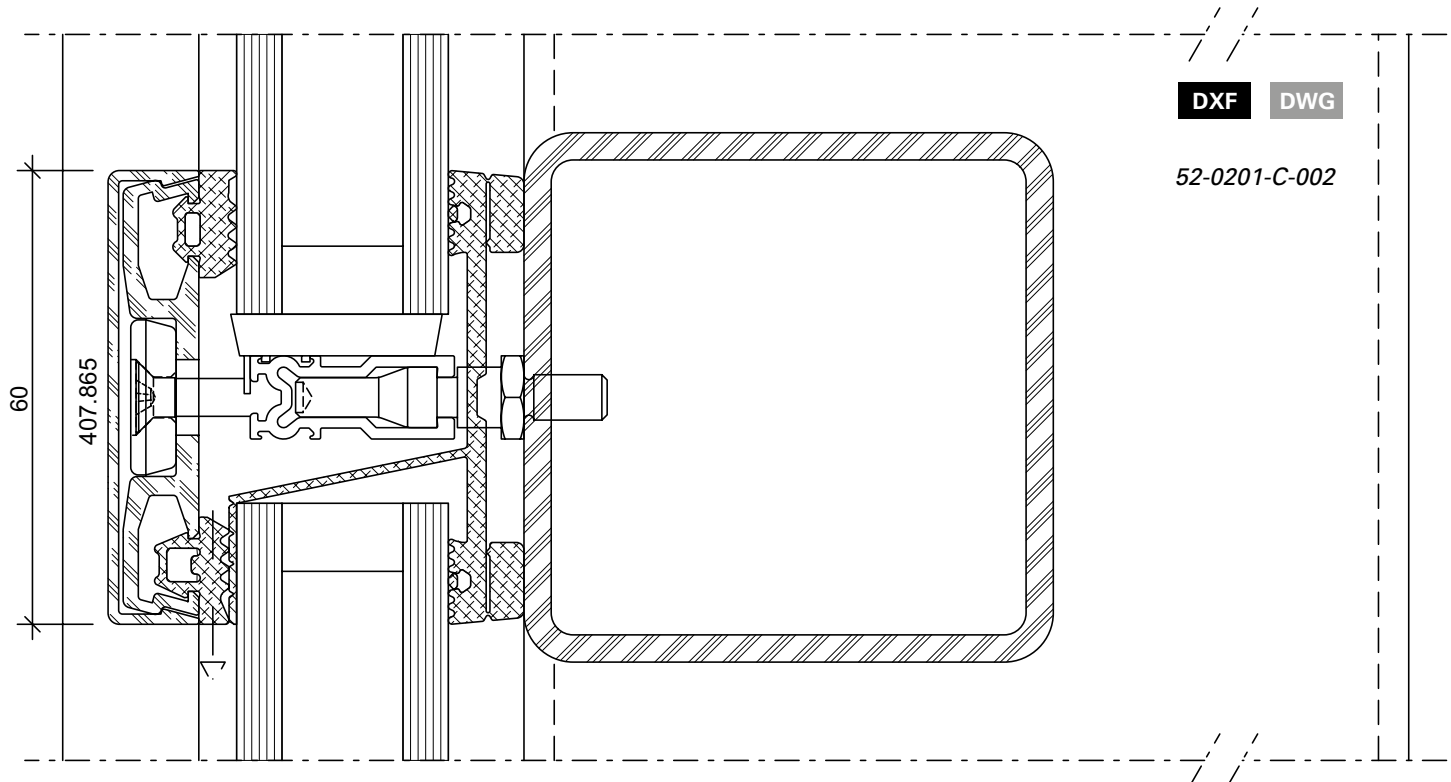

Riegel-Detail
Ansichtsbreite 60 mm
Schweissbolzen

Détail de la traverse
Largeur de face 60 mm
Goujon à souder

Detail of transom
Width 60 mm
Welding stud

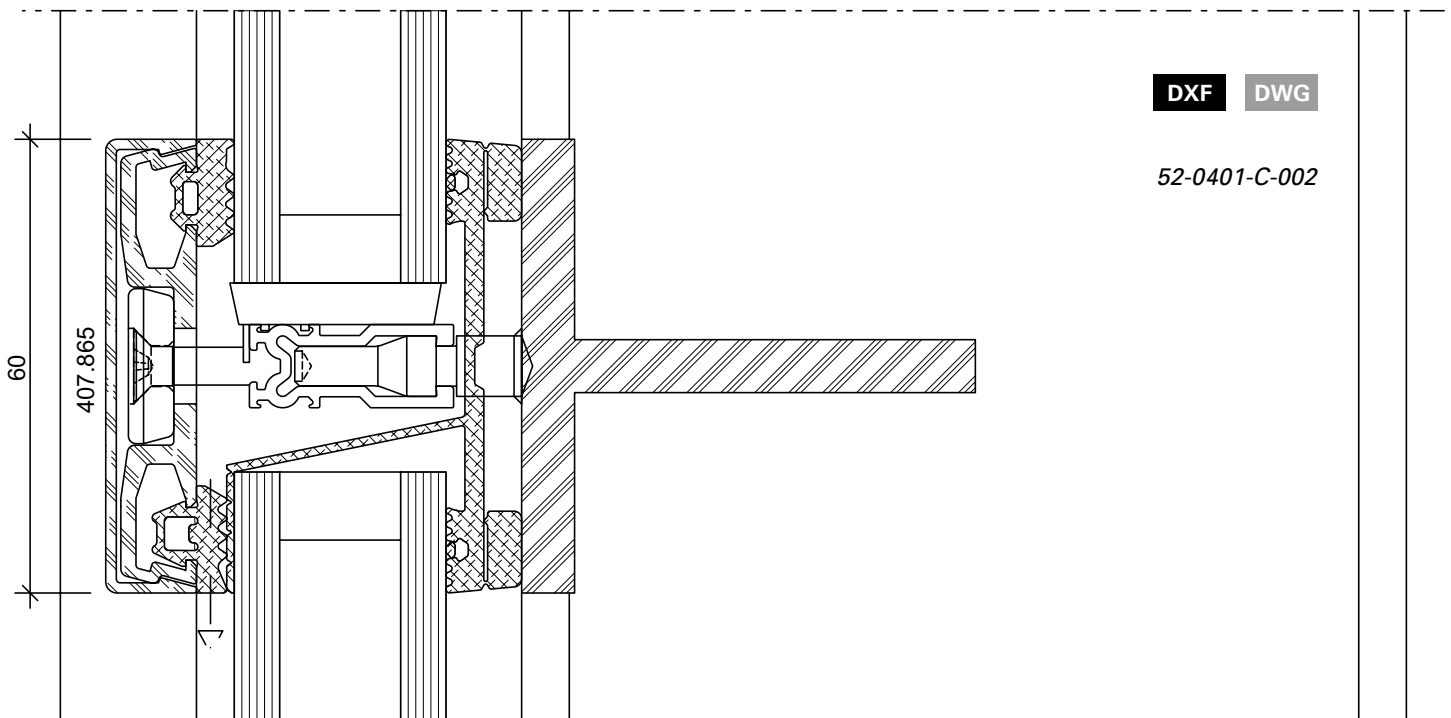

Einsatzelement
 Janisol HI Türe

Élément de remplissage
 Porte Janisol HI

Infill element
 Janisol HI door

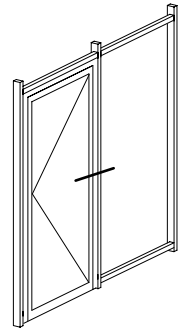
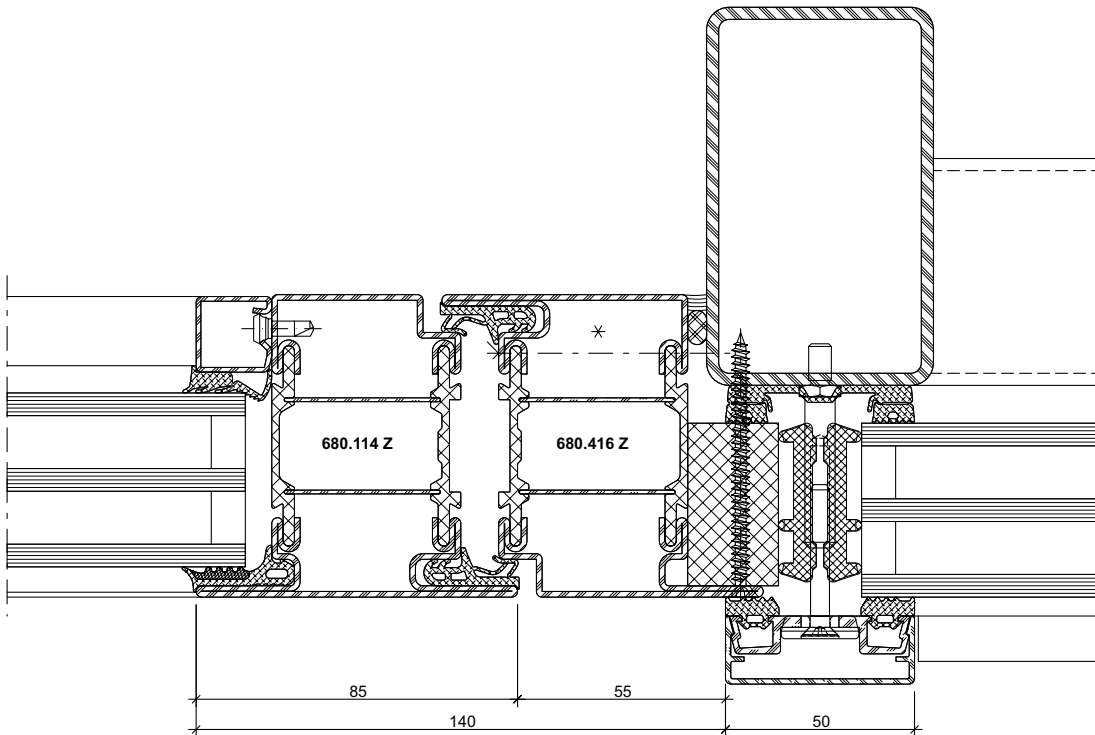

DXF DWG

53-0701-A-002

Einsatzelement
 Janisol HI Fenster

Élément de remplissage
 Fenêtre Janisol HI

Infill element
 Janisol HI window

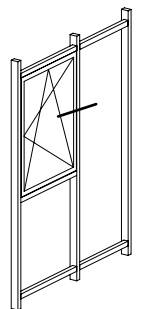
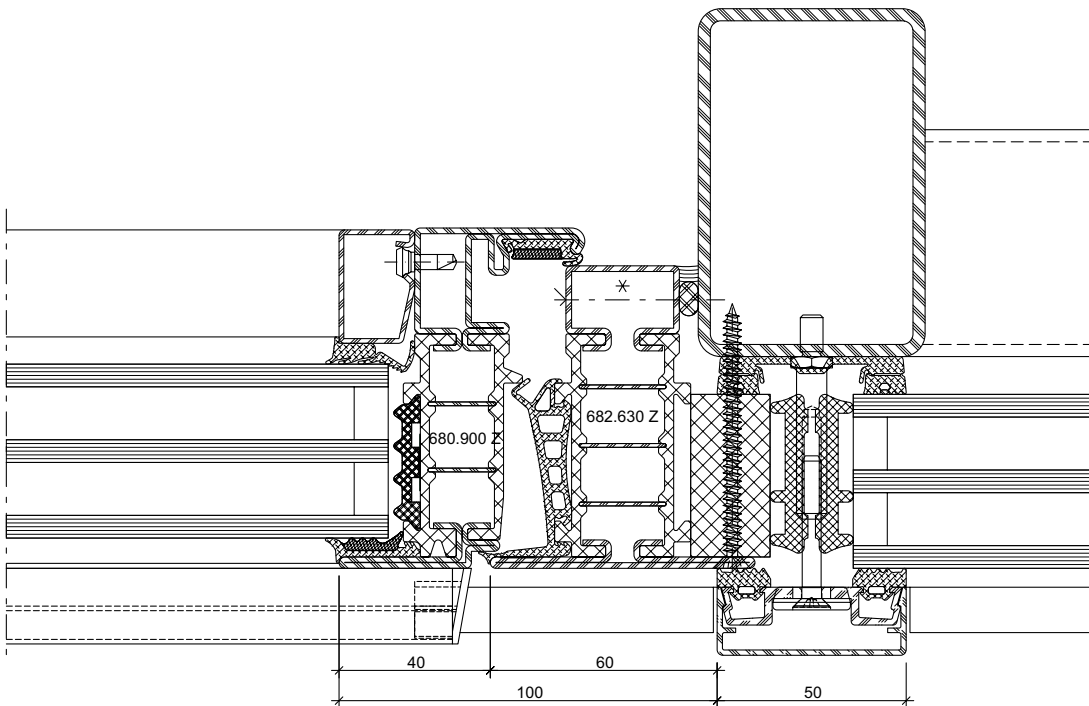

DXF DWG

53-0702-C-001

* Bei grossen, schweren und/oder stark frequentierten Türanlagen ist eine zusätzliche Verschraubung im Bandbereich erforderlich.

* Pour les portes lourdes de grandes dimensions et/ou fortement fréquentées, un vissage supplémentaire au niveau des paumelles est nécessaire.

* for large heavy and/or frequently used door systems, additional screw connections are required in the hinge area.

Einsatzelement
 Janisol Türe

Élément de remplissage
 Porte Janisol

Infill element
 Janisol door

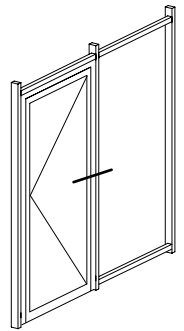
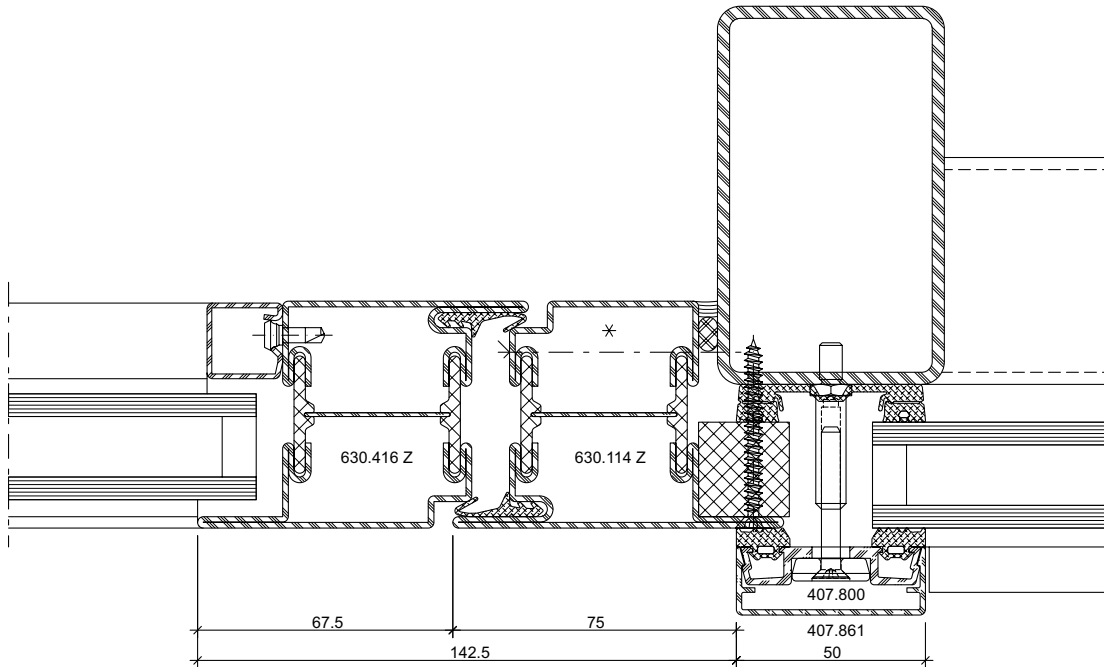

DXF DWG

53-0703-C-001

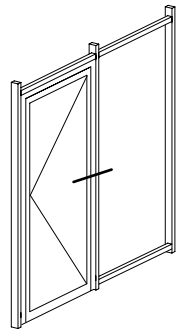
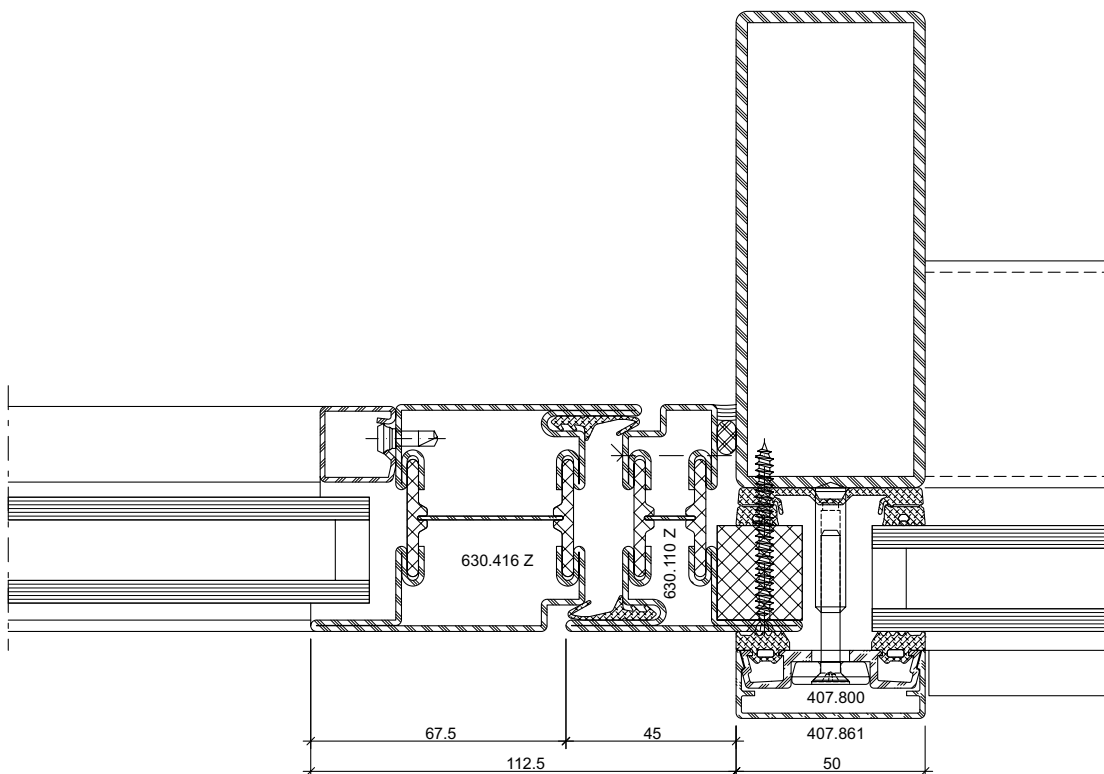

DXF DWG

53-0801-C-001

* Bei grossen, schweren und/oder stark frequentierten Türanlagen ist eine zusätzliche Verschraubung im Bandbereich erforderlich.

* Pour les portes lourdes de grandes dimensions et/ou fortement fréquentées, un vissage supplémentaire au niveau des paumelles est nécessaire.

* for large heavy and/or frequently used door systems, additional screw connections are required in the hinge area.

Einsatzelement Fenster
Janisol Primo

Élément de remplissage
Janisol Primo

Infill element
Janisol Primo

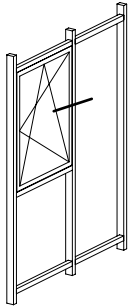
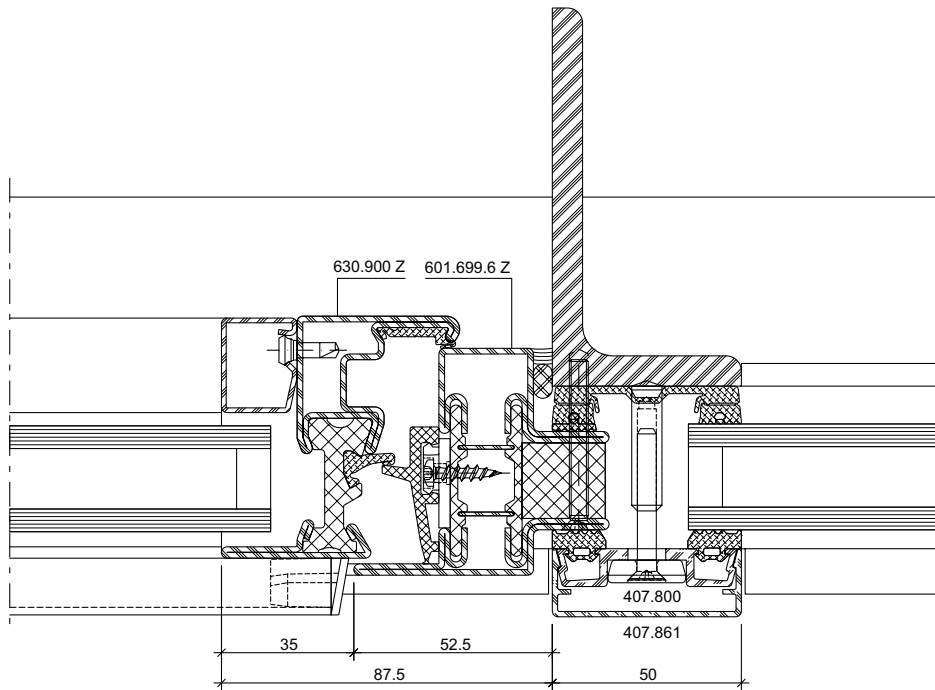

DXF DWG

53-0802-C-001

Einsatzelement Fenster
Janisol Arte 66

Élément de remplissage
Janisol Arte 66

Infill element
Janisol Arte 66

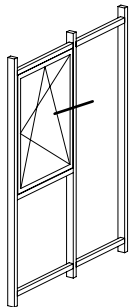
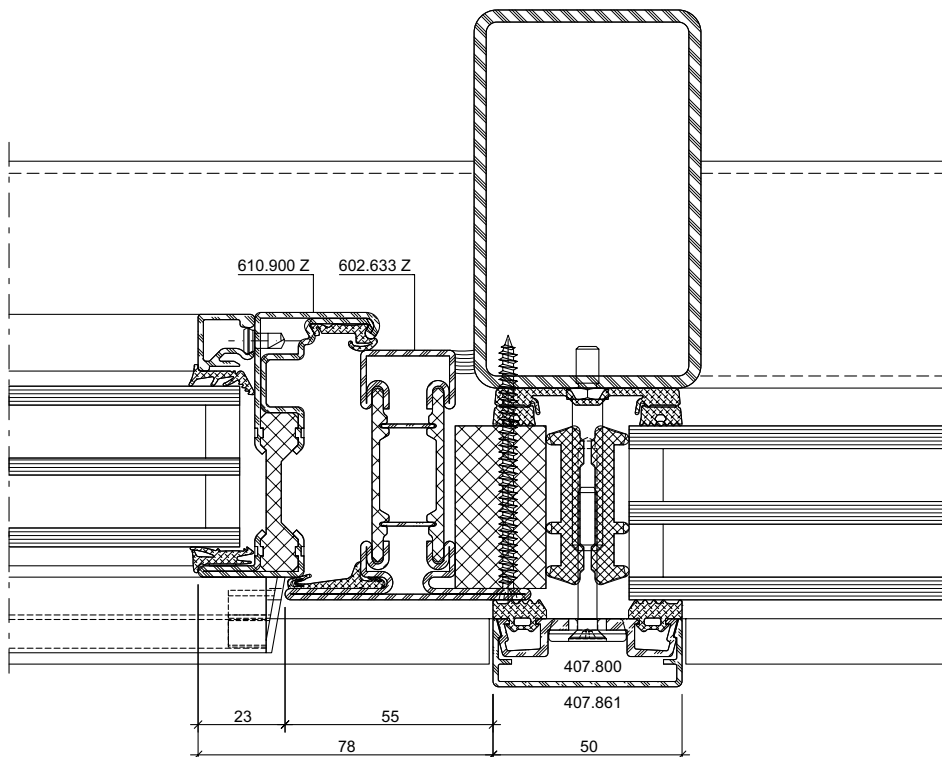

DXF DWG

53-0706-A-001

Einsatzelement Fenster
Janisol Arte 2.0

Élément de remplissage
Janisol Arte 2.0

Infill element
Janisol Arte 2.0

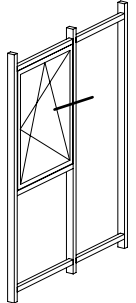
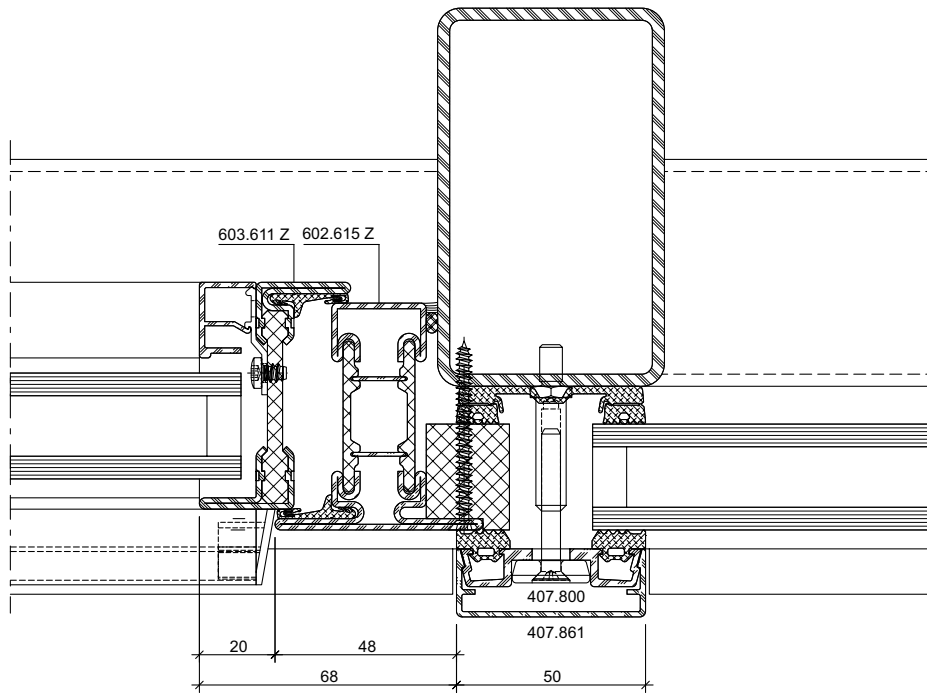

DXF DWG

53-0705-A-001

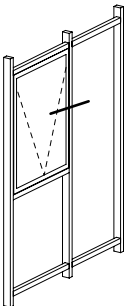
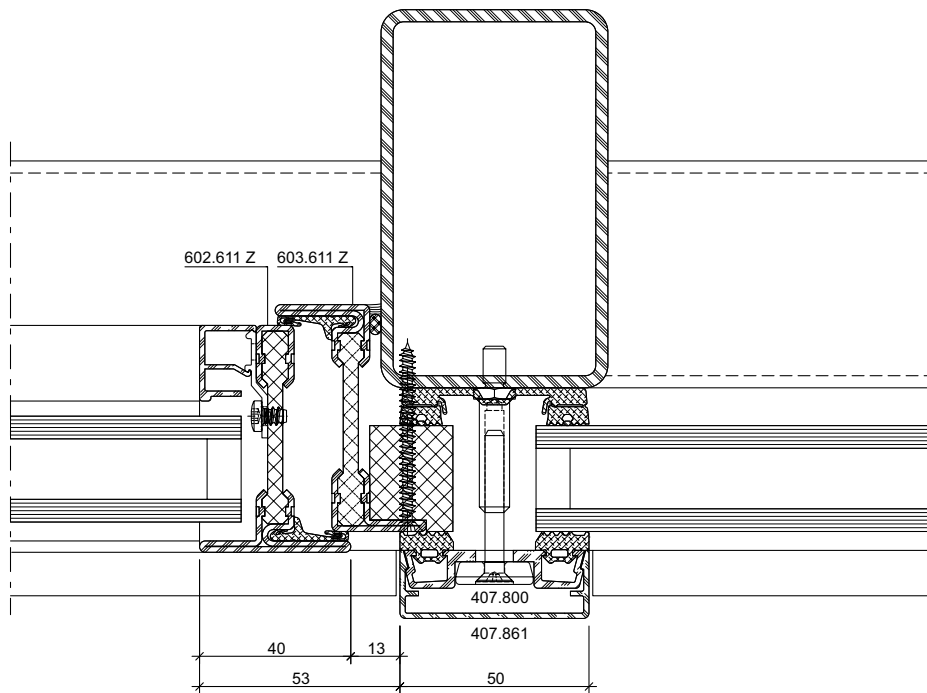

DXF DWG

53-0705-A-002

Aussenecke 90°

Angle extérieur 90°

Outer corner 90°

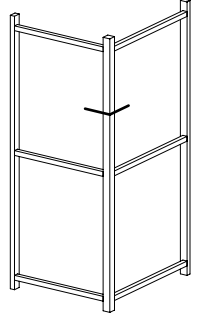
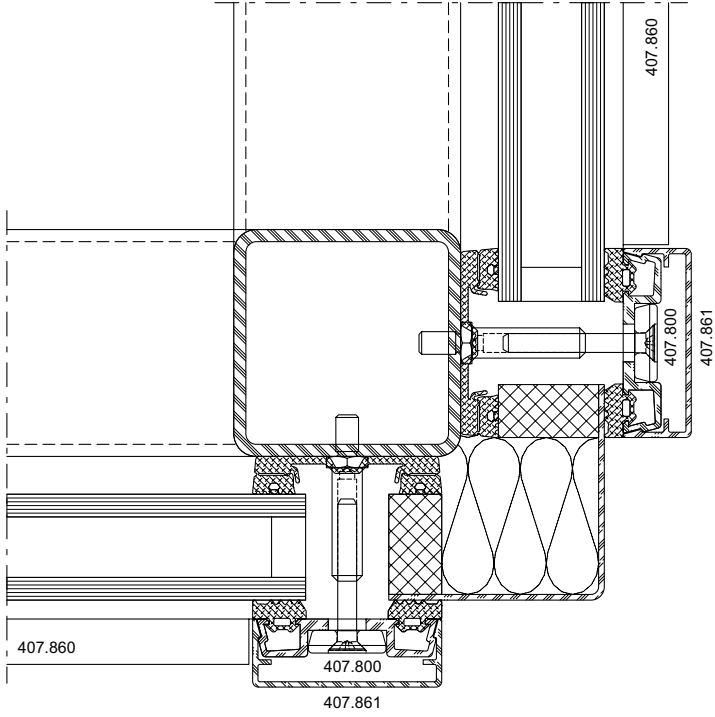

DXF DWG

51-0604-K-001

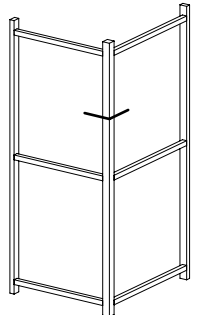
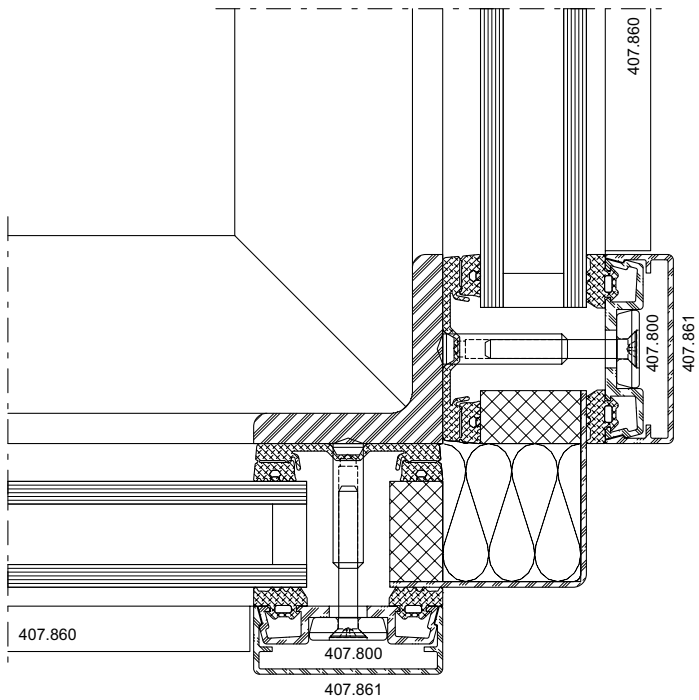

DXF DWG

51-0704-K-001

Aussenecke 135°

Angle extérieur 135°

Outer corner 135°

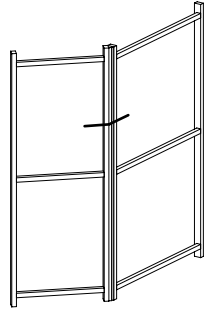
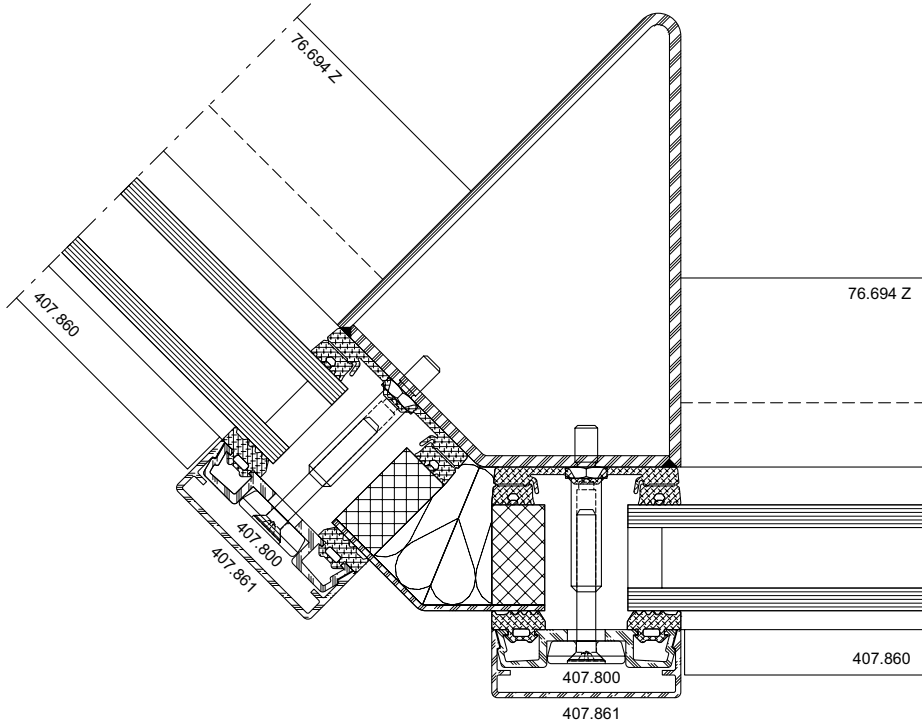

DXF DWG

51-0604-K-002

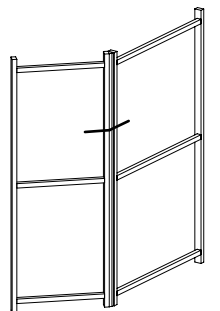
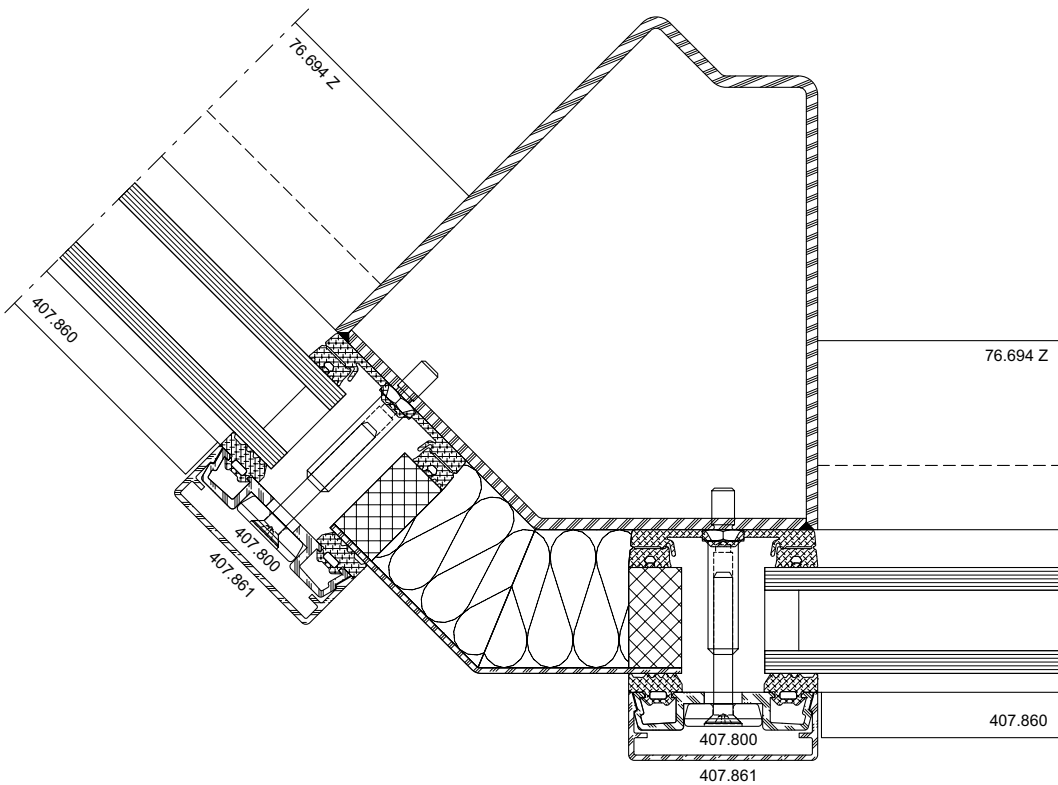

DXF DWG

51-0604-K-003

Anschlüsse am Bau im Masstab 1:2
Raccords au mur à l'échelle 1:2
Attachment to structure on scale 1:2

VISS Basic Fassade
VISS Basic façade
VISS Basic façade

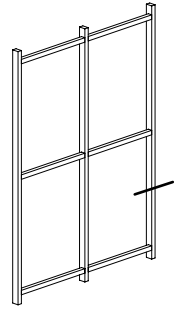
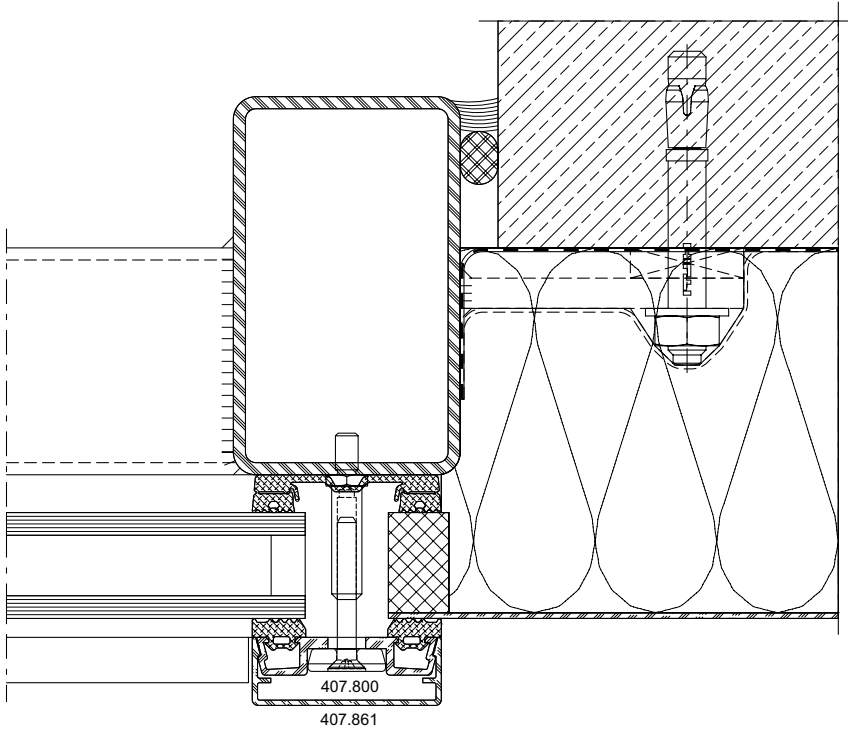

DXF DWG

51-0604-A-001

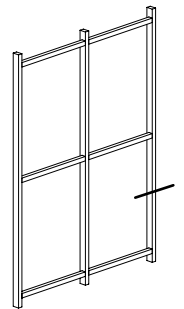
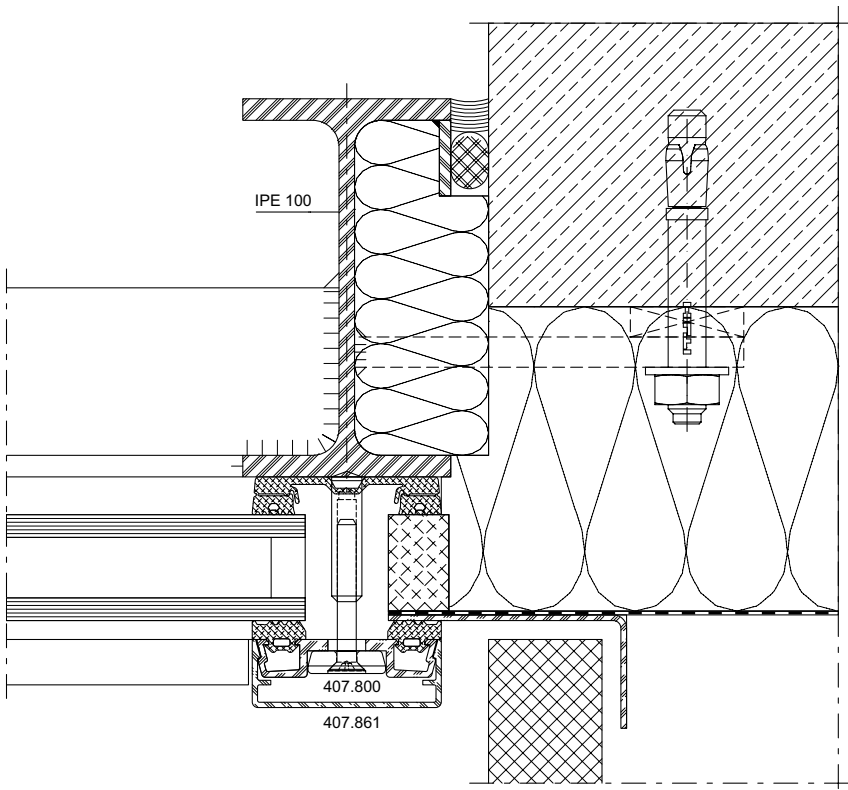

DXF DWG

51-0704-A-001

Anschlüsse am Bau im Masstab 1:2
Raccords au mur à l'échelle 1:2
Attachment to structure on scale 1:2

VISS Basic Fassade
VISS Basic façade
VISS Basic façade

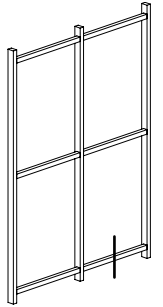
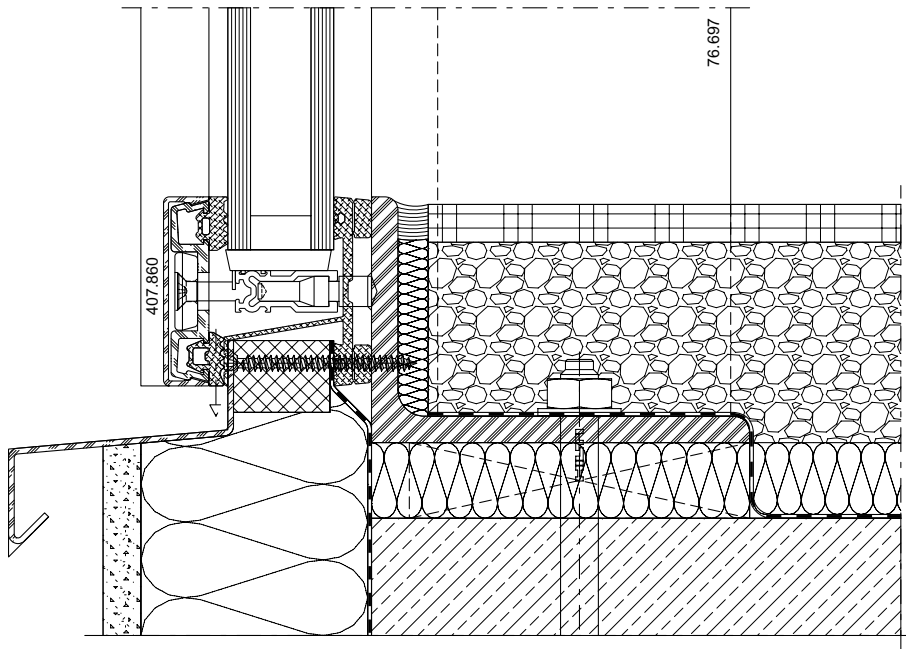

DXF DWG

51-0704-A-002

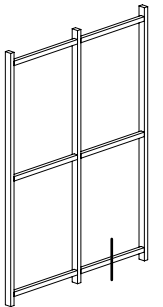
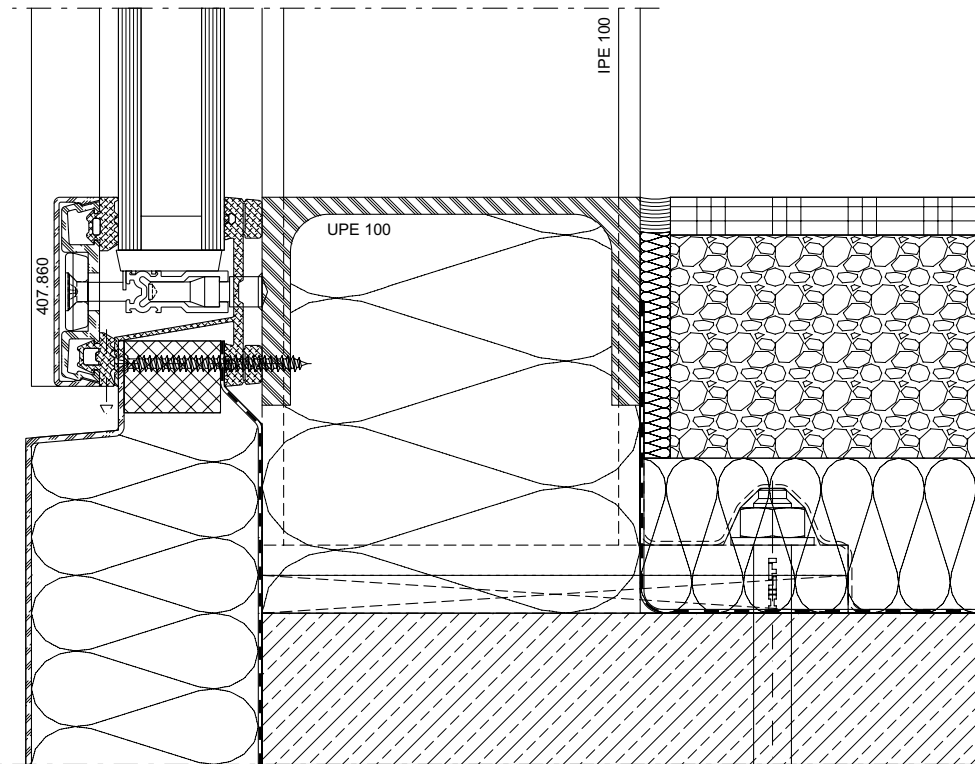

DXF DWG

51-0704-A-003

Anschlüsse am Bau im Massstab 1:2
Raccords au mur à l'échelle 1:2
Attachment to structure on scale 1:2

VISS Basic Fassade
VISS Basic façade
VISS Basic façade

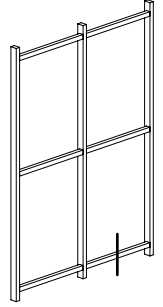
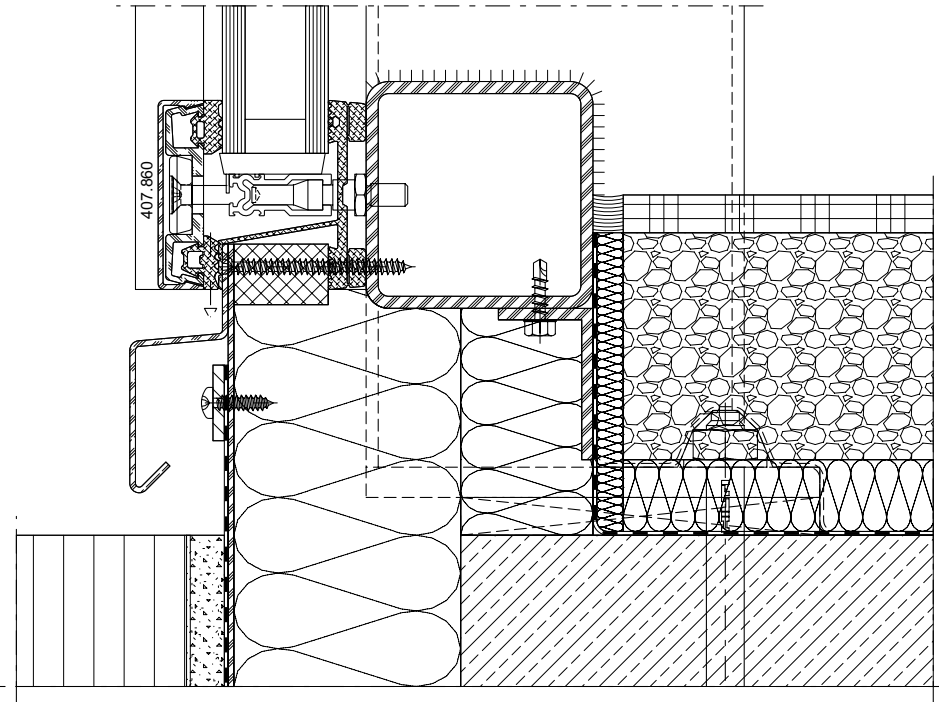

DXF DWG

51-0604-A-002

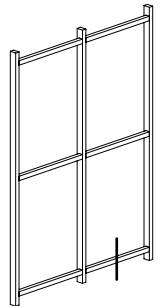
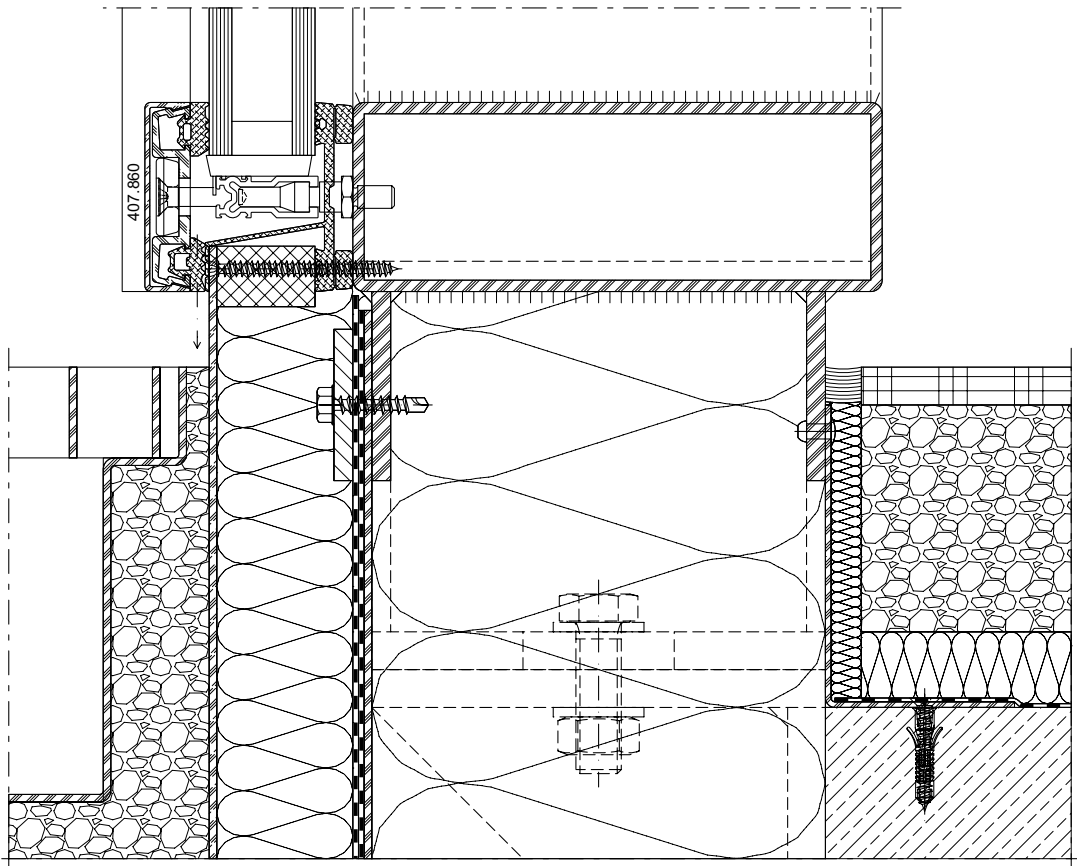

DXF DWG

51-0604-A-003

Anschlüsse am Bau im Masstab 1:2
Raccords au mur à l'échelle 1:2
Attachment to structure on scale 1:2

VISS Basic Fassade
VISS Basic façade
VISS Basic façade

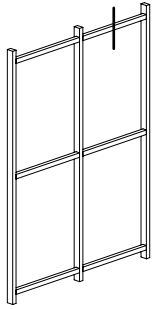
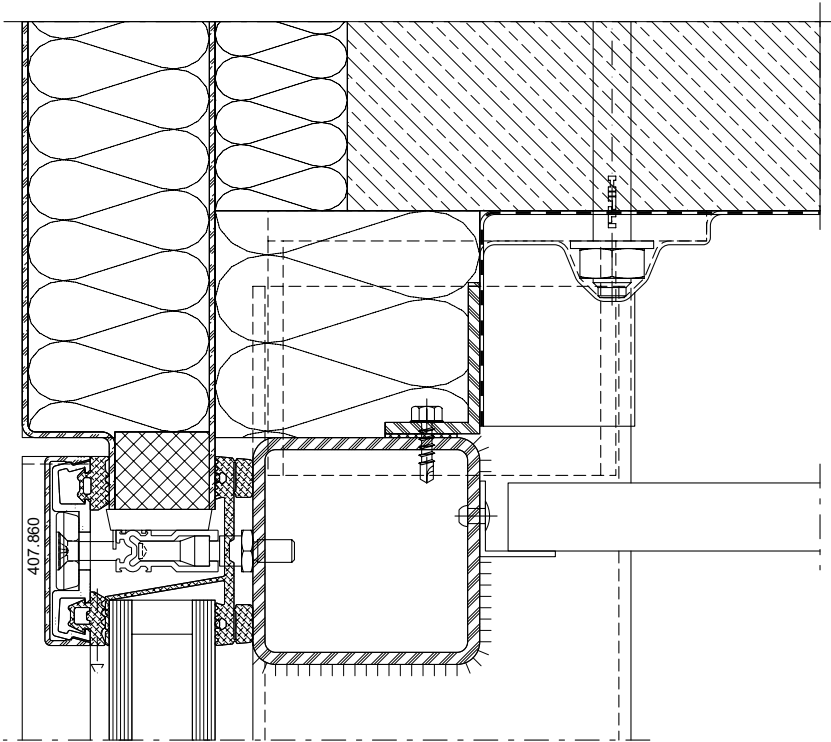

DXF DWG

51-0604-A-004

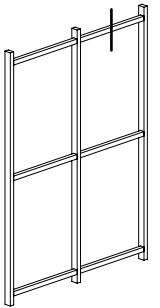
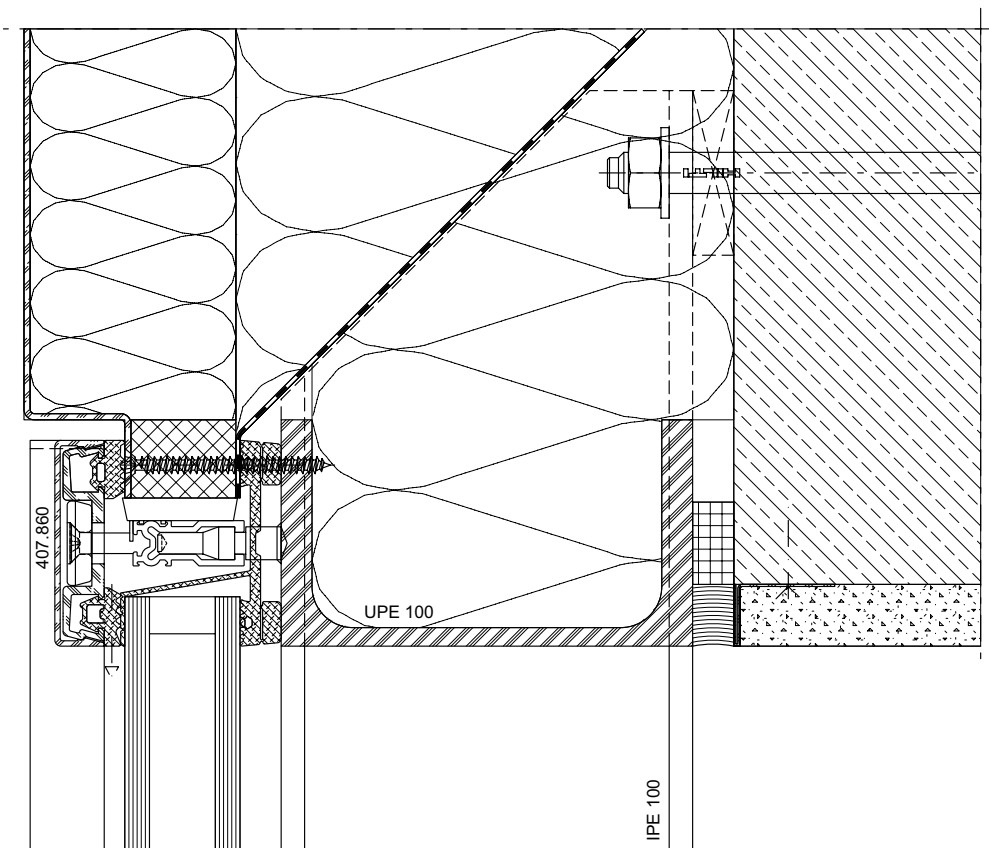

DXF DWG

51-0704-A-004

System-Hinweise

Remarques concernant les systèmes

System instructions

VISS Basic Fassade

VISS Basic façade

VISS Basic façade

VISS Basic HI 50 mm / 60 mm
mit DämmprofilVISS Basic HI 50 mm / 60 mm
avec noyau isolantVISS Basic HI 50 mm / 60 mm
with insulating coreU_f-Werte nach EN 10077-2Valeurs U_f selon EN 10077-2U_f values according to 10077-2

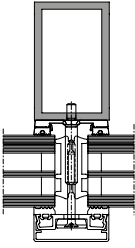
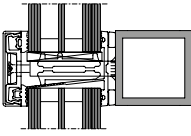
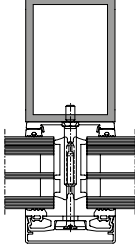
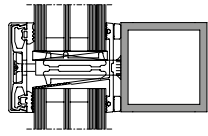
						
Glas Verre Glass	Pfosten 50/80/4 Montant 50/80/4 Mullion 50/8/40	Riegel 50/50/4 Traverse 50/50/4 Transom 50/50/4	Pfosten 60/80/4 Montant 60/80/4 Mullion 60/80/4	Riegel 60/60/4 Traverse 60/60/4 Transom 60/60/4		
30 mm	0,96 W/m²K	1,0 W/m²K	0,94 W/m²K	0,97 W/m²K		
40 mm	0,78 W/m²K	0,84 W/m²K	0,76 W/m²K	0,83 W/m²K		
50 mm	0,66 W/m²K	0,74 W/m²K	0,63 W/m²K	0,70 W/m²K		
60 mm	0,59 W/m²K	0,65 W/m²K	0,56 W/m²K	0,63 W/m²K		
70 mm	0,53 W/m²K	0,60 W/m²K	0,51 W/m²K	0,58 W/m²K		

Der Einfluss der Schrauben-
befestigung in Höhe von 0.30 W/m²K
ist berücksichtigt.

L'influence de la fixation à vis de
0.30 W/m²K est prise en compte.

The 0.30 W/m²K influence of the
screw fixing is taken into account.

System-Hinweise

Remarques concernant les systèmes

System instructions

VISS Basic Fassade

VISS Basic façade

VISS Basic façade

VISS Basic 50 mm / 60 mm

U_f-Werte nach EN 10077-2

VISS Basic 50 mm / 60 mm

Valeurs U_f selon EN 10077-2

VISS Basic 50 mm / 60 mm

U_f values according to 10077-2

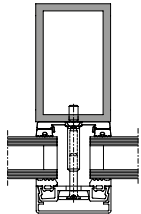
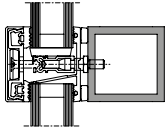
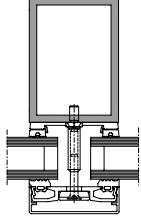
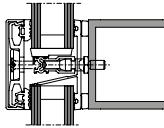
						
Glas Verre Glass	Pfosten 50/80/4 Montant 50/80/4 Mullion 50/8/40	Riegel 50/50/4 Traverse 50/50/4 Transom 50/50/4	Pfosten 60/80/4 Montant 60/80/4 Mullion 60/80/4	Riegel 60/60/4 Traverse 60/60/4 Transom 60/60/4		
20 mm	1,8 W/m²K	1,5 W/m²K	1,7 W/m²K	1,4 W/m²K		
30 mm	1,6 W/m²K	1,3 W/m²K	1,5 W/m²K	1,2 W/m²K		
40 mm	1,5 W/m²K	1,3 W/m²K	1,5 W/m²K	1,1 W/m²K		
50 mm	1,4 W/m²K	1,2 W/m²K	1,2 W/m²K	1,1 W/m²K		
60 mm	1,4 W/m²K	1,2 W/m²K	1,2 W/m²K	1,0 W/m²K		
70 mm	1,3 W/m²K	1,2 W/m²K	1,1 W/m²K	1,0 W/m²K		

Der Einfluss der Schraubenbefestigung in Höhe von 0.30 W/m²K ist berücksichtigt.

L'influence de la fixation à vis de 0.30 W/m²K est prise en compte.

The 0.30 W/m²K influence of the screw fixing is taken into account.

VISS Basic Fassade
VISS Basic façade
VISS Basic façade
