

VISS SG / VISS Semi SG

Structural Glazing Fassaden

VISS SG / VISS Semi SG

Façades toute en verre

VISS SG / VISS Semi SG

Structural glazing façades

Inhaltsverzeichnis
Sommaire
Content

VISS SG-Fassaden
Façades VISS SG
VISS SG façades

VISS SG **VISS SG** **VISS SG** **2**

VISS Semi SG **VISS Semi SG** **VISS Semi SG** **27**

VISS Basic SG **VISS Basic SG** **VISS Basic SG** **55**

VISS Basic Semi SG **VISS Basic Semi SG** **VISS Basic Semi SG** **61**

Alle Ausführungen dieser Dokumentation haben wir sorgfältig und nach bestem Wissen zusammengestellt. Wir können aber keine Verantwortung für die Benützung der vermittelten Vorschläge und Daten übernehmen. Wir behalten uns technische Änderungen ohne Vorankündigung vor.
Aktuelle Version auf www.jansen.com

Nous avons apporté le plus grand soin à l'élaboration de cette documentation. Cependant, nous déclinons toute responsabilité pour l'utilisation faite de nos propositions et de nos données.
Nous nous réservons le droit de procéder à des modifications techniques sans préavis.
Version actuelle sur www.jansen.com

All the information contained in this documentation is given to the best of our knowledge and ability. However, we decline all responsibility for the use made of these suggestions and data.
We reserve the right to effect technical modifications without prior warning.
Current version available at www.jansen.com

Inhaltsverzeichnis Sommaire Content		VISS SG-Fassaden Façades VISS SG VISS SG façades	
Systemübersicht Merkmale Leistungseigenschaften	Sommaire du système Caractéristiques Caractéristiques de performance	Summary of system Characteristics Performance characteristics	4
Profilsortiment	Assortiment de profilé	Range of profiles	9
Beispiele Schnittpunkte Konstruktionsdetails Anschlüsse am Bau	Exemples Coupe de détails Détails de construction Raccords au mur	Examples Section details Construction details Attachment to structure	12
Systemhinweise	Remarque concernant les systèmes	System instructions	22

Merkmale

Caractéristiques

Characteristics

VISS SG-Fassaden

Façades VISS SG

VISS SG façades

- CE-Kennzeichnung nach ETAG 002
- ETA Zulassung für Vorhangfassade und Dachverglasung
- Glasflächen bis 2.5 x 5 m (la x h) bzw. 5 x 2.5 m (b x h)
- Mechanische Sicherung der Gläser - kein Verkleben notwendig
- Zweifach- und Dreifach-Isolierglas Glasstärken bis 30 - 70 mm
- Realisierung von VISS SG und VISS Semi-SG Lösungen
- Einfache Realisierung von Ganzglas-Ecklösungen
- Kombinierbar mit der VISS Standard Fassade
- Absturzsichernde Verglasung nach DIN 18008
- Marquage CE selon ETAG 002
- Homologation ETA pour façade-rideau et verrière
- Surfaces vitrées jusqu'à 2.5 x 5 m (la x h) et 5 x 2.5 m (la x h)
- Sécurité mécanique des vitres - inutile de coller
- Verre isolant double ou triple, épaisseurs de verre jusqu'à 30 à 70 mm
- Réalisation de solutions VISS SG et VISS Semi SG
- Réalisation simple d'angles tout verre
- Combinable avec la façade VISS standard
- Sécurité anti-chute des vitrages selon DIN 18008
- CE marking in accordance with ETAG 002
- ETA approval for curtain walling and roof glazing
- Glass surfaces of up to 2.5 x 5 m (w x h) or 5 x 2.5 m (w x h)
- Mechanical fixing of the glass - no bonding required
- Double and triple insulating glass thicknesses of up to 30 - 70 mm
- Implementation of VISS SG and VISS Semi SG solutions
- Easy implementation of all-glass corner solutions
- Can be combined with the VISS Standard façade
- protecting glazing against falling out in accordance with DIN 18008

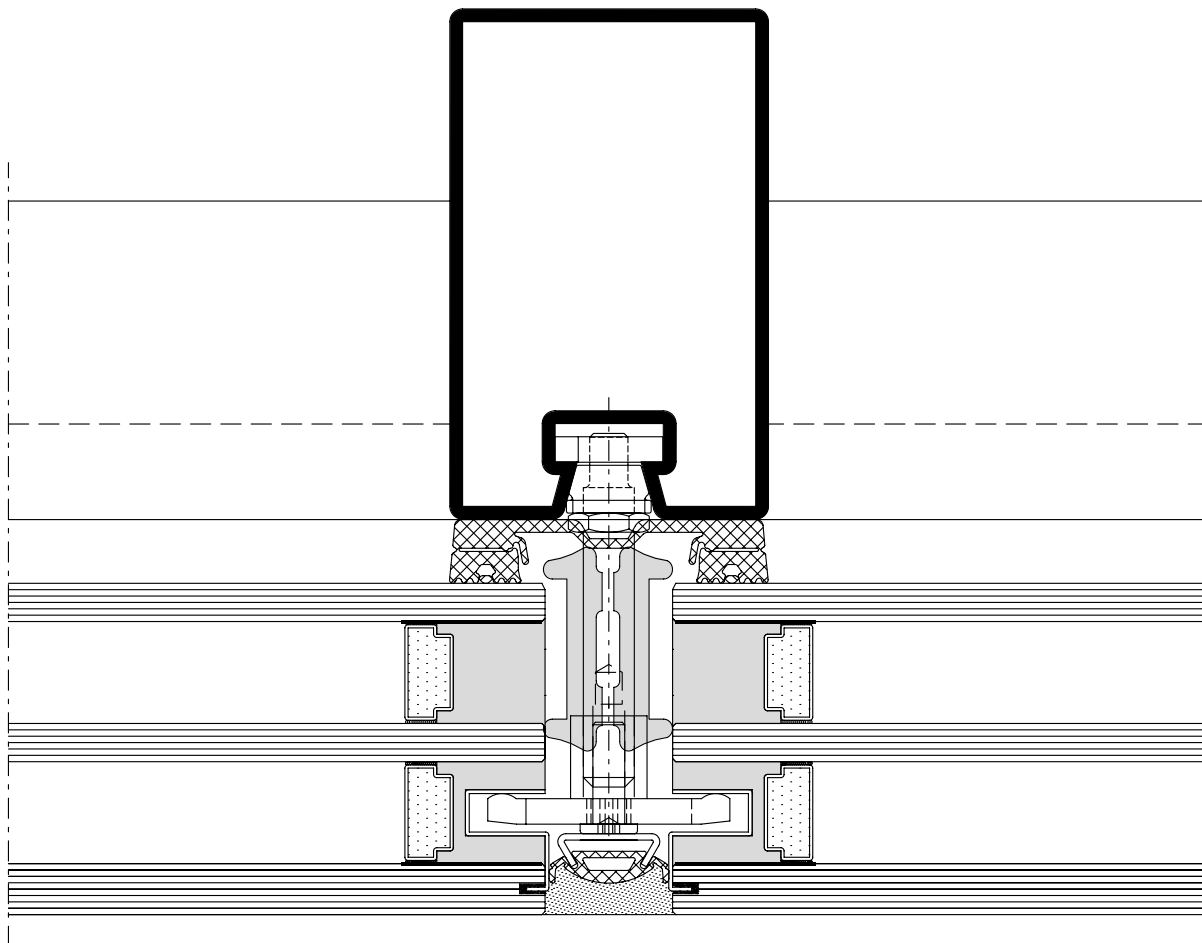

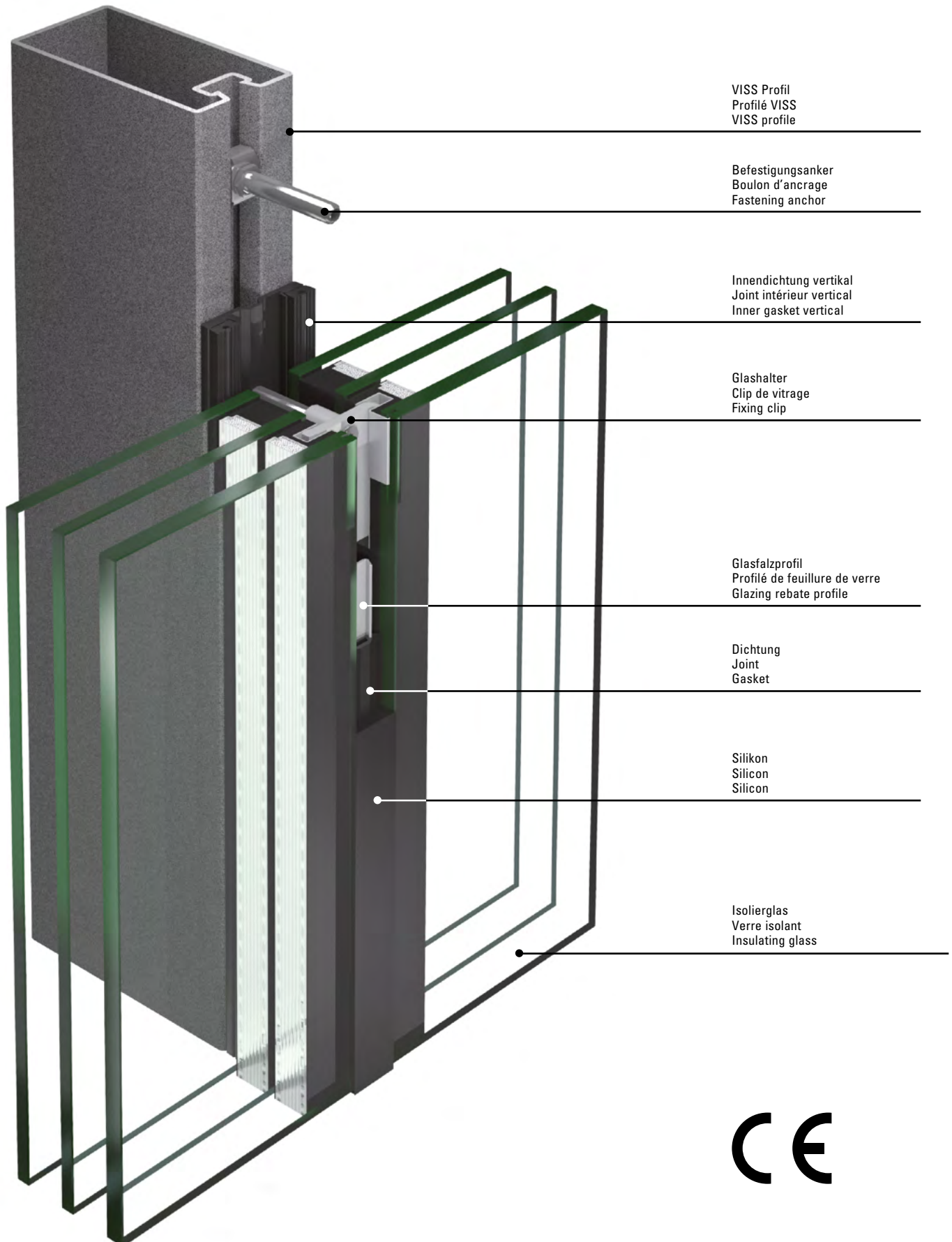

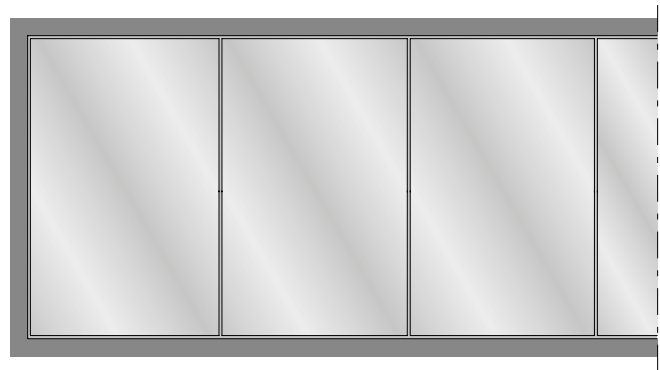
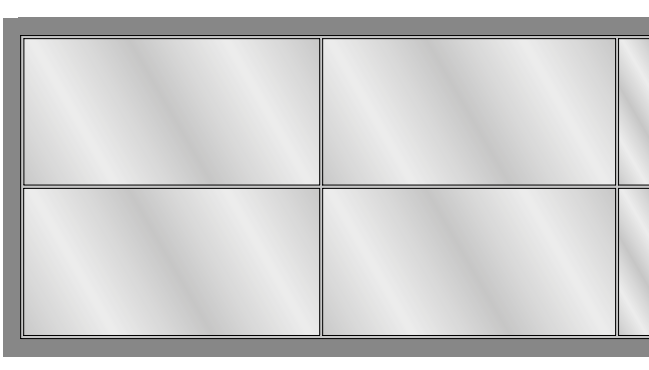

In einzelnen Ländern (z.B. Deutschland oder Österreich) muss die äussere Scheibe von Ganzglasfassaden mechanisch gesichert werden. Für VISS SG stehen hierzu grundsätzlich diese beiden Varianten zur Verfügung.

Dans certains pays (par ex. Allemagne ou Autriche), il faut assurer un calage mécanique de la vitre extérieure de façades entièrement vitrées. Dans le cas de VISS SG, il existe à cet effet les deux variantes suivantes.

In some countries (e.g. Germany and Austria) the exterior pane of all-glass facades must be secured mechanically. For VISS SG the following two options are available.

Beide Verglasungen erfüllen die Anforderungen an vorgefertigte absturzsichernde Verglasungen nach DIN 18008 Teil 4, wie es in Deutschland gefordert ist.

Les deux types de vitrage satisfont au «Règlement technique pour la sécurité anti-chute des vitrages» (TRAV), exigé en Allemagne

Both types of glazing fulfil the «Technical regulations for protecting glazing against falling out» (TRAV) required in Germany.

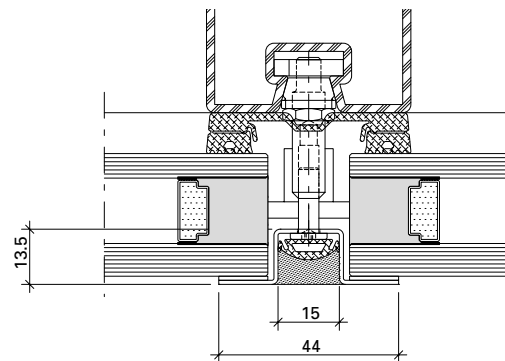
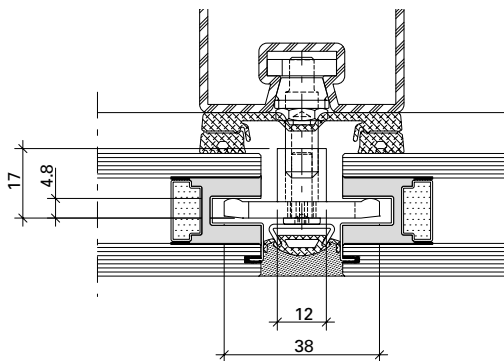

Sicherung der Aussenscheibe durch integrierte Nothalter mit VARIO DZ bzw. VARIO S-FOR. Vorteil dieser Lösung: die mechanische Sicherung ist praktisch unsichtbar.







Sicherung der Aussenscheibe durch eine mechanische Aussenklammer in Verbindung mit VARIO II. Kostengünstige Alternative, wobei die mechanische Sicherung dezent sichtbar ist.

Blocage de la vitre extérieure avec des cales de sécurité intégrées avec VARIO DZ ou VARIO S-FOR. L'avantage de cette solution est de rendre le calage mécanique pratiquement invisible.

Blocage de la vitre extérieure avec une attache extérieure mécanique en association avec VARIO II. Alternative économique, le blocage mécanique se caractérisant par une visibilité discrète.

Securing the exterior pane using integrated fastening devices with VARIO DZ or VARIO S-FOR. Advantage of this solution: the mechanical anchor is almost completely concealed.

Securing the exterior pane using a mechanical external bracket in combination with VARIO II. An economical alternative; the elegant mechanical bracket is visible.

	Prüfungen (Prüfnorm) Essais (Norme d'essai) Tests (Test standard)	Klassifizierungs-Norm Norme de classification Classification standard	Werte Valeurs Values
	Schlagregendichtheit (EN 12155) Etanchéité à la pluie battante (EN 12155) Watertightness (EN 12155)	EN 12154	RE 1200
	Widerstand bei Windlast (EN 12179) Résistance à la pression du vent (EN 12179) Resistance to wind load (EN 12179)	EN 13116	Bemessungslast 2 kN/m ² Charge de calcul 2 kN/m ² Designed load 2 kN/m ²
	Luftdurchlässigkeit (EN 12153) Perméabilité à l'air (EN 12153) Air permeability (EN 12153)	EN 12152	Klasse AE Classe AE Class AE
	Wärmedurchgangskoeffizient (EN 13947) Transmission thermique (EN 13947) Thermal production (EN 13947)	EN ISO 10077-2	ab $U_f > 0.50 \text{ W/m}^2\text{K}$ dès $U_f > 0.50 \text{ W/m}^2\text{K}$ from $U_f > 0.50 \text{ W/m}^2\text{K}$
	Stoßfestigkeit Résistance au chocs Impact strength	EN 14019	Klasse E5 / I5 Classe E5 / I5 Class E5 / I5
	Technische Regeln für die Verwendung von absturz sichernden Verglasungen Règlement technique pour la sécurité anti-chute des vitrages The technical regulations for protecting glazing against falling out	DIN 18008-4	Kategorie A, C2, C3 Catégorie A, C2, C3 Category A, C2, C3
	Europäische technische Zulassung (ETA) Homologation technique européenne (ETA) European Technical Approval (ETA)	ETAG 002	ETA 13/0015

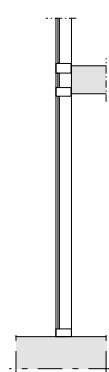
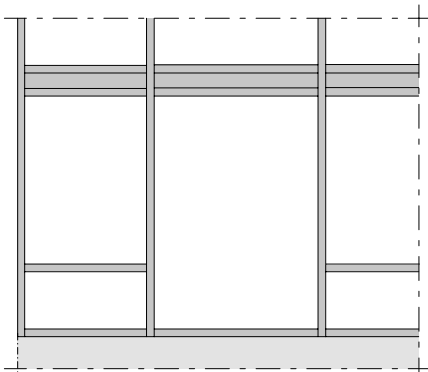
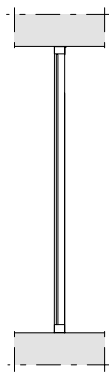
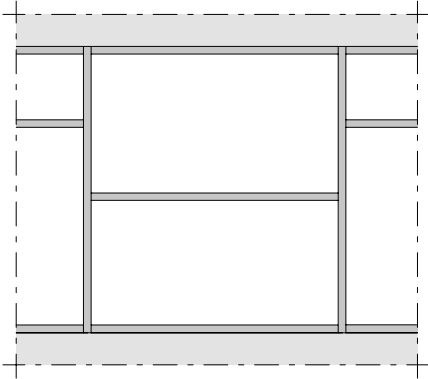
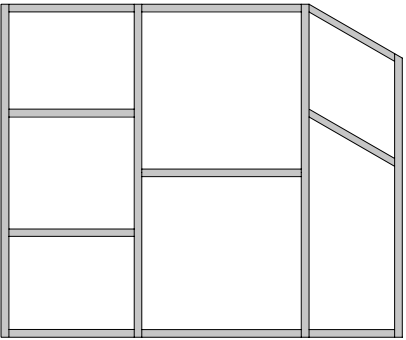
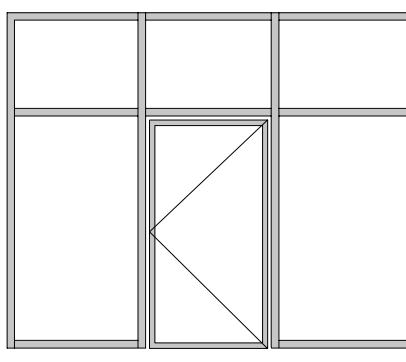
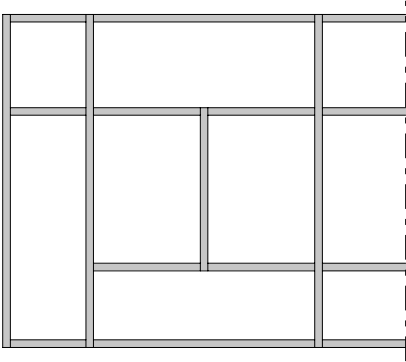

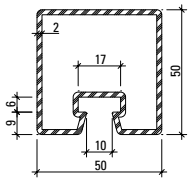

76.694
76.694 Z

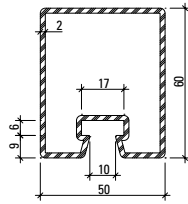

76.671
76.671 Z

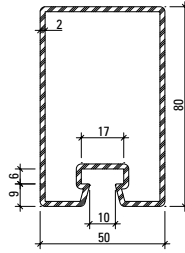

76.696
76.696 Z

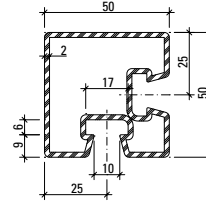

76.094

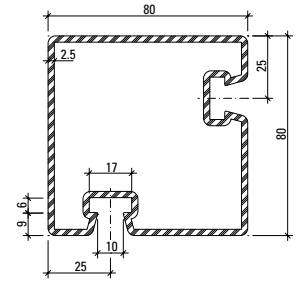

76.096

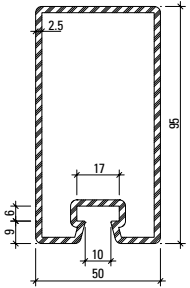

76.697
76.697 Z

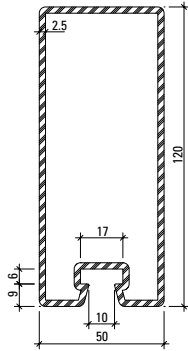

76.679
76.679 Z

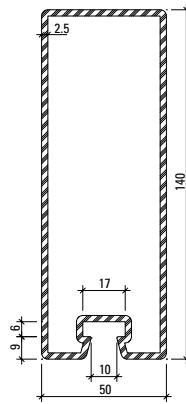

76.666
76.666 Z

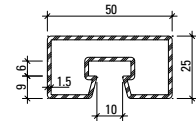

76.682

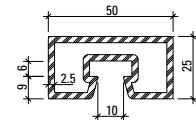

76.680

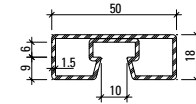

76.692

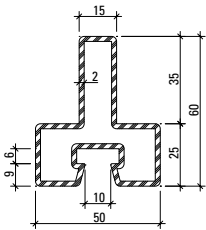

76.114

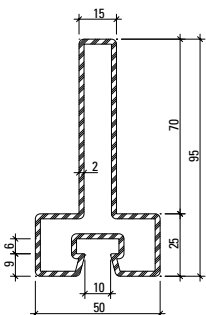

76.115

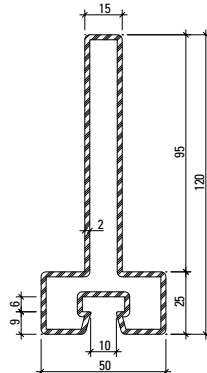

76.116

Profil-Nr.	G kg/m	F cm ²	I _x cm ⁴	W _x cm ³	I _y cm ⁴	W _y cm ³	U m ² /m	L mm
76.094	4,090	5,2	15,2	5,8	15,2	5,8	0,280	6000
76.096	7,437	9,5	83,8	20,5	83,8	20,5	0,391	6000
76.666	7,910	10,1	241,3	32,3	43,7	17,5	0,412	6500
76.671	3,860	4,9	23,3	7,2	17,3	6,9	0,260	6500
76.679	7,120	9,1	162,2	25,2	37,9	15,2	0,373	6500
76.680	3,390	4,3	3,2	2,4	11,1	4,4	0,182	6100
76.682	2,120	2,7	2,2	1,7	7,2	2,9	0,190	6000
76.692	1,900	2,5	0,9	1,0	5,9	2,4	0,176	6000
76.694	3,500	4,5	14,7	5,6	15,0	6,0	0,240	6500
76.696	4,450	5,7	47,6	11,1	21,9	8,8	0,300	6500
76.697	6,100	7,9	90,2	17,6	31,0	12,4	0,330	6500
76.114	3,820	4,9	15,4	4,1	9,8	3,9	0,251	6000
76.115	4,920	6,3	54,8	9,3	10,4	4,2	0,321	6000
76.116	5,710	7,3	105,0	14,3	10,8	4,3	0,371	6000

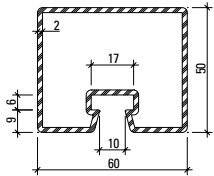

76.695
76.695 Z

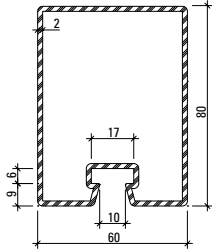

76.678
76.678 Z

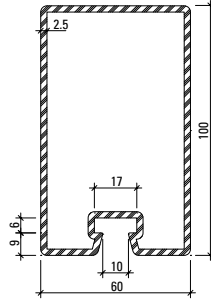

76.684
76.684 Z

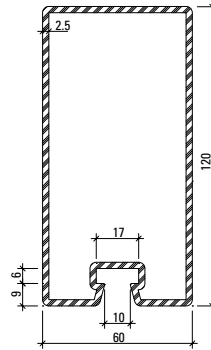

76.698
76.698 Z

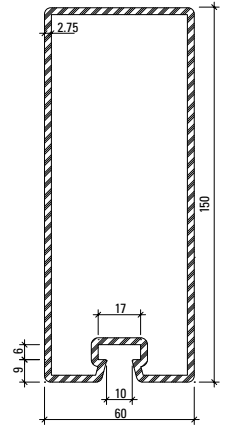

76.667
76.667 Z

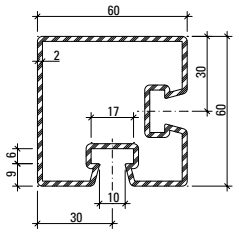

76.095

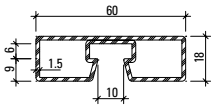

76.693

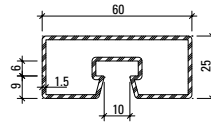

76.683

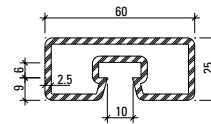

76.681

Artikelbibliothek
 Bibliothèque des articles
 Article library

DXF **DWG**

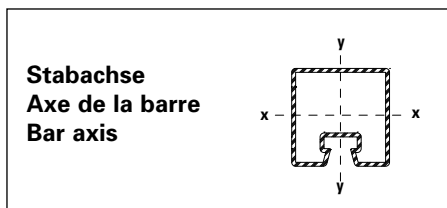

Profil-Nr.	G kg/m	F cm ²	I _x cm ⁴	W _x cm ³	I _y cm ⁴	W _y cm ³	U m ² /m	L mm
76.095	4,750	6,1	27,2	8,6	27,2	8,6	0,311	6000
76.667	9,530	12,1	342,8	43,0	75,1	25,0	0,452	6500
76.678	4,800	6,1	53,9	12,6	32,8	11,0	0,320	6500
76.681	3,790	4,8	3,8	2,9	17,3	5,8	0,202	6100
76.683	2,360	3,0	2,6	2,0	11,1	3,7	0,210	6000
76.684	6,730	8,6	114,1	21,3	48,3	16,1	0,352	6500
76.693	2,140	2,8	1,3	1,3	9,3	3,1	0,196	6000
76.695	3,800	4,9	17,2	6,5	22,9	7,6	0,260	6500
76.698	7,500	9,7	179,6	28,0	56,6	18,9	0,400	6500

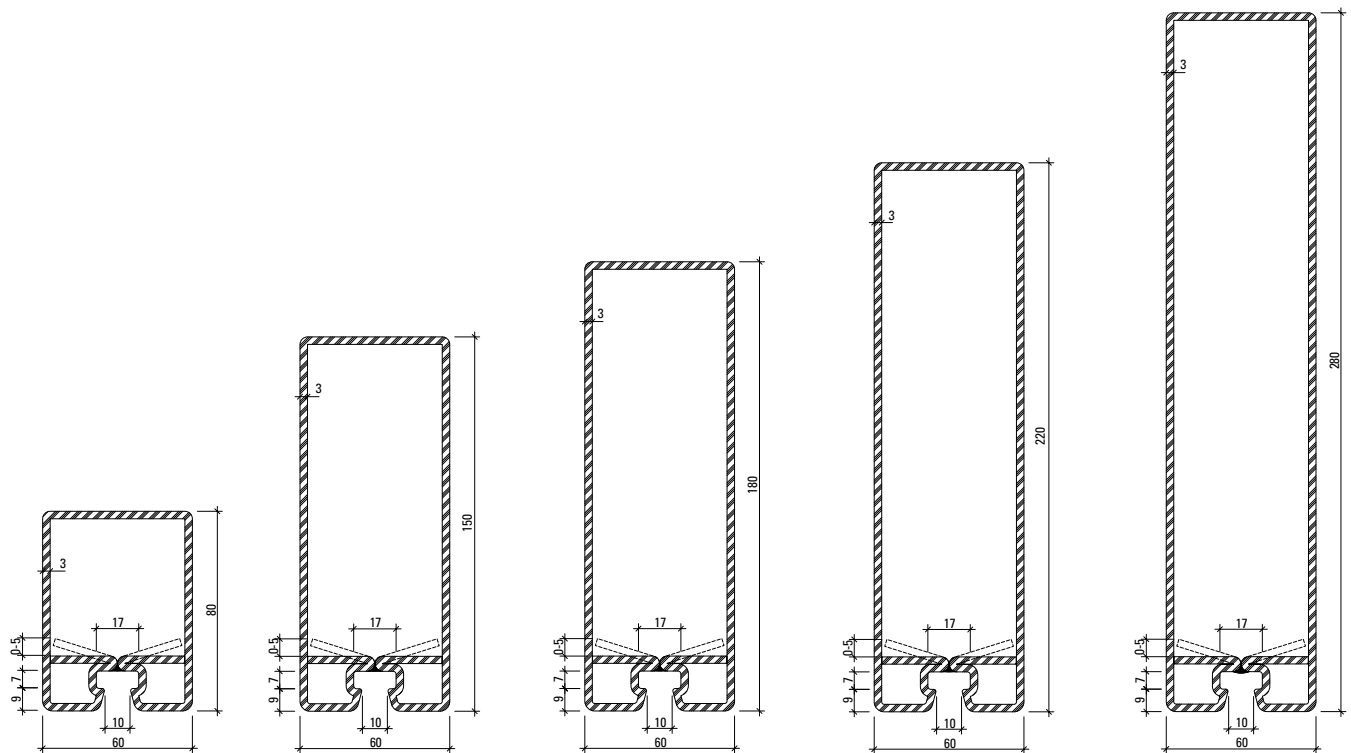

76.143 Z

76.144 Z

76.140 Z

76.141 Z

76.142 Z

Aufgrund von Fertigungstoleranzen kann die Lage des Rückbogens von 0 bis 5 mm variieren.

En raison des tolérances de fabrication, la position du segment coudé peut varier de 0 à 5 mm.

Due to fabrication tolerances, the position of the rear arch may vary between 0 and 5 mm.

Oberfläche/Werkstoff

Artikel-Nr.

ohne Zusatz = blank

mit Z = bandverzinkter Stahl

Surface/Matériau

No. d'article

sans supplément = brut

avec Z = bandes d'acier zinguées

Surface/Material

Part no.

without addition = bright

with Z = galvanised strip

Artikelbibliothek
 Bibliothèque des articles
 Article library

DXF **DWG**

Profil-Nr.	G kg/m	F cm ²	I _x cm ⁴	W _x cm ³	I _y cm ⁴	W _y cm ³	U m ² /m	L mm
76.140 Z	12,946	16,47	649,2	64,3	100,0	33,2	0,516	8000
76.141 Z	14.833	18.87	1090,2	89,1	119,1	39,7	0,596	8000
76.142 Z	17,662	22,5	2041,7	132,7	148,4	49,5	0,716	10000
76.143 Z	8.340	10.62	80,4	17,9	50,8	16,9	0,316	6500
76.144 Z	11.630	14.82	406,0	47,9	85,0	28,3	0,456	6500

Schnittpunkte im Massstab 1:1
Coupe de détails à l'échelle 1:1
Section details on scale 1:1

VISS SG-Fassaden
Façades VISS SG
VISS SG façades

VISS SG HI
Pfosten-Detail
Ansichtsbreite 50 mm

VISS SG HI
Détail de la montante
Largeur de face 50 mm

VISS SG HI
Detail of mullion
Width 50 mm

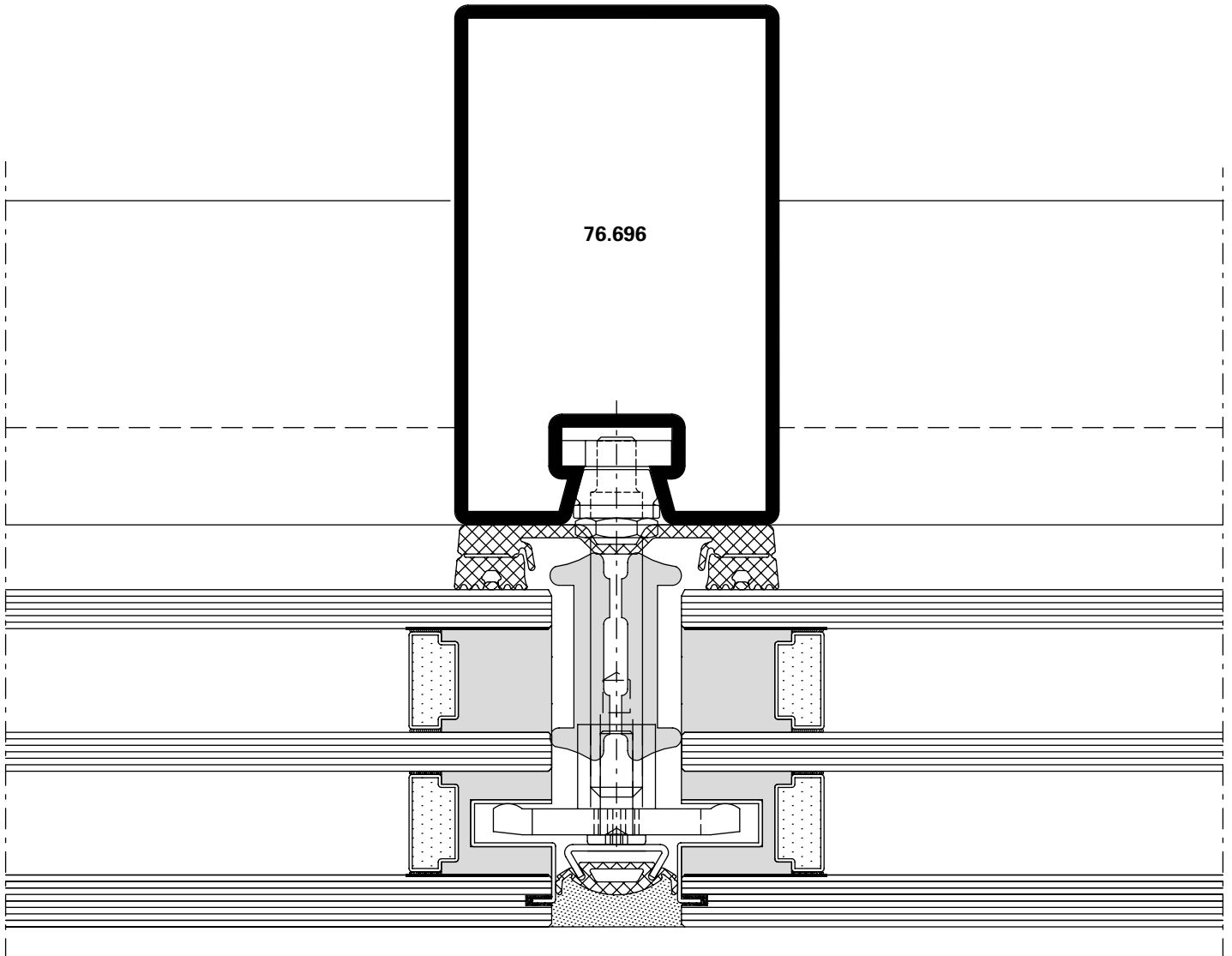

DXF

DWG

D-530-C-002

Schnittpunkte im Massstab 1:1
Coupe de détails à l'échelle 1:1
Section details on scale 1:1

VISS SG-Fassaden
Façades VISS SG
VISS SG façades

VISS SG HI
Riegel-Detail
Ansichtsbreite 50 mm

VISS SG HI
Détail de la traverse
Largeur de face 50 mm

VISS SG HI
Detail of transom
Width 50 mm

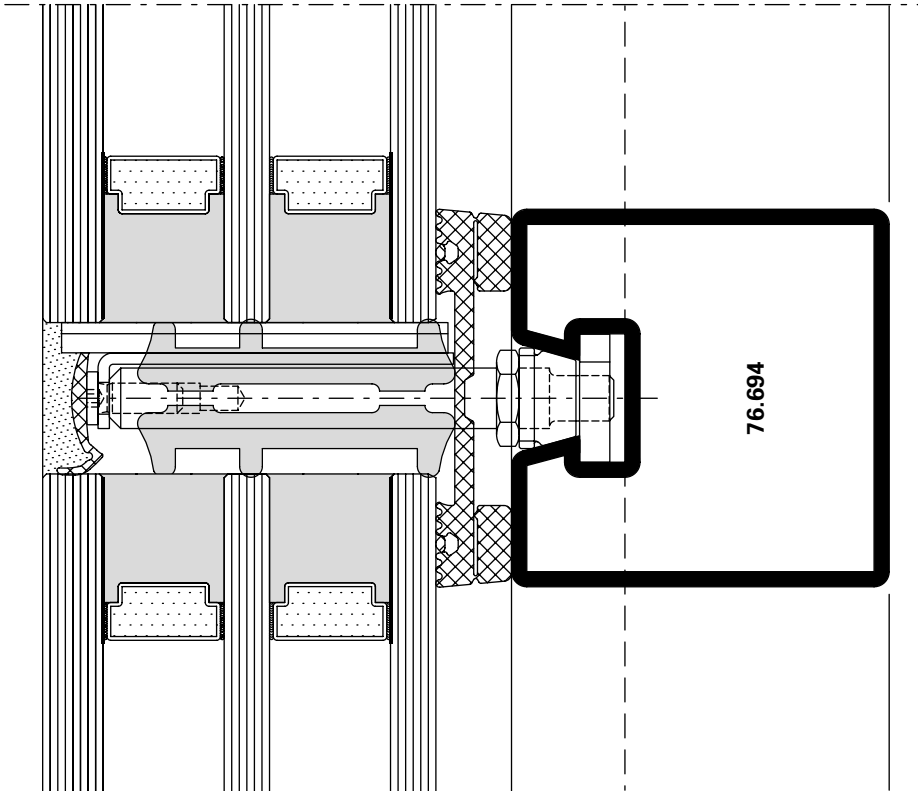

DXF DWG

D-530-C-012

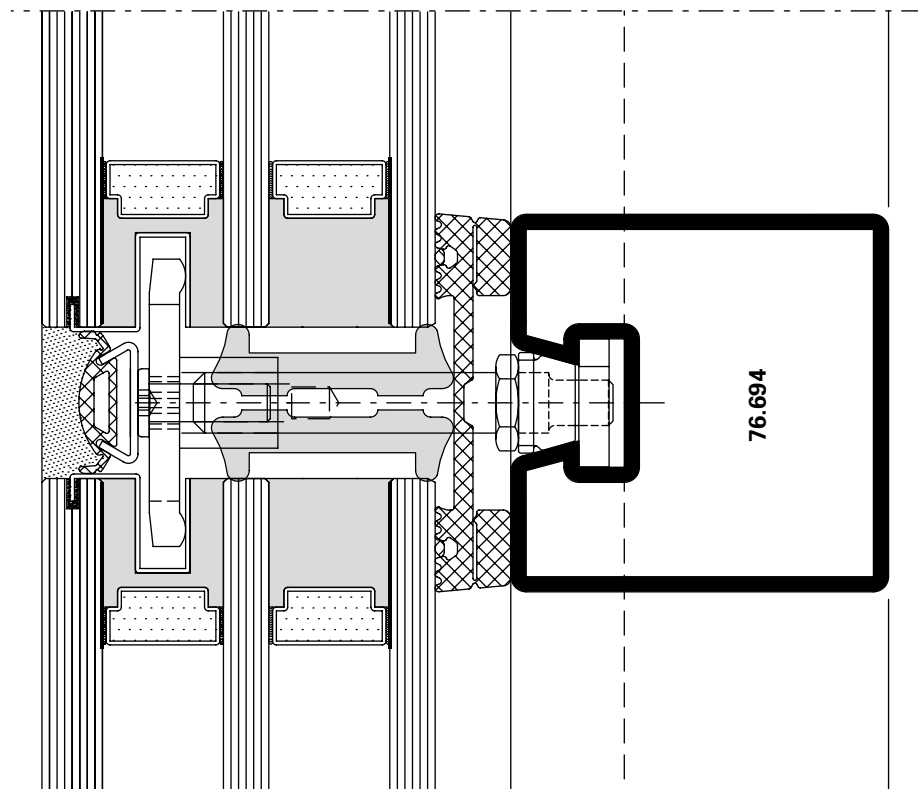

DXF DWG

D-530-C-011

VISS SG
Segmentverglasung
Pfosten-Detail
Ansichtsbreite 50 mm

VISS SG
Vitrage segmenté
Détail de la montante
Largeur de face 50 mm

VISS SG
Segmental glazing
Detail of mullion
Width 50 mm

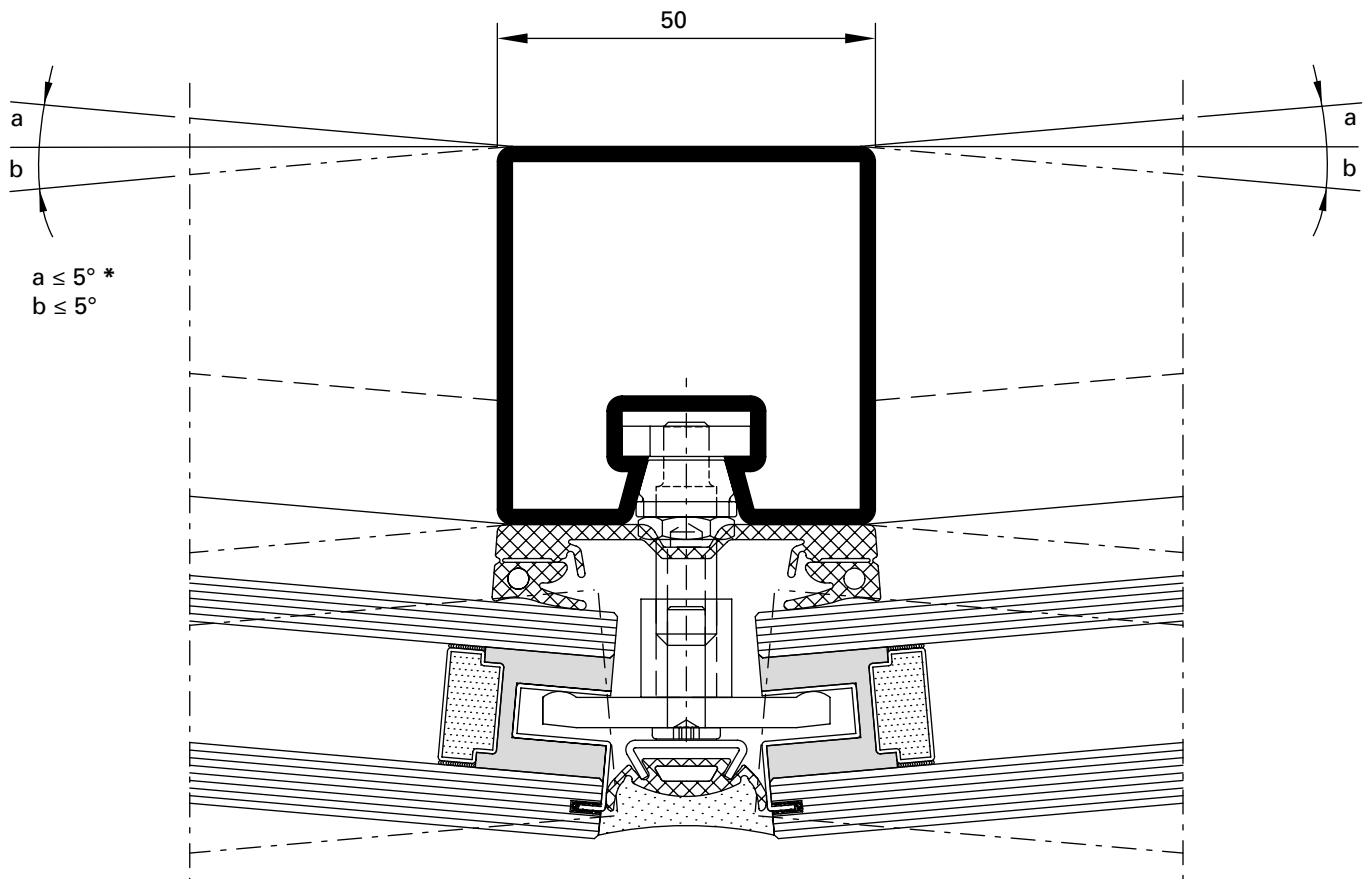

DXF

DWG

D-530-C-009

*** Hinweis**

Dies gilt für Füllelementstärken von 30 - 70 mm bzw. für 2- und 3-fach Verglasungen.

*** Remarque**

Cela est applicable pour les épaisseurs d'élément de remplissage de 30 à 70 mm et pour les vitrages doubles et triples.

*** Note**

This applies to infill unit thicknesses of 30-70 mm and to double and triple glazing.

Schnittpunkte im Massstab 1:1
Coupe de détails à l'échelle 1:1
Section details on scale 1:1

VISS SG-Fassaden
Façades VISS SG
VISS SG façades

VISS SG
Paneelverglasung
Pfosten-Detail
Ansichtsbreite 50 mm

VISS SG
Vitrage panneau
Détail de la montante
Largeur de face 50 mm

VISS SG
Panel glazing
Detail of mullion
Width 50 mm

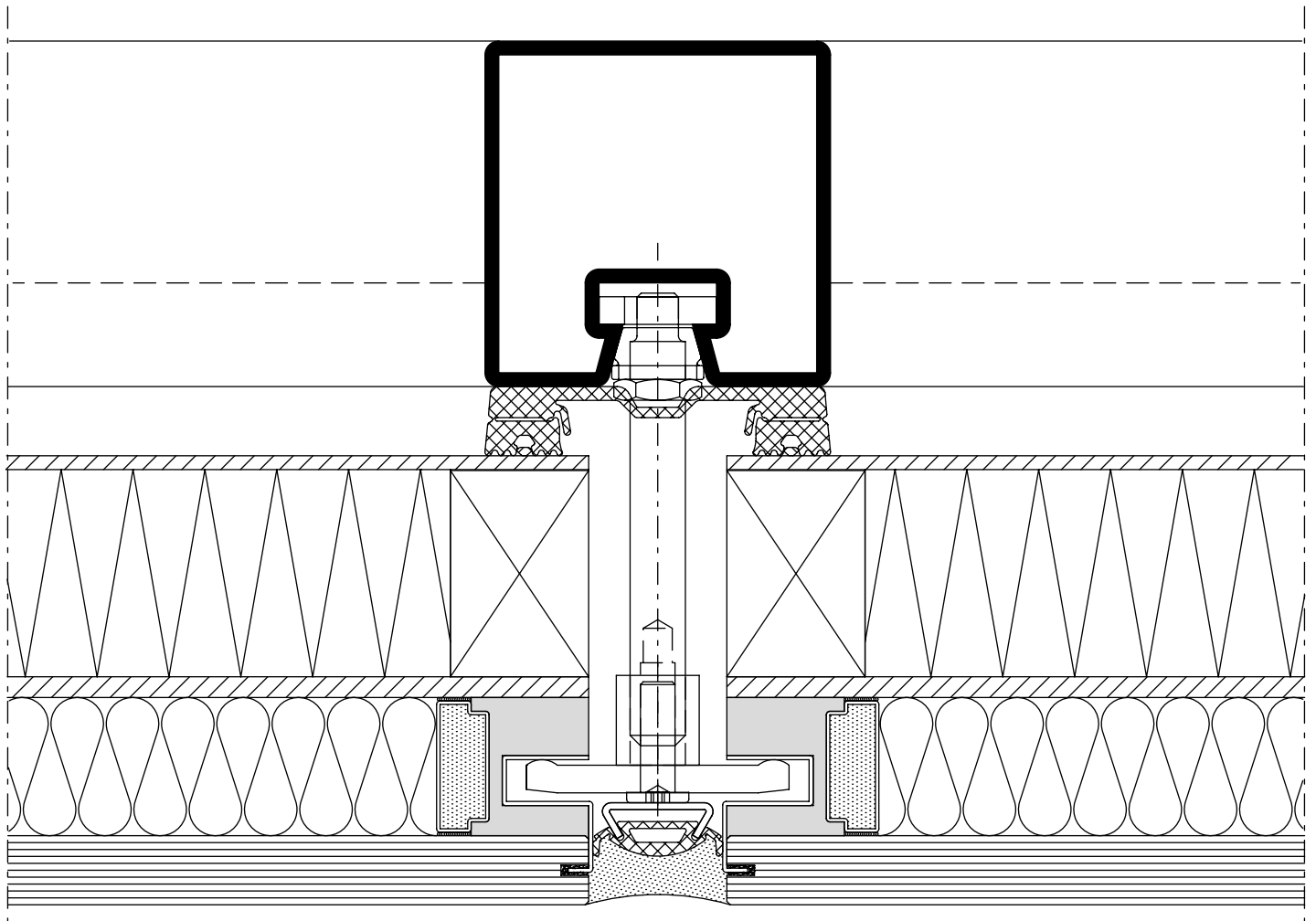

DXF DWG D-530-C-010

Schnittpunkte im Massstab 1:1
Coupe de détails à l'échelle 1:1
Section details on scale 1:1

VISS SG-Fassaden
Façades VISS SG
VISS SG façades

VISS SG HI
Pfoften-Detail
Ansichtsbreite 60 mm

VISS SG HI
Détail de la montante
Largeur de face 60 mm

VISS SG HI
Detail of mullion
Width 60 mm

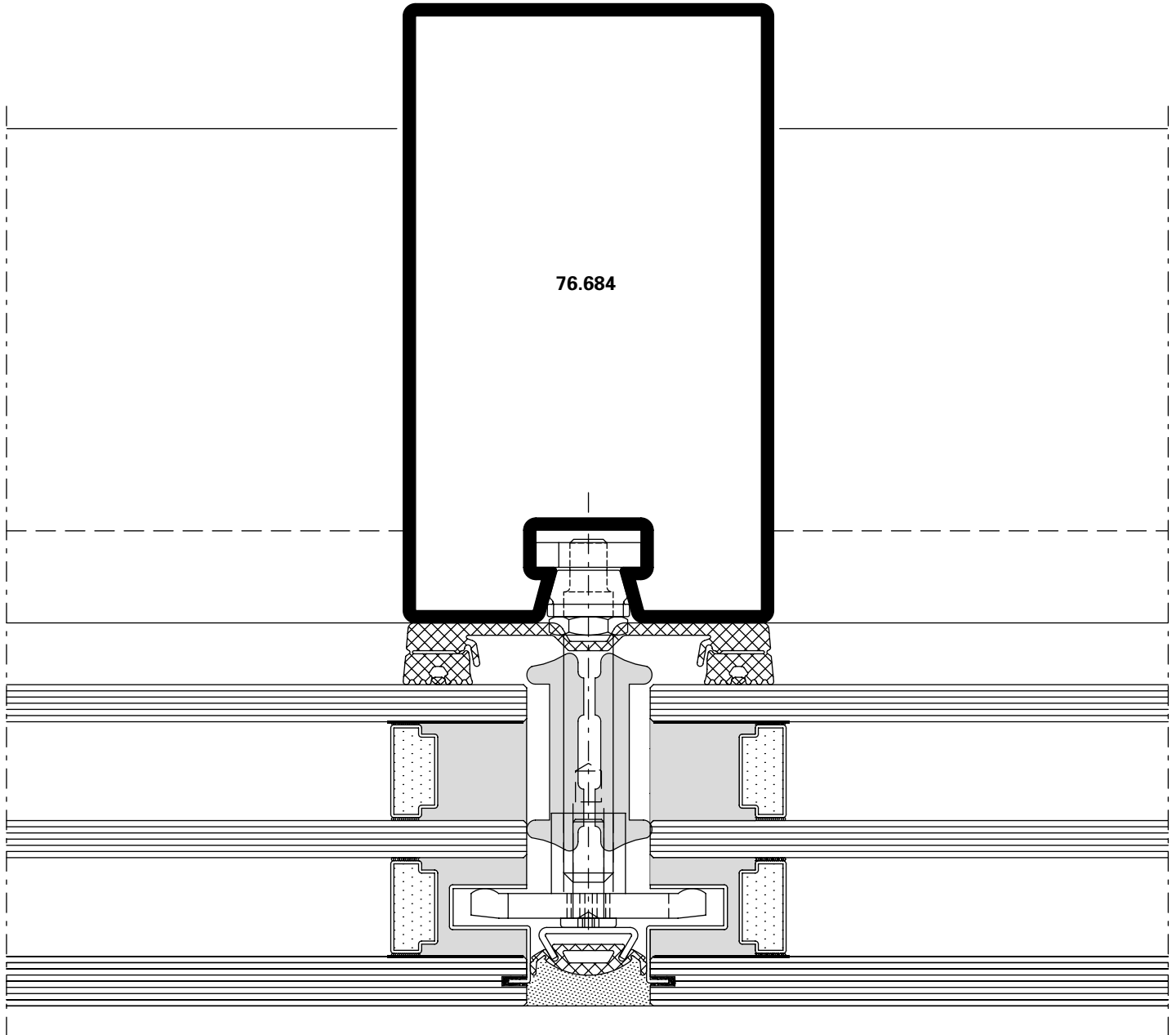

DXF **DWG** D-630-C-002

VISS SG
Segmentverglasung
Pfosten-Detail
Ansichtsbreite 60 mm

VISS SG
Vitrage segmenté
Détail de la montants
Largeur de face 60 mm

VISS SG
Segmental glazing
Detail of mullion
Width 60 mm

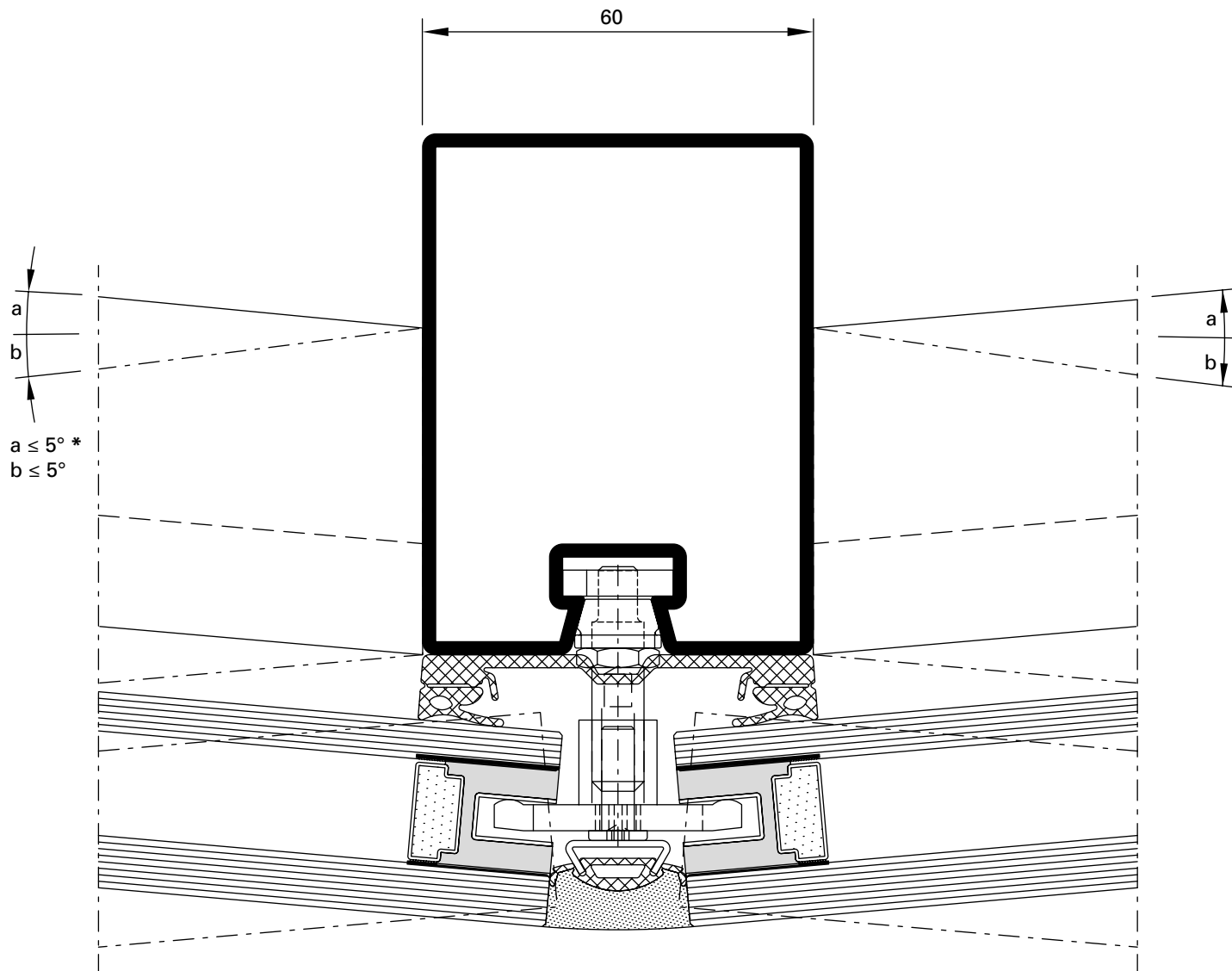

DXF

DWG

D-630-C-008

***Hinweis**

Dies gilt für Füllelementstärken von 30 - 70 mm bzw. für 2- und 3-fach Verglasungen.

*** Remarque**

Cela est applicable pour les épaisseurs d'élément de remplissage de 30 à 70 mm et pour les vitrages doubles et triples.

*** Note**

This applies to infill unit thicknesses of 30-70 mm and to double and triple glazing.

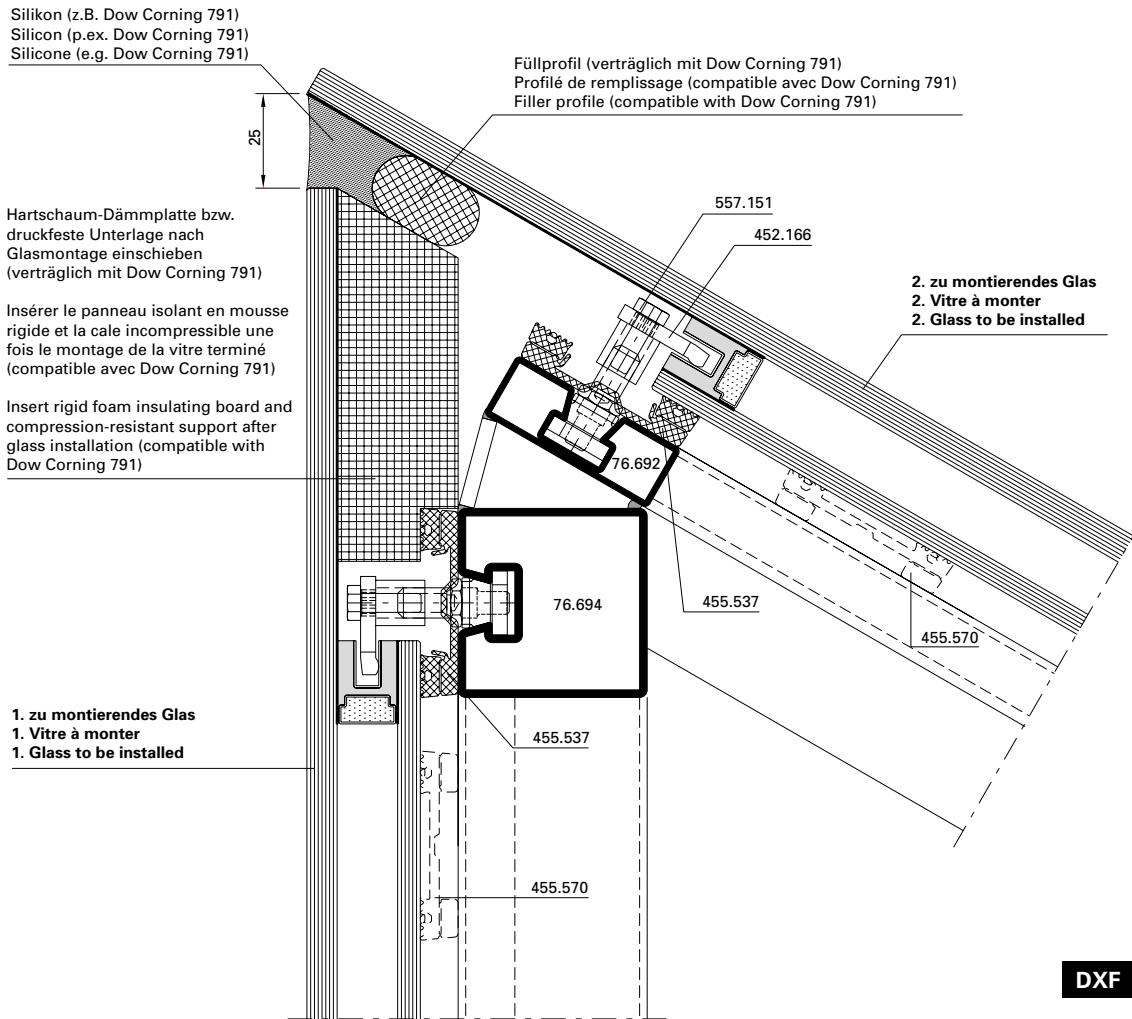

D-530-K-008

Montageablauf

1. Glashalter 452.166 senkrecht vormontieren (vor den Glaselementen).
2. Glaselemente mit kurzer Glasstufe montieren (Anzugsmoment 2 Nm).
3. Mit Haltegabel (durch Metallbauer zu fertigen) Glashalter abdrehen und mit Gabelschlüssel Sechskantschraube vorsichtig eindrehen.
4. Hartschaum-Dämmplatte einschieben
5. Glaselement mit langer Glasstufe montieren (Anzugsmoment 2 Nm) analog Punkt 3.
6. Füllprofil einschieben und Silikonfuge erstellen.

Étapes du montage

1. Prémonter le clip de vitrage 452.166 à la verticale (avant les éléments vitrés).
2. Monter les éléments vitrés avec épaulement de verre court (couple de serrage 2 Nm).
3. Faire tourner le clip de vitrage avec la fourche de maintien (fabriquées par le constructeur métallique) et visser avec précaution avec une clé à fourche à six pans.
4. Insérer le panneau isolant en mousse rigide
5. Monter l'élément vitré à épaulement de verre long (couple de serrage 2 Nm) de manière analogue au point 3.
6. Insérer le profilé de remplissage et réaliser un joint silicone.

Installation sequence

1. Pre-install glazing clip 452.166 vertically (before the glass units).
2. Install glass units with short glass overlap (torque setting 2 Nm).
3. Turn glazing clip with support bracket (to be produced by the metal fabricator) and carefully screw in the hexagon head bolt using the open-ended spanner.
4. Insert rigid foam insulating board.
5. Install glass unit with long glass overlap (torque setting 2 Nm) in the same way as point 3.
6. Insert filler profile and create silicone joint.

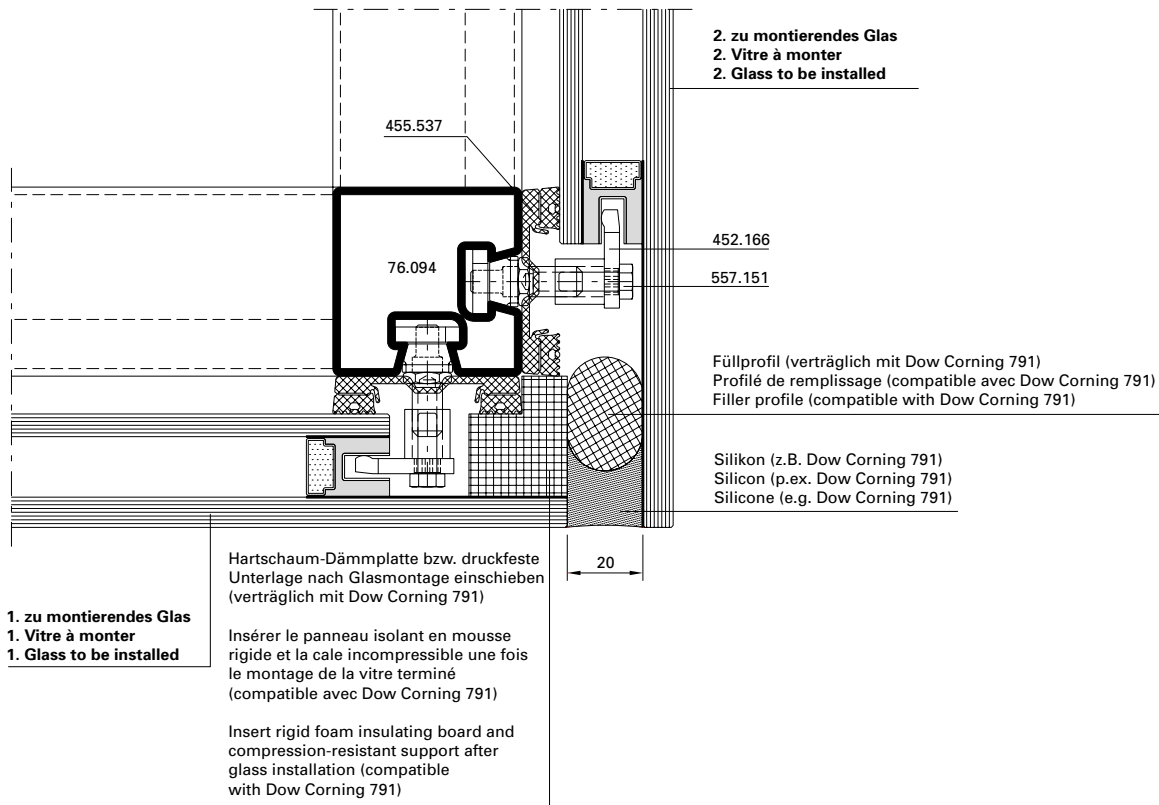

DXF DWG

D-530-K-009

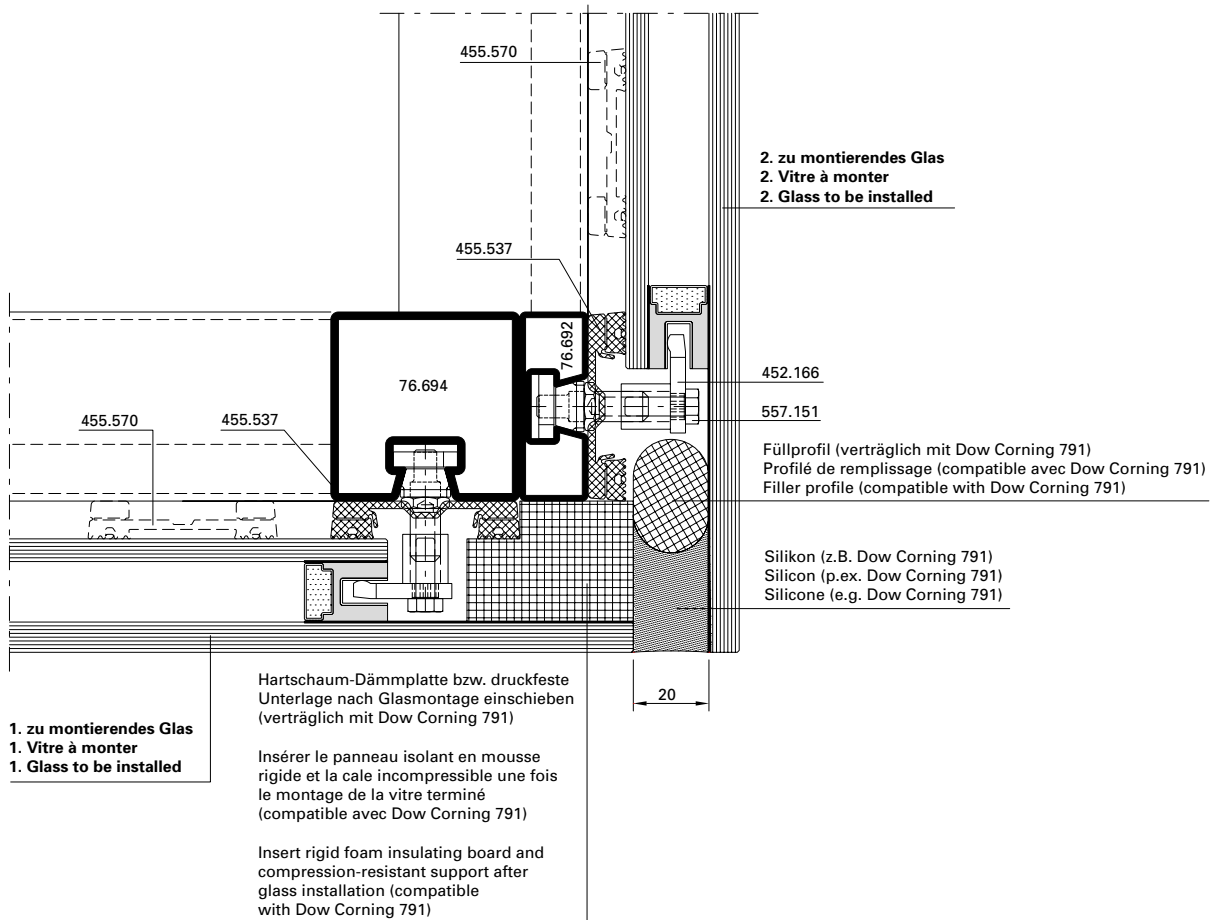

DXF DWG

D-530-K-010

Anschlüsse am Bau im Massstab 1:2
Raccords au mur à l'échelle 1:2
Attachment to structure on scale 1:2

VISS SG-Fassaden
Façades VISS SG
VISS SG façades

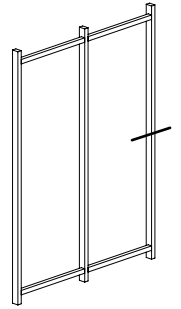
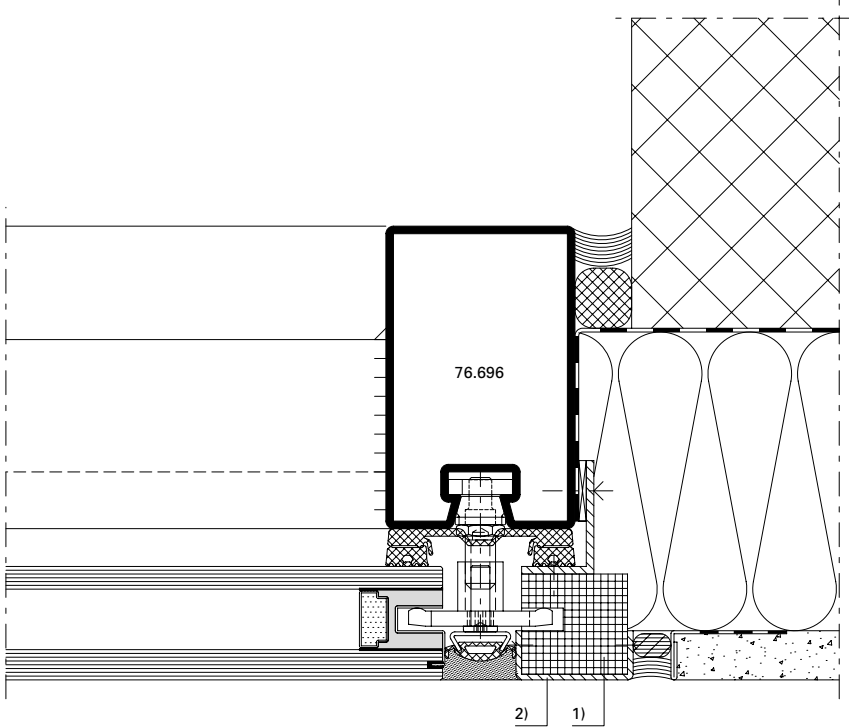

DXF **DWG**

D-530-A-005

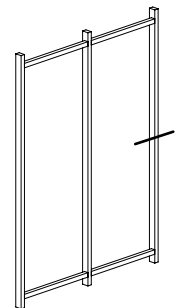
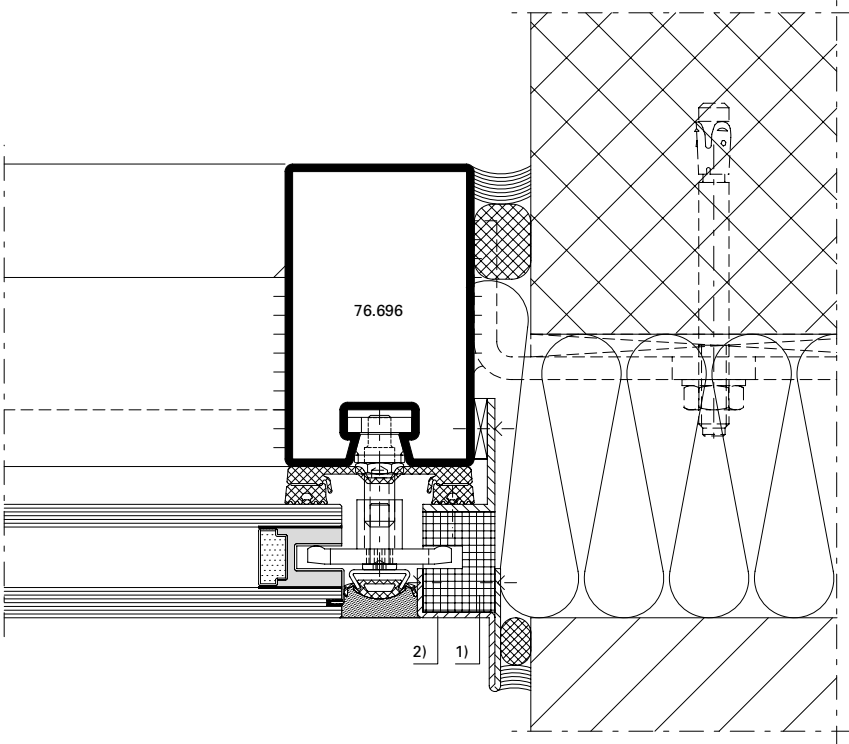

DXF **DWG**

D-530-A-006

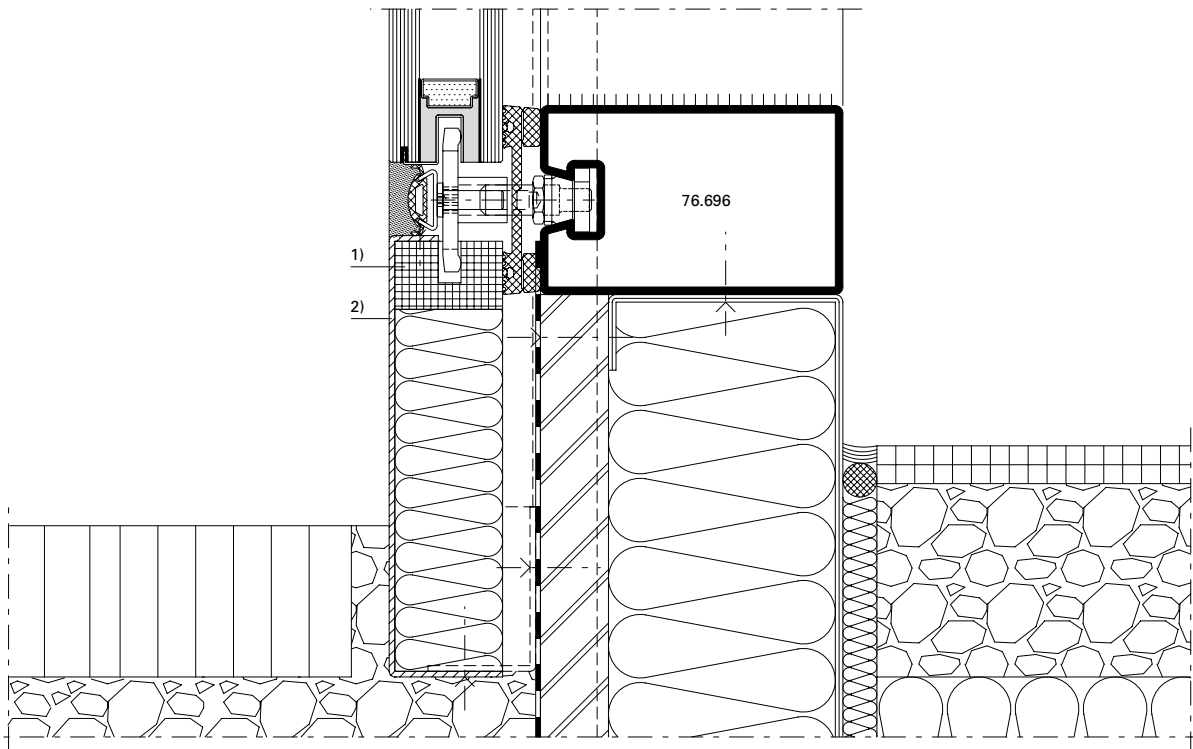

Ausführungshinweis:

- 1) Druckfeste Unterlage
(verträglich mit Dow Corning 791)
- 2) Aluminium eloxiert
(Qualität EURAS A6)

Consigne d'exécution:

- 1) Cale incompressible (compatible
avec Dow Corning 791)
- 2) Aluminium anodisé
(qualité EURAS A6)

Design information:

- 1) Compression-resistant support
(compatible with Dow Corning 791)
- 2) Anodised aluminium
(EURAS quality A6)

System-Hinweise

Remarques concernant les systèmes

System instructions

VISS SG-Fassaden

Façades VISS SG

VISS SG façades

VISS SG HIAnsichtsbreite 50 mm
mit Dämmprofil U_f -Werte nach EN 10077-2**VISS SG HI**Largeur de face 50 mm
avec gaine isolanteValeurs U_f selon EN 10077-2**VISS SG HI**Width 50 mm
with insulating core U_f values according to 10077-2

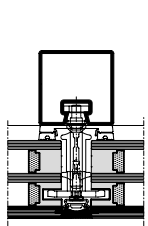
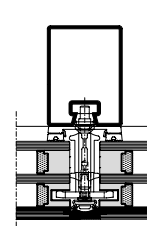
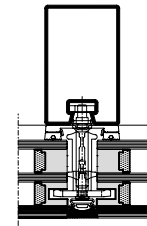
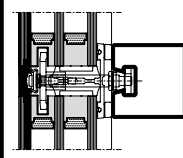
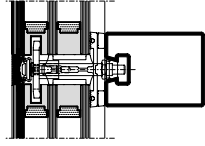
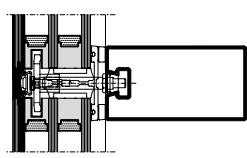
						
Glas Verre Glass	Pfosten 50/50 Montant 50/50 Mullion 50/50	Pfosten 50/95 Montant 50/95 Mullion 50/95	Pfosten 50/140 Montant 50/140 Mullion 50/140	Riegel 50/50 Traverse 50/50 Transom 50/50	Riegel 50/95 Traverse 50/95 Transom 50/95	Riegel 50/140 Traverse 50/140 Transom 50/140
50 mm	0,75 W/m²K	0,76 W/m²K	0,77 W/m²K	0,74 W/m²K	0,75 W/m²K	0,75 W/m²K
60 mm	0,64 W/m²K	0,64 W/m²K	0,65 W/m²K	0,63 W/m²K	0,64 W/m²K	0,64 W/m²K
70 mm	0,58 W/m²K	0,57 W/m²K	0,57 W/m²K	0,56 W/m²K	0,56 W/m²K	0,57 W/m²K

Der Einfluss der Schraubenbefestigung in Höhe von 0.3 W/m²K ist berücksichtigt.

L'influence de la fixation à vis de 0.3 W/m²K est prise en compte.

The 0.3 W/m²K influence of the screw fixing is taken into account.

Unter 40 mm Glasstärke kann das Dämmprofil nicht eingesetzt werden, da sonst keine optimale Glasfalzbelüftung garantiert werden kann.

A moins de 40 mm d'épaisseur de verre, le profilé isolant ne peut être utilisé car il est alors impossible de garantir une aération optimale de la feuillure à verre.

The insulating profile cannot be used with glass thicknesses under 40 mm, as optimum glazing rebate ventilation cannot otherwise be guaranteed.

VISS SG HI
Ansichtsbreite 60 mm
mit Dämmprofil

U_f-Werte nach EN 10077-2

VISS SG HI
Largeur de face 60 mm
avec gaine isolante

Valeurs U_f selon EN 10077-2

VISS SG HI
Width 60 mm
with insulating core

U_f values according to 10077-2

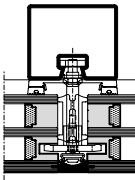
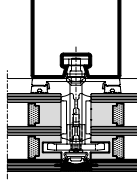
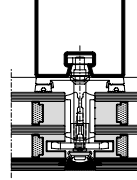
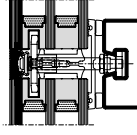
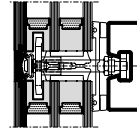
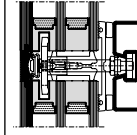
						
Glas Verre Glass	Pfosten 60/50 Montant 60/50 Mullion 60/50	Pfosten 60/100 Montant 60/100 Mullion 60/100	Pfosten 60/150 Montant 60/150 Mullion 60/150	Riegel 60/50 Traverse 60/50 Transom 60/50	Riegel 60/100 Traverse 60/100 Transom 60/100	Riegel 60/150 Traverse 60/150 Transom 60/150
50 mm	0,72 W/m²K	0,73 W/m²K	0,73 W/m²K	0,71 W/m²K	0,72 W/m²K	0,72 W/m²K
60 mm	0,61 W/m²K	0,62 W/m²K	0,62 W/m²K	0,60 W/m²K	0,61 W/m²K	0,61 W/m²K
70 mm	0,56 W/m²K	0,60 W/m²K	0,60 W/m²K	0,50 W/m²K	0,50 W/m²K	0,50 W/m²K

Glas Verre Glass	76.140 Pfosten 60/180 Montant 60/180 Mullion 60/180	76.141 Pfosten 60/220 Montant 60/220 Mullion 60/220	76.142 Pfosten 60/280 Montant 60/280 Mullion 60/280	76.140 Riegel 60/180 Traverse 60/180 Transom 60/180	76.141 Riegel 60/220 Traverse 60/220 Transom 60/220	76.142 Riegel 60/280 Traverse 60/280 Transom 60/280
50 mm	0,73 W/m²K	0,74 W/m²K	0,74 W/m²K	0,72 W/m²K	0,73 W/m²K	0,73 W/m²K
60 mm	0,62 W/m²K	0,62 W/m²K	0,62 W/m²K	0,61 W/m²K	0,61 W/m²K	0,61 W/m²K
70 mm	0,60 W/m²K	0,60 W/m²K	0,60 W/m²K	0,50 W/m²K	0,50 W/m²K	0,50 W/m²K

**Der Einfluss der Schrauben-
befestigung in Höhe von 0.3 W/m²K
ist berücksichtigt.**

Unter 40 mm Glasstärke kann das
Dämmprofil nicht eingesetzt werden,
da sonst keine optimale Glasfalz-
belüftung garantiert werden kann.

**L'influence de la fixation à vis de
0.3 W/m²K est prise en compte.**

A moins de 40 mm d'épaisseur de
verre, le profilé isolant ne peut être
utilisé car il est alors impossible de
garantir une aération optimale de la
feuillure à verre.

**The 0.3 W/m²K influence of the
screw fixing is taken into account.**

The insulating profile cannot be used
with glass thicknesses under 40 mm,
as optimum glazing rebate ventilation
cannot otherwise be guaranteed.

System-Hinweise

Remarques concernant les systèmes

System instructions

VISS SG-Fassaden

Façades VISS SG

VISS SG façades

VISS SG

Ansichtsbreite 50 mm

U_f-Werte nach EN 10077-2**VISS SG**

Largeur de face 50 mm

Valeurs U_f selon EN 10077-2**VISS SG**

Width 50 mm

U_f values according to 10077-2

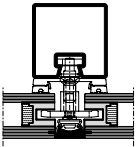
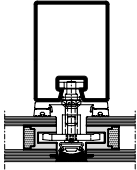
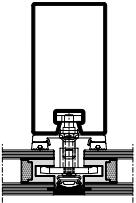
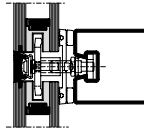
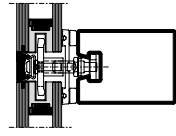
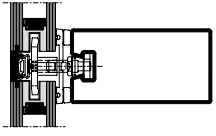
						
Glas Verre Glass	Pfosten 50/50 Montant 50/50 Mullion 50/50	Pfosten 50/95 Montant 50/95 Mullion 50/95	Pfosten 50/140 Montant 50/140 Mullion 50/140	Riegel 50/50 Traverse 50/50 Transom 50/50	Riegel 50/95 Traverse 50/95 Transom 50/95	Riegel 50/140 Traverse 50/140 Transom 50/140
30 mm	1,6 W/m²K	1,6 W/m²K	1,6 W/m²K	1,4 W/m²K	1,4 W/m²K	1,4 W/m²K
40 mm	1,4 W/m²K	1,4 W/m²K	1,4 W/m²K	1,2 W/m²K	1,3 W/m²K	1,3 W/m²K
50 mm	1,3 W/m²K	1,3 W/m²K	1,3 W/m²K	1,1 W/m²K	1,2 W/m²K	1,2 W/m²K
60 mm	1,3 W/m²K	1,3 W/m²K	1,3 W/m²K	1,1 W/m²K	1,1 W/m²K	1,1 W/m²K
70 mm	1,2 W/m²K	1,2 W/m²K	1,2 W/m²K	1,0 W/m²K	1,1 W/m²K	1,1 W/m²K

Der Einfluss der Schraubenbefestigung in Höhe von 0.3 W/m²K ist berücksichtigt.

L'influence de la fixation à vis de 0.3 W/m²K est prise en compte.

The 0.3 W/m²K influence of the screw fixing is taken into account.

VISS SG
Ansichtsbreite 60 mm
U_f-Werte nach EN 10077-2

VISS SG
Largeur de face 60 mm
Valeurs U_f selon EN 10077-2

VISS SG
Width 60 mm
U_f values according to 10077-2

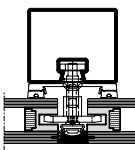
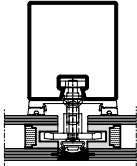
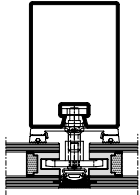
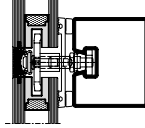
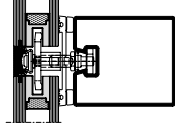
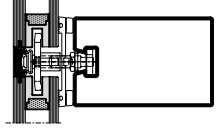
						
Glas Verre Glass	Pfosten 60/50 Montant 60/50 Mullion 60/50	Pfosten 60/100 Montant 60/100 Mullion 60/100	Pfosten 60/150 Montant 60/150 Mullion 60/150	Riegel 60/50 Traverse 60/50 Transom 60/50	Riegel 60/100 Traverse 60/100 Transom 60/100	Riegel 60/150 Traverse 60/150 Transom 60/150
30 mm	1,4 W/m²K	1,5 W/m²K	1,5 W/m²K	1,3 W/m²K	1,3 W/m²K	1,3 W/m²K
40 mm	1,3 W/m²K	1,3 W/m²K	1,3 W/m²K	1,1 W/m²K	1,1 W/m²K	1,2 W/m²K
50 mm	1,2 W/m²K	1,2 W/m²K	1,2 W/m²K	1,0 W/m²K	1,0 W/m²K	1,1 W/m²K
60 mm	1,1 W/m²K	1,1 W/m²K	1,1 W/m²K	0,96 W/m²K	0,97 W/m²K	0,98 W/m²K
70 mm	1,0 W/m²K	1,0 W/m²K	1,1 W/m²K	0,90 W/m²K	0,90 W/m²K	0,90 W/m²K

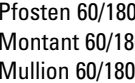
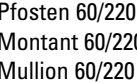
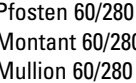
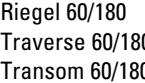
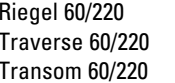
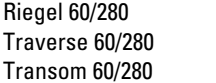
	76.140 	76.141 	76.142 	76.140 	76.141 	76.142 
Glas Verre Glass	Pfosten 60/180 Montant 60/180 Mullion 60/180	Pfosten 60/220 Montant 60/220 Mullion 60/220	Pfosten 60/280 Montant 60/280 Mullion 60/280	Riegel 60/180 Traverse 60/180 Transom 60/180	Riegel 60/220 Traverse 60/220 Transom 60/220	Riegel 60/280 Traverse 60/280 Transom 60/280
50 mm	1,2 W/m²K	1,2 W/m²K	1,2 W/m²K	1,1 W/m²K	1,1 W/m²K	1,1 W/m²K
60 mm	1,1 W/m²K	1,1 W/m²K	1,1 W/m²K	0,98 W/m²K	0,98 W/m²K	0,98 W/m²K
70 mm	1,1 W/m²K	1,1 W/m²K	1,1 W/m²K	0,90 W/m²K	0,90 W/m²K	0,90 W/m²K

**Der Einfluss der Schrauben-
befestigung in Höhe von 0.3 W/m²K
ist berücksichtigt.**

**L'influence de la fixation à vis de
0.3 W/m²K est prise en compte.**

**The 0.3 W/m²K influence of the
screw fixing is taken into account.**

SystemübersichtMaerkmale
Leistungseigenschaften**Sommaire du système**Caractéristiques
Caractéristiques de performance**Summary of system**Characteristics
Performance characteristics**28**

Profilsortiment**Assortiment de profilé****Range of profiles****32**

BeispieleSchnittpunkte
Anschlüsse am Bau**Exemples**Coupe de détails
Raccords au mur**Examples**Section details
Attachment to structure**38**

Alle Ausführungen dieser Dokumentation haben wir sorgfältig und nach bestem Wissen zusammengestellt. Wir können aber keine Verantwortung für die Benützung der vermittelten Vorschläge und Daten übernehmen. Wir behalten uns technische Änderungen ohne Vorankündigung vor.
Aktuelle Version auf www.jansen.com

Nous avons apporté le plus grand soin à l'élaboration de cette documentation. Cependant, nous déclinons toute responsabilité pour l'utilisation faite de nos propositions et de nos données.
Nous nous réservons le droit de procéder à des modifications techniques sans préavis.
Version actuelle sur www.jansen.com

All the information contained in this documentation is given to the best of our knowledge and ability. However, we decline all responsibility for the use made of these suggestions and data.
We reserve the right to effect technical modifications without prior warning.
Current version available at www.jansen.com

Merkmale
Caractéristiques
Characteristics

VISS Semi SG-Fassaden
Façades VISS Semi SG
VISS Semi SG façades

- CE-Kennzeichnung nach EN 13830
- Betonung der horizontalen oder vertikalen Linien
- Erhöht die Transparenz der Fassade
- Glasstösse mit einer Silikonfuge von nur 20 mm
- Ansichtsbreiten 50 und 60 mm
- Zweifach- und Dreifach-Isolierglas Glasstärken bis 30 - 70 mm
- Kombinierbar mit der VISS Fassade sowie VISS Basic
- Einfache Realisierung von Ganzglas-Ecklösungen
- Mechanische Fixierung der Gläser - kein Verkleben notwendig





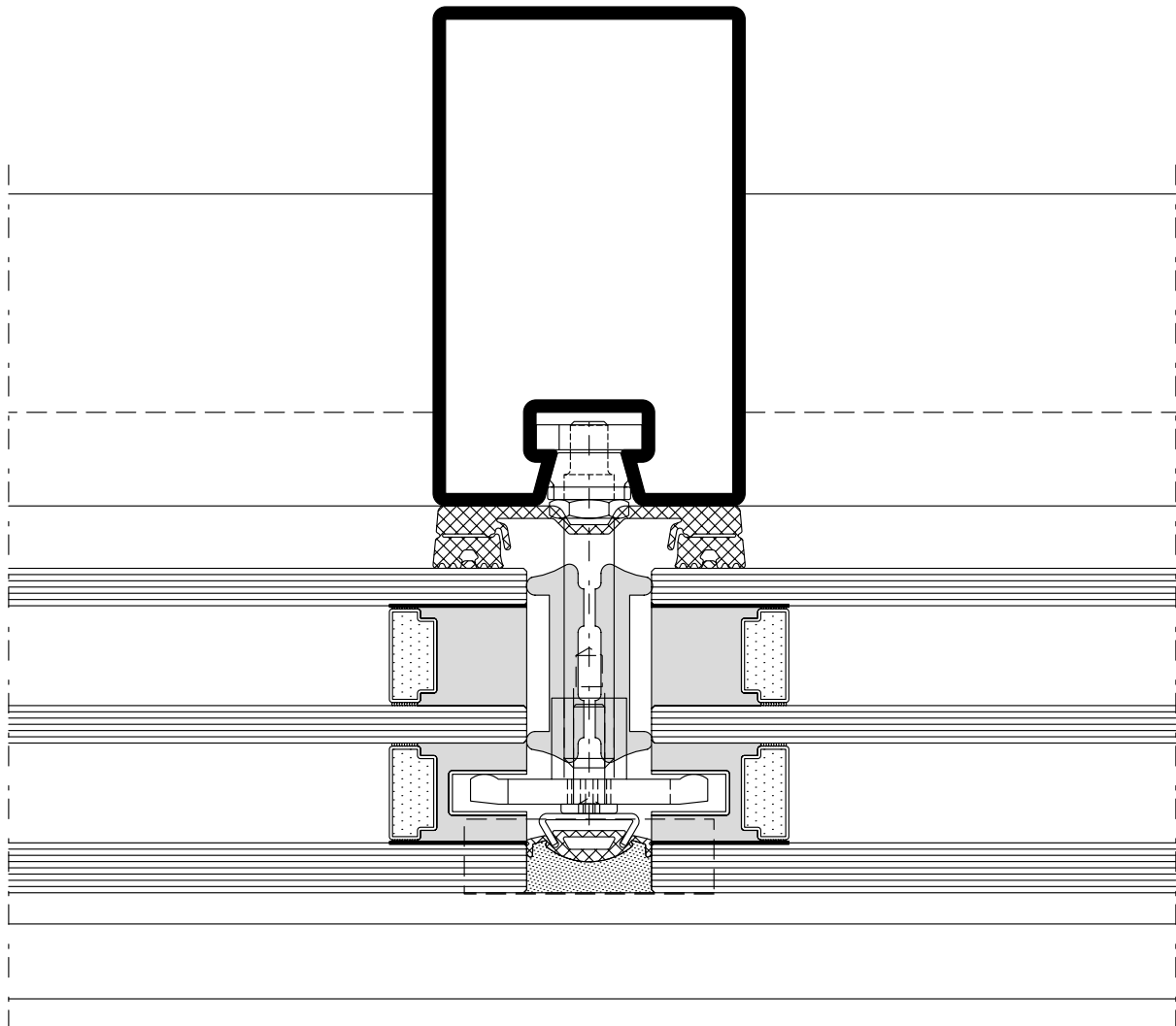

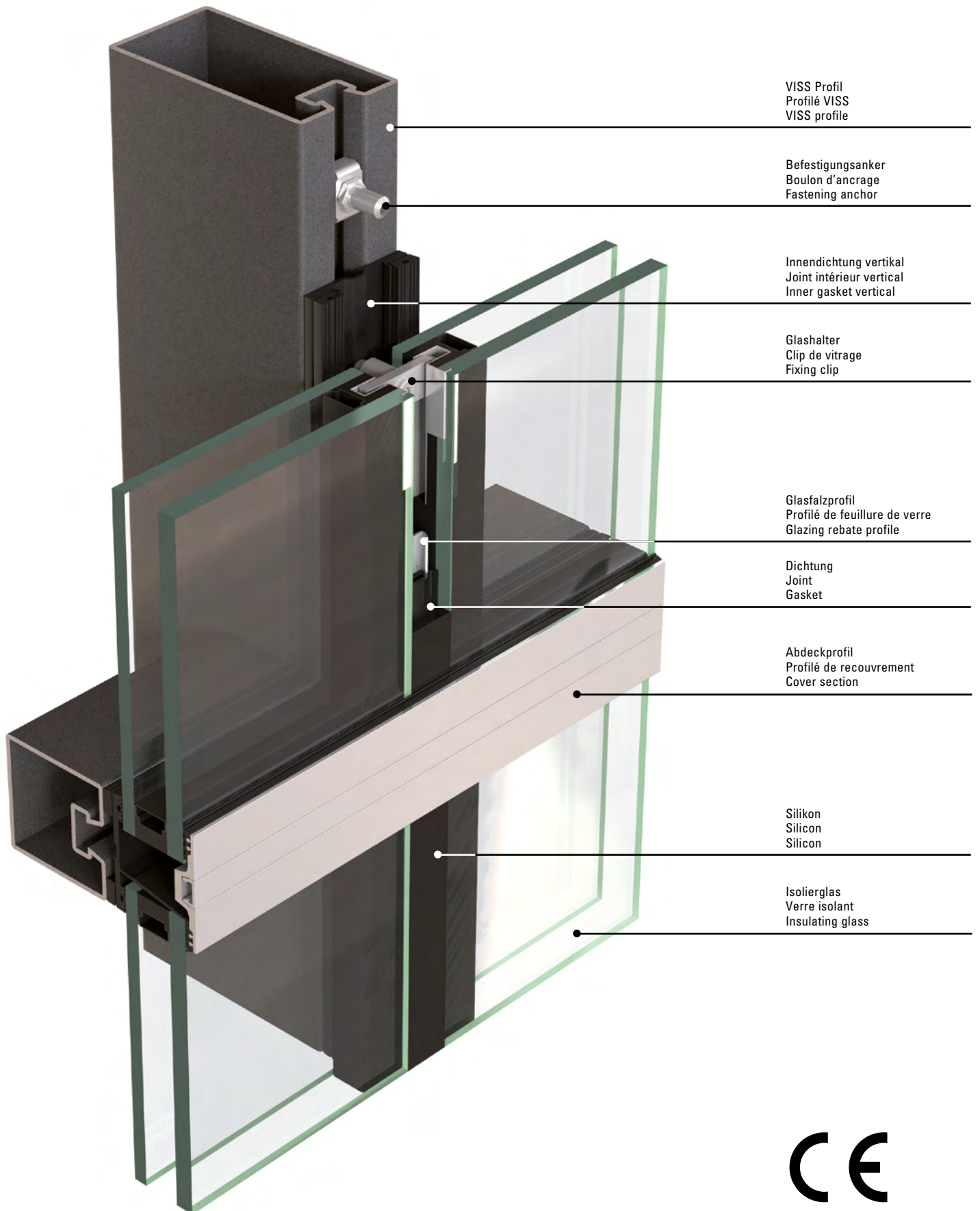
- Marquage CE selon EN 13830
- Accentuation des lignes horizontales ou verticales
- Accroît la transparence de la façade
- Étanchéité grâce à un joint silicone de seulement 20 mm
- Largeurs de face 50 et 60 mm
- Verre isolant double ou triple, épaisseurs de verre jusqu'à 30 à 70 mm
- Combinable avec les façades VISS et VISS Basic
- Réalisation simple d'angles tout verre
- Fixation mécanique des vitres - inutile de coller

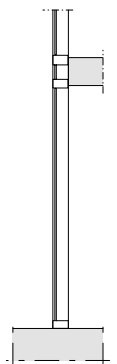
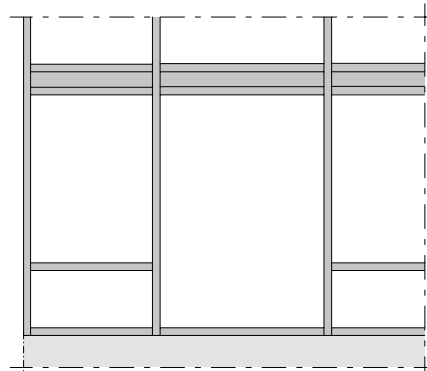
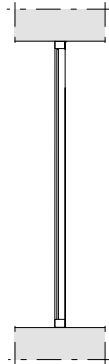
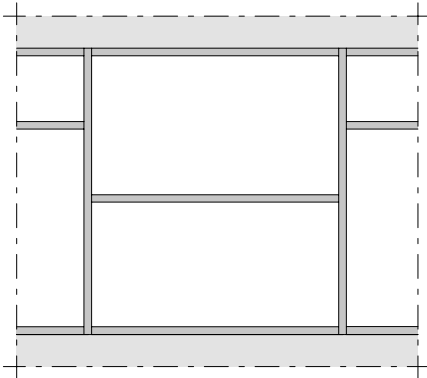
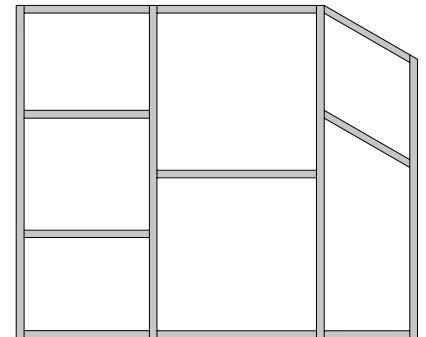
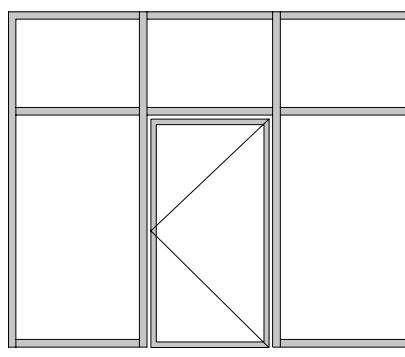
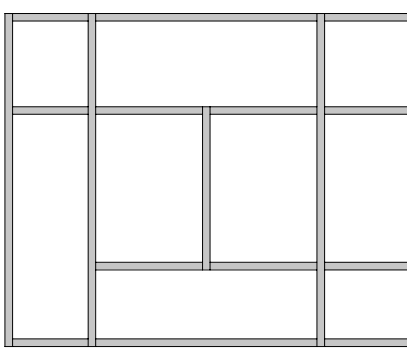
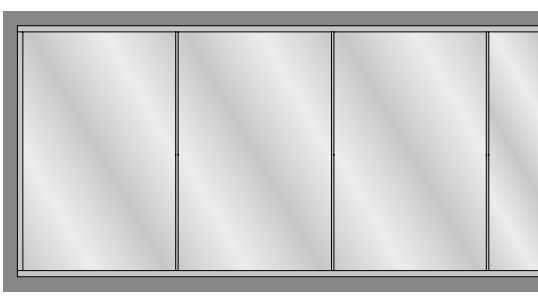
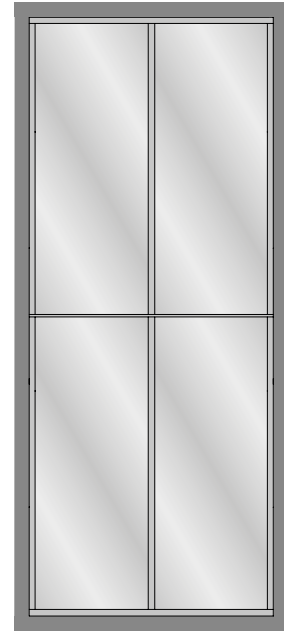
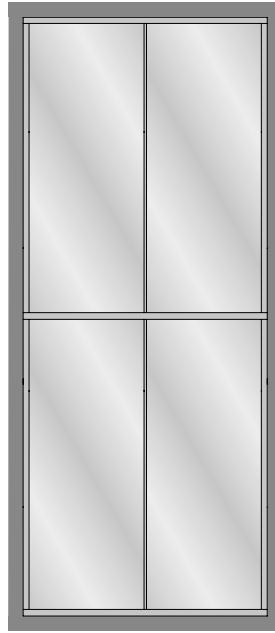
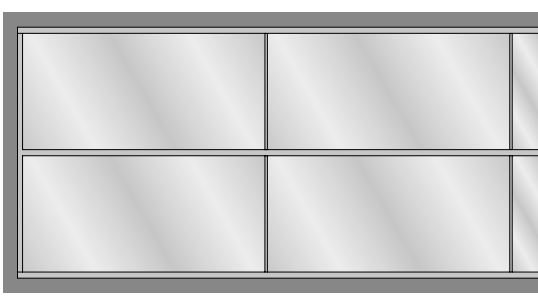
- CE marking in accordance with EN 13830
- Emphasis of horizontal or vertical lines
- Increases the degree of transparency of the façade
- Glass joints with a silicone joint of just 20 mm
- Face widths of 50 and 60 mm
- Double and triple insulating glass thicknesses of up to 30 - 70 mm
- Can be combined with the VISS façade as well as VISS Basic
- Easy implementation of all-glass corner solutions
- Mechanical fixing of the glass - no bonding required







	Prüfungen (Prüfnorm) Essais (Norme d'essai) Tests (Test standard)	Klassifizierungs-Norm Norme de classification Classification standard	Werte Valeurs Values
	Schlagregendichtheit (EN 12155) Etanchéité à la pluie battante (EN 12155) Watertightness (EN 12155)	EN 12154	RE 1200
	Widerstand bei Windlast (EN 12179) Résistance à la pression du vent (EN 12179) Resistance to wind load (EN 12179)	EN 13116	Bemessungslast 2 kN/m ² Charge de calcul 2 kN/m ² Designed load 2 kN/m ²
	Luftdurchlässigkeit (EN 12153) Perméabilité à l'air (EN 12153) Air permeability (EN 12153)	EN 12152	Klasse AE Classe AE Class AE
	Wärmedurchgangskoeffizient (EN 13947) Transmission thermique (EN 13947) Thermal production (EN 13947)	EN ISO 10077-2	ab $U_f > 0.50 \text{ W/m}^2\text{K}$ dès $U_f > 0.50 \text{ W/m}^2\text{K}$ from $U_f > 0.50 \text{ W/m}^2\text{K}$
	Stoßfestigkeit Résistance au chocs Impact strength	EN 14019	Klasse E5 / I5 Classe E5 / I5 Class E5 / I5
	Technische Regeln für die Verwendung von absturz sichernden Verglasungen Règlement technique pour la sécurité anti-chute des vitrages The technical regulations for protecting glazing against falling out	DIN 18008-4	Kategorie A, C2, C3 Catégorie A, C2, C3 Category A, C2, C3

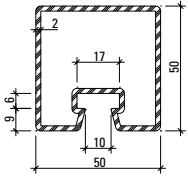

76.694
76.694 Z

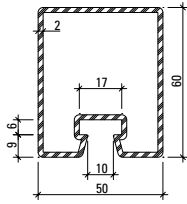

76.671
76.671 Z

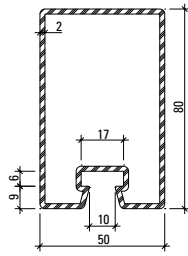

76.696
76.696 Z

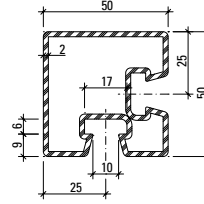

76.094

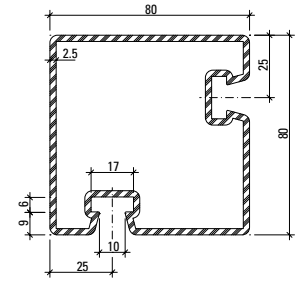

76.096

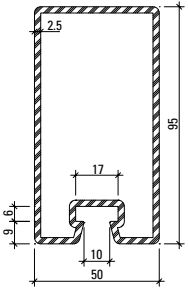

76.697
76.697 Z

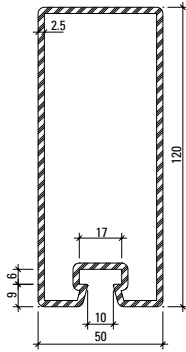

76.679
76.679 Z

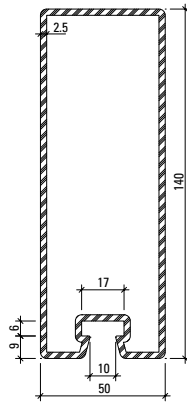

76.666
76.666 Z

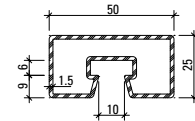

76.682

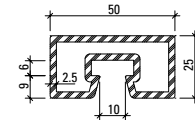

76.680

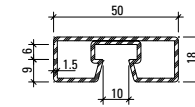

76.692

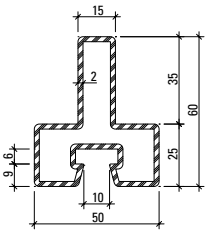

76.114

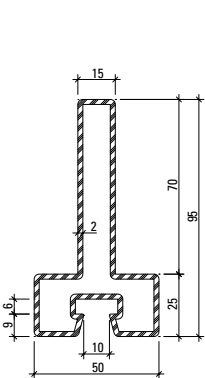

76.115

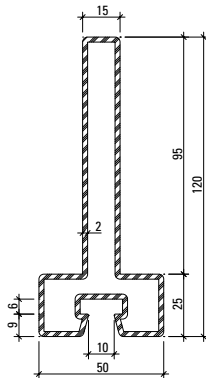

76.116

Profil-Nr.	G kg/m	F cm ²	I _x cm ⁴	W _x cm ³	I _y cm ⁴	W _y cm ³	U m ² /m	L mm
76.094	4,090	5,21	15,2	5,90	15,20	5,90	0,280	6000
76.096	6,000	7,64	68,5	16,79	68,53	16,79	0,391	6000
76.666	7,910	10,10	240,0	32,10	43,50	17,40	0,412	6500
76.671	3,860	4,90	23,20	7,20	17,30	6,90	0,260	6500
76.679	7,120	9,07	162,0	25,20	37,90	15,20	0,373	6500
76.680	3,390	4,32	3,17	2,38	11,08	4,43	0,182	6100
76.682	2,120	2,70	2,34	1,81	7,20	2,90	0,190	6000
76.692	1,900	2,52	0,85	0,81	6,00	2,40	0,176	6000
76.694	3,500	4,50	15,0	5,70	14,80	5,90	0,240	6500
76.696	4,450	5,70	48,4	11,50	21,80	8,70	0,300	6500
76.697	6,100	7,90	92,0	17,90	31,00	12,40	0,330	6500
76.114	3,820	4,87	15,36	4,14	9,79	3,91	0,251	6000
76.115	4,920	6,27	54,76	9,31	10,38	4,15	0,321	6000
76.116	5,710	7,27	105,0	14,31	10,81	4,32	0,371	6000

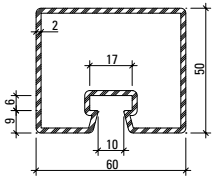

76.695
76.695 Z

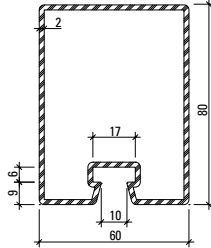

76.678
76.678 Z

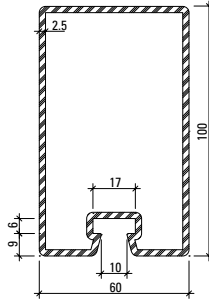

76.684
76.684 Z

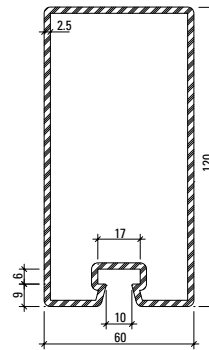

76.698
76.698 Z

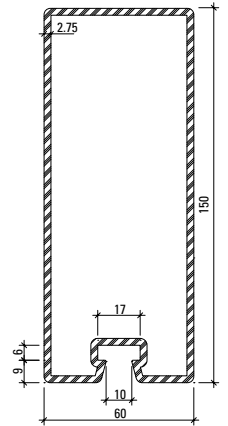

76.667
76.667 Z

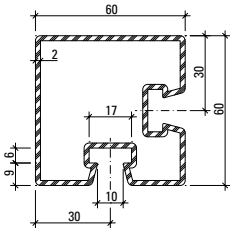

76.095

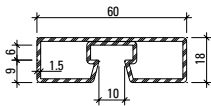

76.693

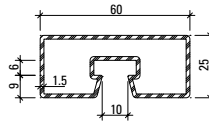

76.683

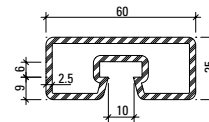

76.681

Artikelbibliothek
 Bibliothèque des articles
 Article library

DXF **DWG**

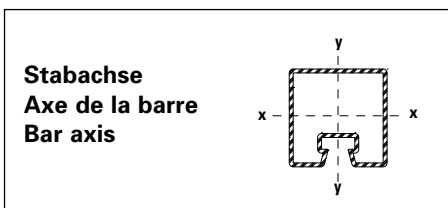

Profil-Nr.	G kg/m	F cm ²	I _x cm ⁴	W _x cm ³	I _y cm ⁴	W _y cm ³	U m ² /m	L mm
76.095	4,750	6,05	27,2	8,56	27,17	8,56	0,311	6000
76.667	9,530	12,10	343,0	43,00	75,10	25,00	0,452	6500
76.678	4,800	6,11	53,9	12,60	33,20	11,10	0,320	6500
76.681	3,790	4,82	3,81	2,89	17,29	5,76	0,202	6100
76.683	2,360	3,00	2,77	2,14	11,20	3,70	0,210	6000
76.684	6,730	8,57	114,0	21,30	48,30	16,10	0,352	6500
76.693	2,140	2,82	1,20	1,10	9,50	3,10	0,196	6000
76.695	3,800	4,90	17,6	6,70	22,80	7,60	0,260	6500
76.698	7,500	9,67	183,0	28,30	55,50	18,50	0,400	6500

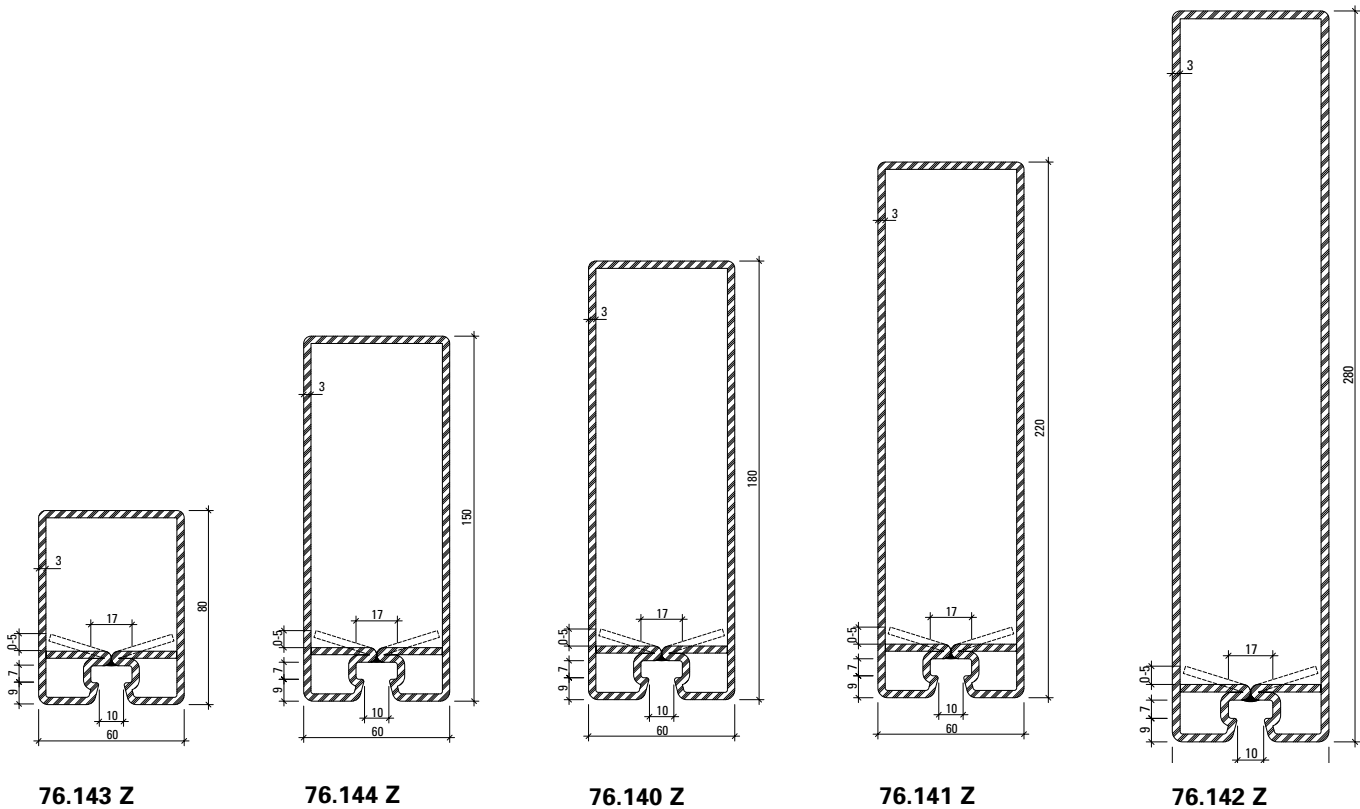

Aufgrund von Fertigungstoleranzen kann die Lage des Rückbogens von 0 bis 5 mm variieren.

En raison des tolérances de fabrication, la position du segment coudé peut varier de 0 à 5 mm.

Due to fabrication tolerances, the position of the rear arch may vary between 0 and 5 mm.

Oberfläche/Werkstoff

Artikel-Nr.

ohne Zusatz = blank

mit Z = bandverzinkter Stahl

Surface/Matériau

No. d'article

sans supplément = brut

avec Z = bande d'acier zinguée

Surface/Material

Part no.

without addition = bright

with Z = strip galvanised steel

Artikelbibliothek
 Bibliothèque des articles
 Article library

DXF **DWG**

Profil-Nr.	G kg/m	F cm ²	I _x cm ⁴	W _x cm ³	I _y cm ⁴	W _y cm ³	U m ² /m	L mm
76.140 Z	12,946	16,47	649,2	64,3	100,0	33,2	0,516	8000
76.141 Z	14.833	18.87	1090,2	89,1	119,1	39,7	0,596	8000
76.142 Z	17,662	22,5	2041,7	132,7	148,4	49,5	0,716	10000
76.143 Z	8.340	10.62	80,4	17,9	50,8	16,9	0,316	6500
76.144 Z	11.630	14.82	406,0	47,9	85,0	28,3	0,456	6500

Deckprofile 50 mm (Massstab 1:3)
Profils de recouvrement 50 mm (échelle 1:3)
Cover sections 50 mm (scale 1:3)

VISS Semi SG-Fassaden
 Façades VISS Semi SG
 VISS Semi SG façades

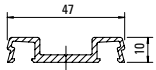

407.800

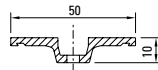

407.821



407.823

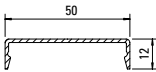

407.860

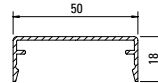

407.861

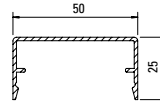

407.862

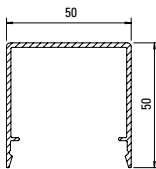

407.863

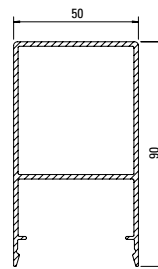

407.864

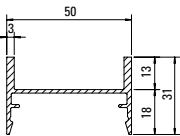

407.900

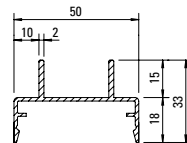

407.911

Werkstoff

Aluminium EN AW 6060 T66 roh, leicht eingeölt

Matériau

Aluminium EN AW 6060 T66 brut, légèrement huilé

Material

Aluminium EN AW 6060 T66 mill finish, slightly oiled

Profil-Nr.	G kg/m	U m ² /m	P m ² /m	L mm
407.800	0,414	0,160		6000
407.821	0,440	0,143	0,067	6000
407.823	0,076	0,043	0,019	6000
407.860	0,266	0,147	0,072	6000

Profil-Nr.	G kg/m	U m ² /m	P m ² /m	L mm
407.861	0,341	0,185	0,084	6000
407.862	0,394	0,213	0,098	6000
407.863	0,660	0,313	0,148	6000
407.864	1,344	0,360	0,228	6000
407.900	0,556	0,240	0,138	6000
407.911	0,510	0,245	0,146	6000

Deckprofile 50 mm (Masstab 1:3)**Profils de recouvrement 50 mm (échelle 1:3)****Cover sections 50 mm (scale 1:3)**

VISS Semi SG-Fassaden

Façades VISS Semi SG

VISS Semi SG façades

Edelstahl-Abdeckprofile
Werkstoff 1.4301 (AISI 304)
 geschliffen, Korn 220/240,
 mit Schutzfolie

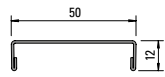
**400.860**

Profilé de recouvrement acier Inox
Qualité 1.4301 (AISI 304)
 meulé, degré 220/240,
 avec feuille de protection

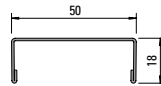
**400.861**

Stainless steel cover sections
Material 1.4301 (AISI 304)
 polished, grain 220/240,
 with protective film

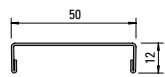

Edelstahl-Abdeckprofile
Werkstoff 1.4401 (AISI 316)
 geschliffen, Korn 220/240,
 mit Schutzfolie

**400.862**

Profilé de recouvrement acier Inox
Qualité 1.4401 (AISI 316)
 meulé, degré 220/240,
 avec feuille de protection

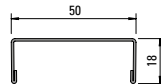
**400.863**

Stainless steel cover sections
Material 1.4401 (AISI 316)
 polished, grain 220/240,
 with protective film



Profil-Nr.	G kg/m	L mm
400.860	0,644	6000
400.861	0,734	6000

Profil-Nr.	G kg/m	L mm
400.862	0,652	6000
400.863	0,744	6000

Artikelbibliothek
 Bibliothèque des articles
 Article library

DXF**DWG**

Deckprofile 60 mm (Massstab 1:3)
Profils de recouvrement 60 mm (échelle 1:3)
Cover sections 60 mm (scale 1:3)

VISS Semi SG-Fassaden
 Façades VISS Semi SG
 VISS Semi SG façades

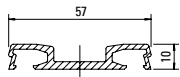

407.802

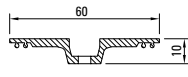

407.822



407.823

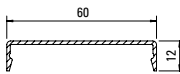

407.865

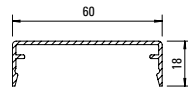

407.866

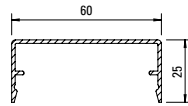

407.867

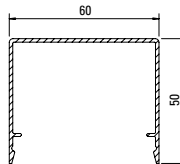

407.868

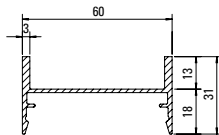

407.901

Werkstoff

Aluminium EN AW 6060 T66 roh, leicht eingeölt

Matériau

Aluminium EN AW 6060 T66 brut, légèrement huilé

Material

Aluminium EN AW 6060 T66 mill finish, slightly oiled

Profil-Nr.	G kg/m	U m ² /m	P m ² /m	L mm
407.802	0,558	0,190		6000
407.822	0,530	0,163	0,051	6000
407.823	0,076	0,043	0,019	6000
407.865	0,304	0,167	0,082	6000
407.866	0,379	0,205	0,094	6000
407.867	0,432	0,223	0,108	6000
407.868	0,750	0,330	0,160	6000
407.901	0,590	0,255	0,148	6000

Schnittpunkte im Massstab 1:1
Coupe de détails à l'échelle 1:1
Section details on scale 1:1

VISS Semi SG-Fassaden
Façades VISS Semi SG
VISS Semi SG façades

VISS Semi SG HI
Pfosten-Detail
Ansichtsbreite 50 mm

VISS Semi SG HI
Détail de la montante
Largeur de face 50 mm

VISS Semi SG HI
Detail of mullion
Width 50 mm

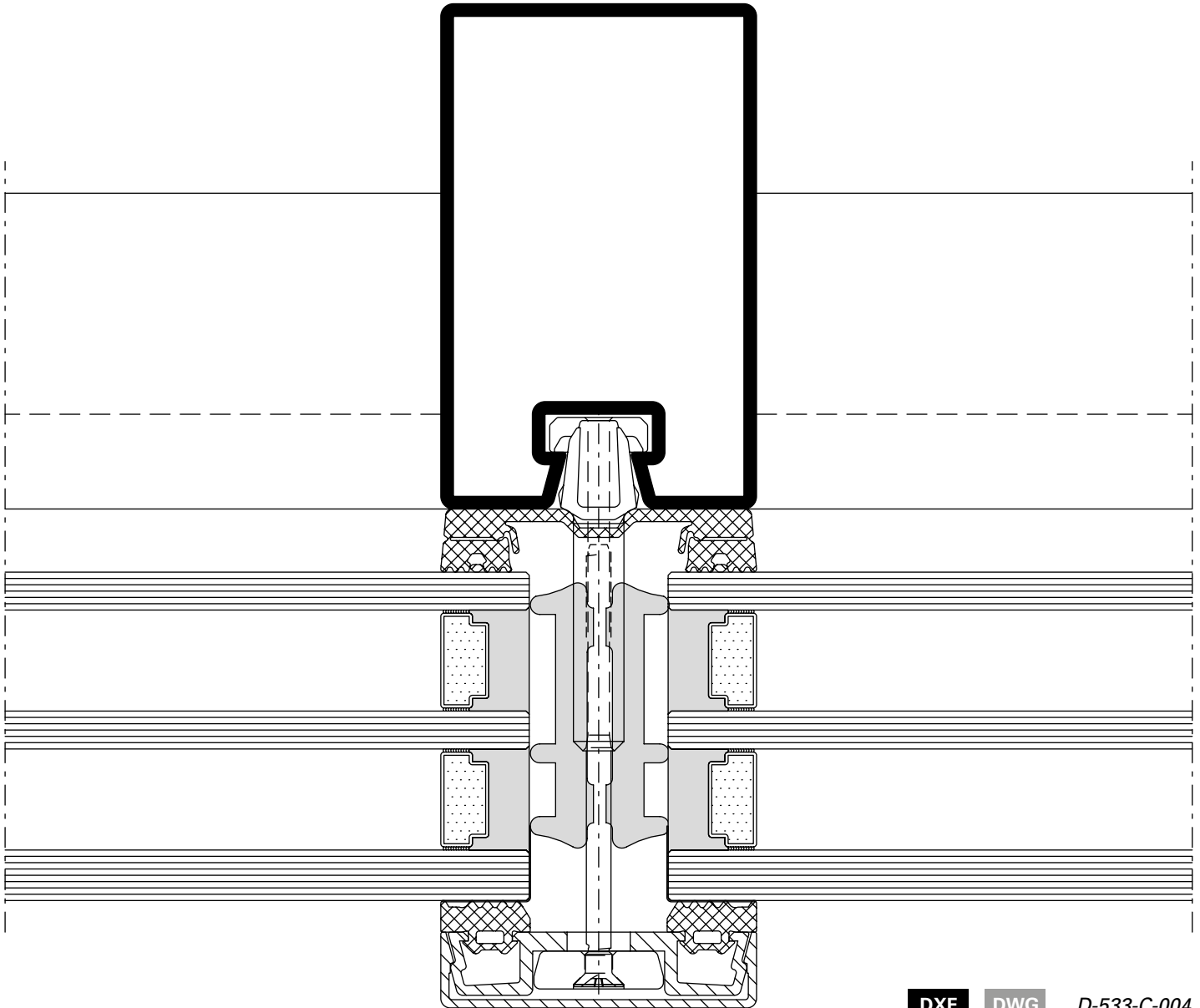

DXF

DWG

D-533-C-004

VISS Semi SG HI
Riegel-Detail
Ansichtsbreite 50 mm

VISS Semi SG HI
Détail de la traverse
Largeur de face 50 mm

VISS Semi SG HI
Detail of transom
Width 50 mm

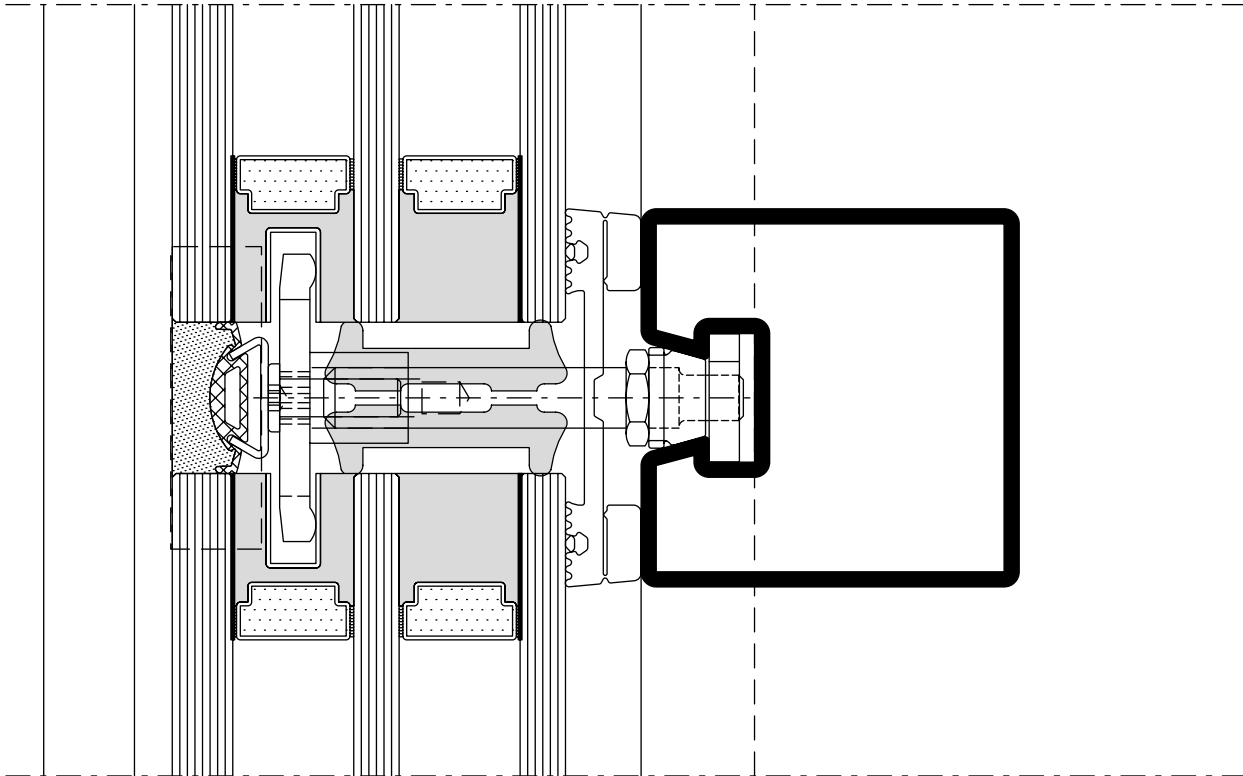

D-533-C-005

DWG

DXF

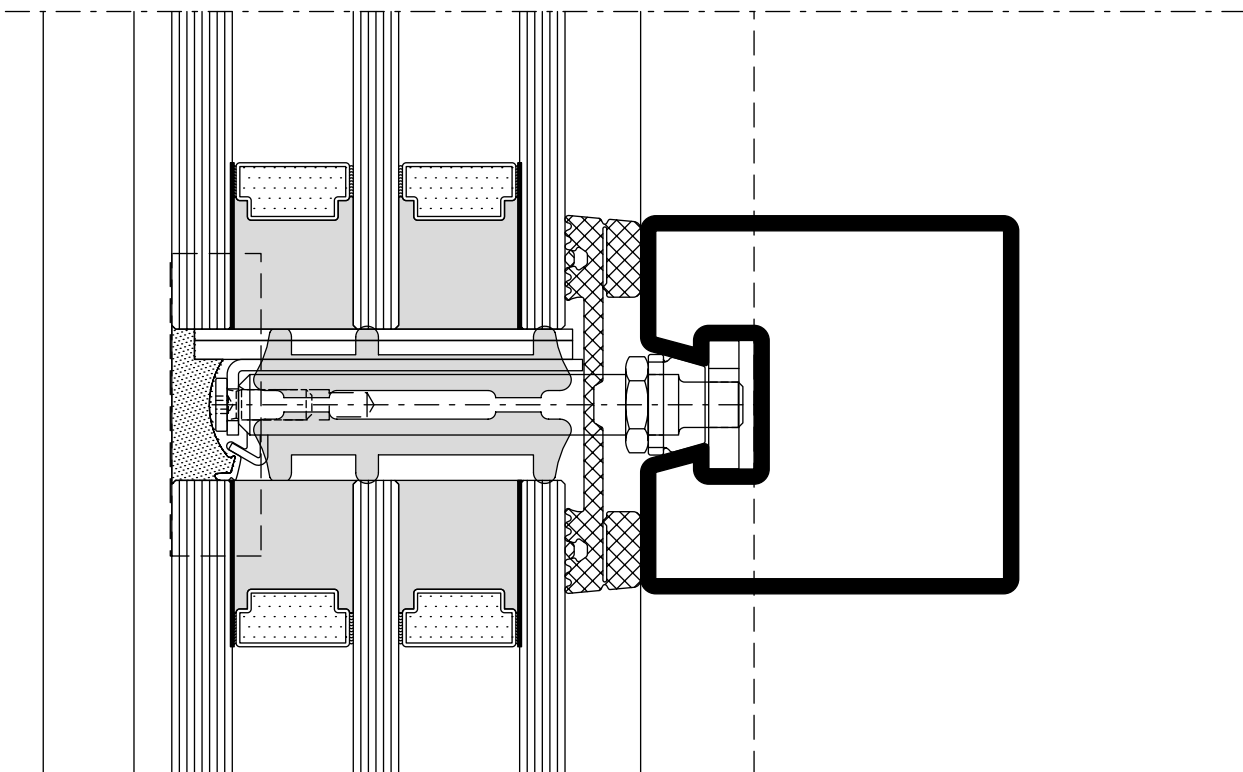

D-533-C-006

DWG

DXF

Schnittpunkte im Massstab 1:1
Coupe de détails à l'échelle 1:1
Section details on scale 1:1

VISS Semi SG-Fassaden
Façades VISS Semi SG
VISS Semi SG façades

VISS Semi SG HI
Pfosten-Detail
Ansichtsbreite 50 mm

VISS Semi SG HI
Détail de la montante
Largeur de face 50 mm

VISS Semi SG HI
Detail of mullion
Width 50 mm

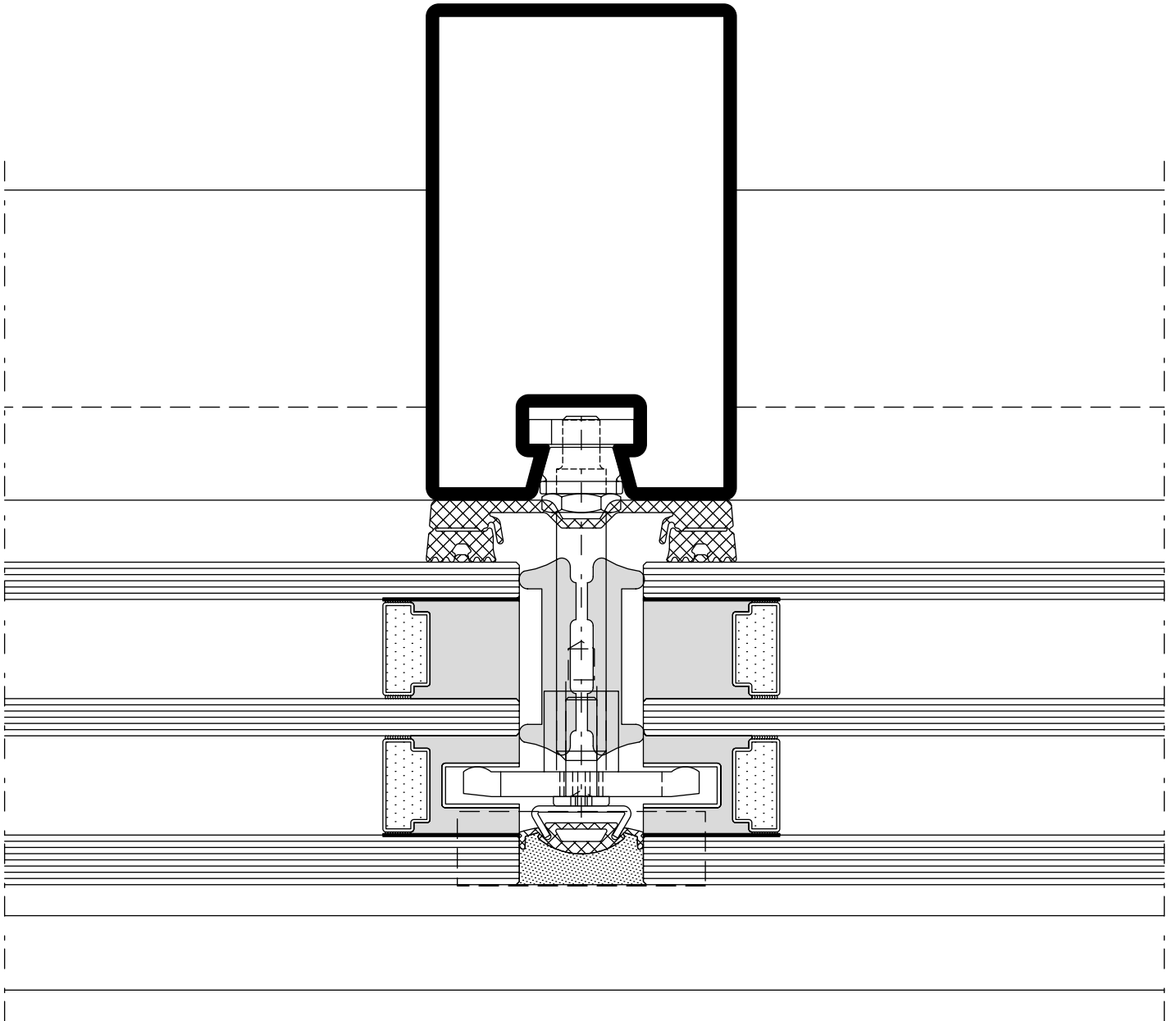

DXF

DWG

D-533-C-010

Schnittpunkte im Massstab 1:1
Coupe de détails à l'échelle 1:1
Section details on scale 1:1

VISS Semi SG-Fassaden
Façades VISS Semi SG
VISS Semi SG façades

VISS Semi SG HI
Riegel-Detail
Ansichtsbreite 50 mm

VISS Semi SG HI
Détail de la traverse
Largeur de face 50 mm

VISS Semi SG HI
Detail of transom
Width 50 mm

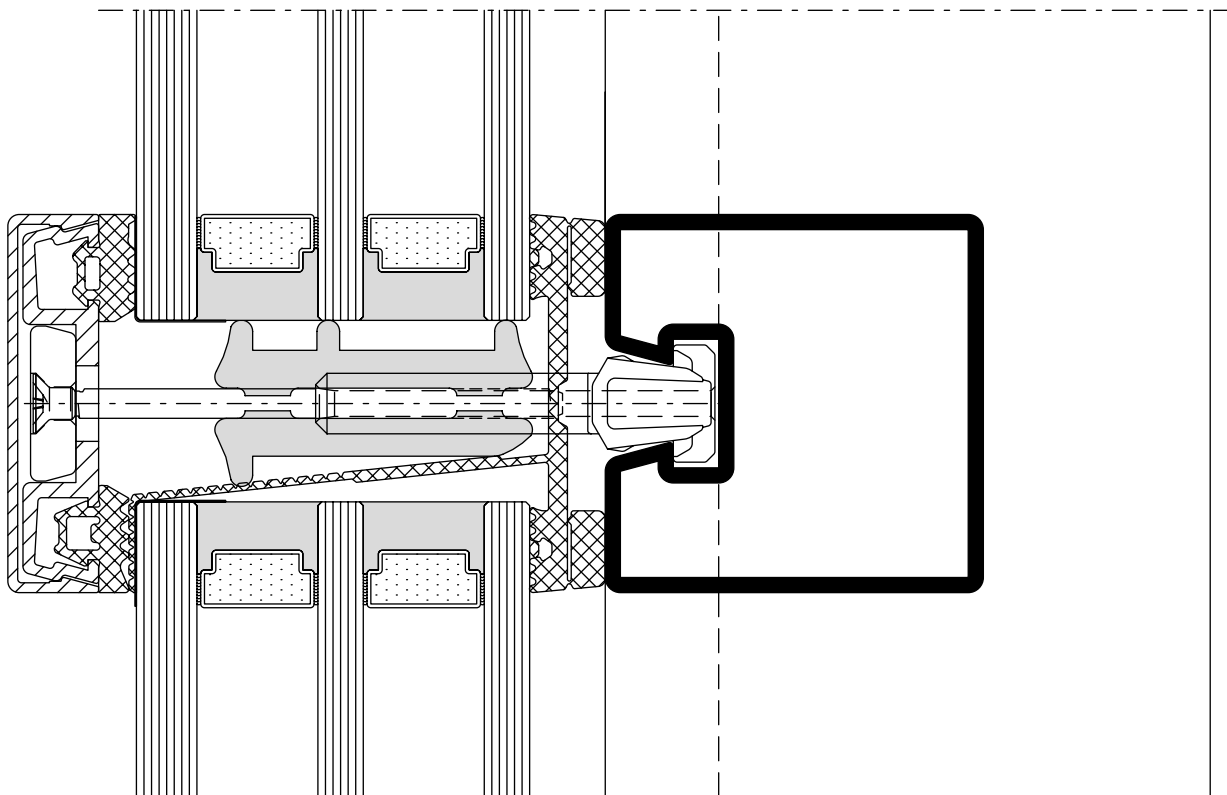

D-533-C-011

DWG

DXF

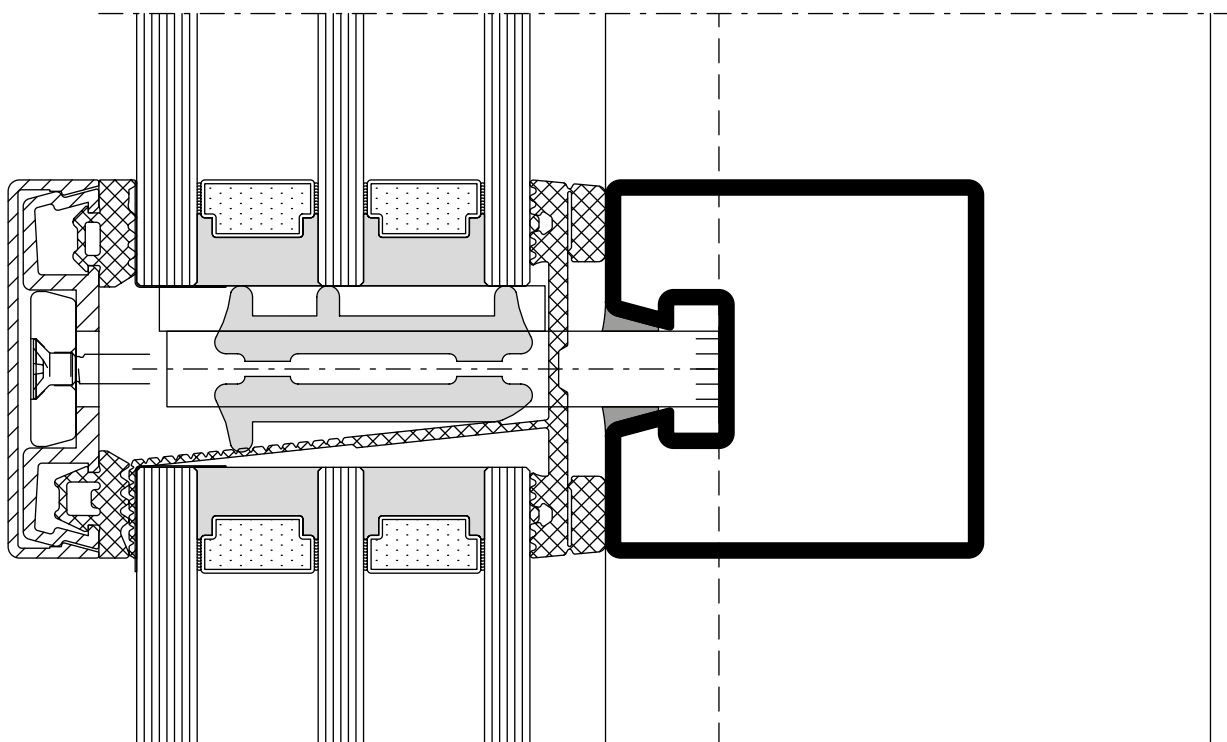

D-533-C-012

DWG

DXF

Schnittpunkte im Massstab 1:1
 Coupe de détails à l'échelle 1:1
 Section details on scale 1:1

VISS Semi SG-Fassaden
 Façades VISS Semi SG
 VISS Semi SG façades

VISS Semi SG
 Pfosten-Detail
 Segmentverglasung 50 mm

VISS Semi SG
 Détail de la montante
 Vitrage segmenté 50 mm

VISS Semi SG
 Detail of mullion
 Segmental glazing 50 mm

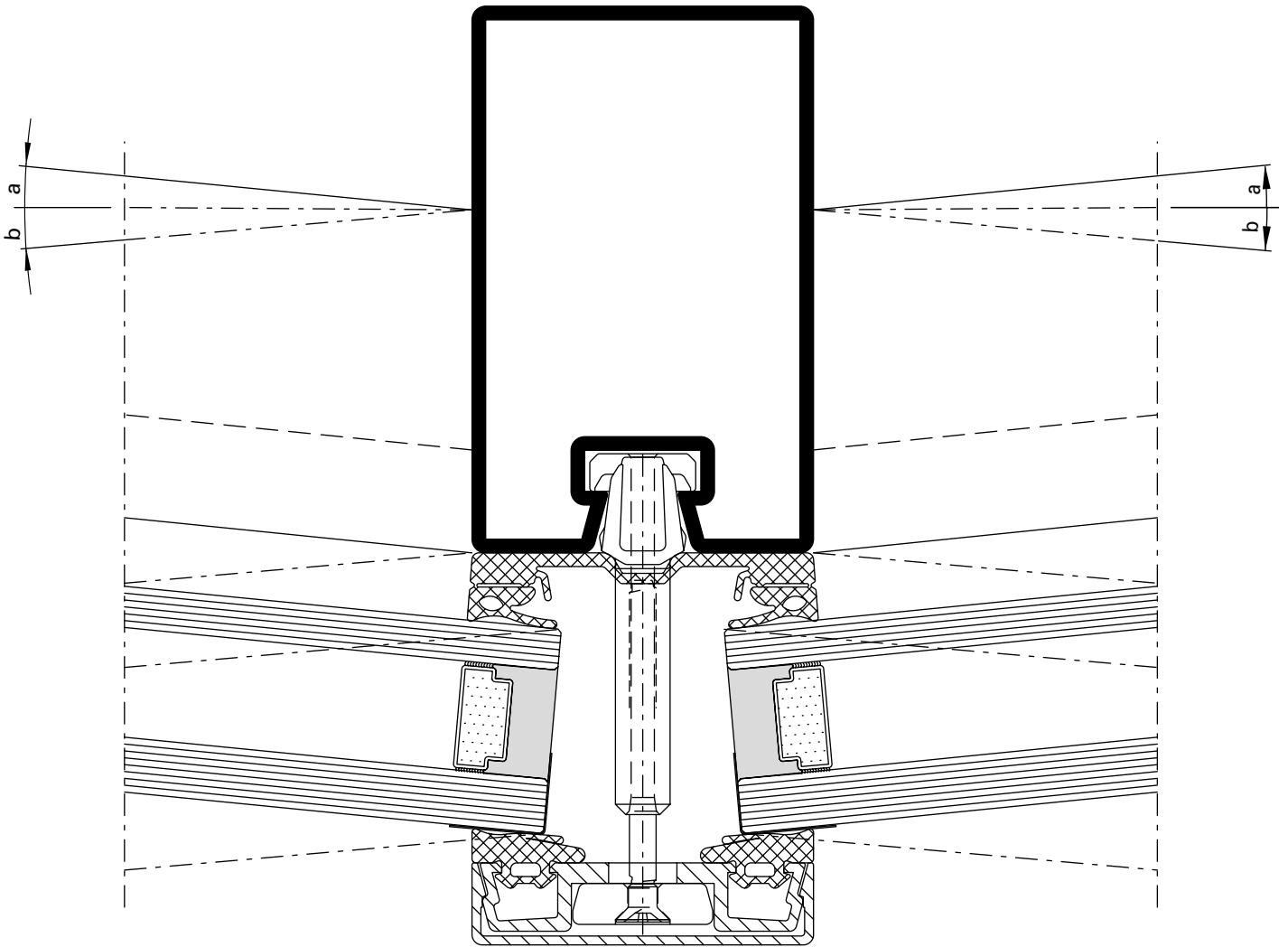

DXF

DWG

D-533-C-013

α β	Füllelement- dicke	X (max) mm	Y (min) mm
0 – 5°	20 – 45 mm	16	5
5 – 10°	20 – 35 mm	18	3
10 – 15°	20 – 24 mm	18	3

α β	Epaisseur du remplissage	X (max) mm	Y (min) mm
0 – 5°	20 – 45 mm	16	5
5 – 10°	20 – 35 mm	18	3
10 – 15°	20 – 24 mm	18	3

α β	Thickness of glass/panel	X (max) mm	Y (min) mm
0 – 5°	20 – 45 mm	16	5
5 – 10°	20 – 35 mm	18	3
10 – 15°	20 – 24 mm	18	3

VISS Semi SG
Pfosten-Detail
Segmentverglasung 50 mm

VISS Semi SG
Détail de la montants
Vitrage segmenté 50 mm

VISS Semi SG
Detail of mullion
Segmental glazing 50 mm

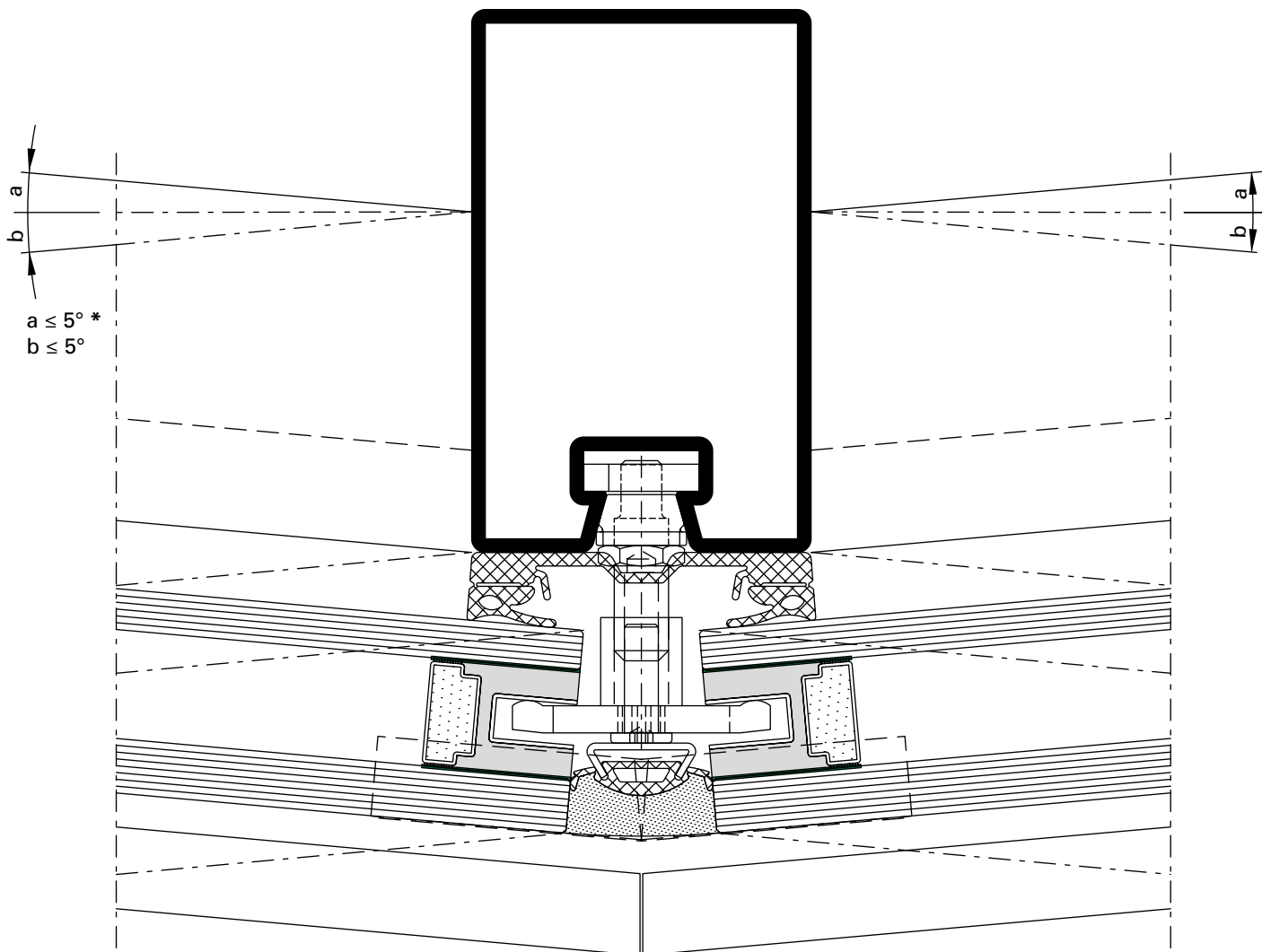

DXF

DWG

D-533-C-014

*** Hinweis**

Dies gilt für Füllelementstärken von 30 - 70 mm bzw. für 2- und 3-fach Verglasungen.

*** Remarque**

Cela est applicable pour les épaisseurs d'élément de remplissage de 30 à 70 mm et pour les vitrages doubles et triples.

*** Note**

This applies to infill unit thicknesses of 30-70 mm and to double and triple glazing.

VISS Semi SG
Ansichtsbreite 60 mm

VISS Semi SG
Largeur de face 60 mm

VISS Semi SG
Width 60 mm

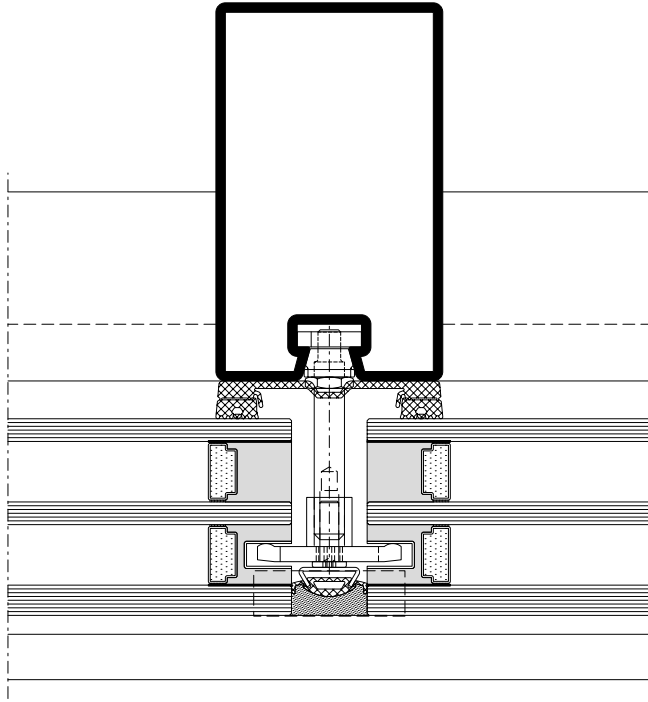

DXF **DWG** *D-633-C-010*

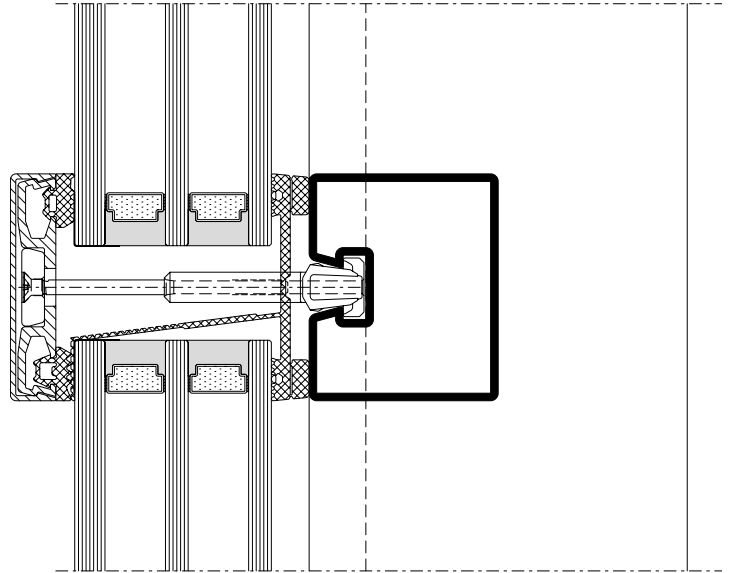

DXF **DWG** *D-633-C-011*

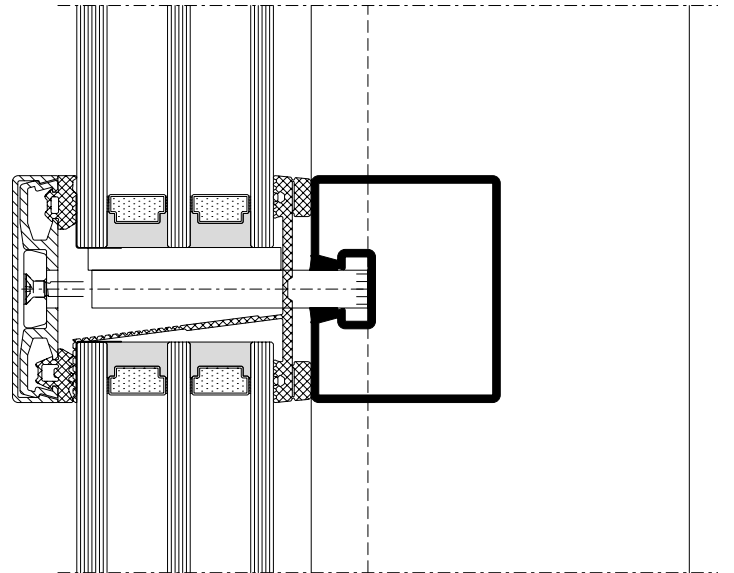

DXF **DWG** *D-633-C-012*

Schnittpunkte im Massstab 1:2
Coupe de détails à l'échelle 1:2
Section details on scale 1:2

VISS Semi SG-Fassaden
Façades VISS Semi SG
VISS Semi SG façades

VISS Semi SG
Ansichtsbreite 60 mm

VISS Semi SG
Largeur de face 60 mm

VISS Semi SG
Width 60 mm

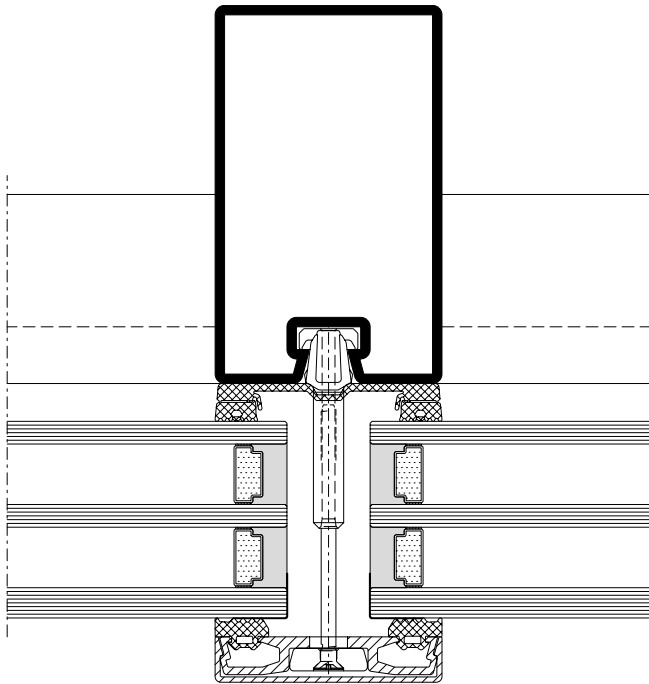

DXF **DWG** *D-633-C-004*

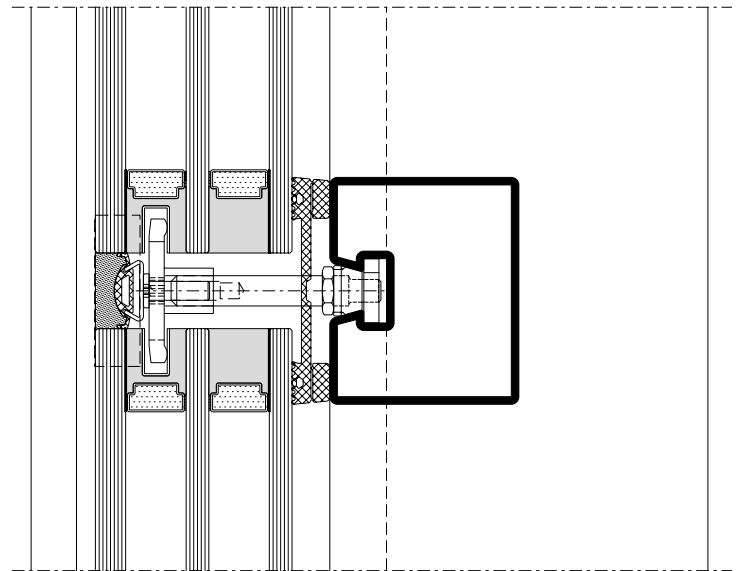

DXF **DWG** *D-633-C-005*

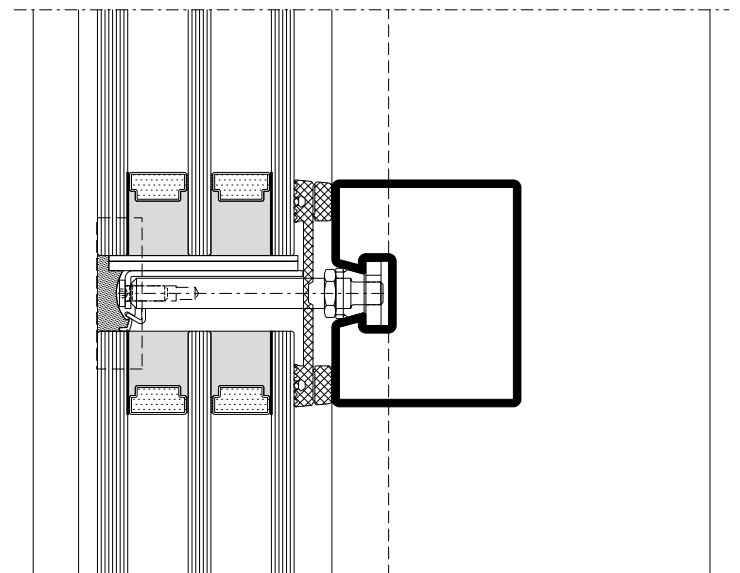

DXF **DWG** *D-633-C-006*

Schnittpunkte im Massstab 1:2
Coupe de détails à l'échelle 1:2
Section details on scale 1:2

VISS Semi SG-Fassaden
Façades VISS Semi SG
VISS Semi SG façades

VISS Semi SG
Ansichtsbreite 50 mm
Flaches Deckprofil

VISS Semi SG
Largeur de face 50 mm
Profilé de recouvrement plat

VISS Semi SG
Width 50 mm
Flat cover cap

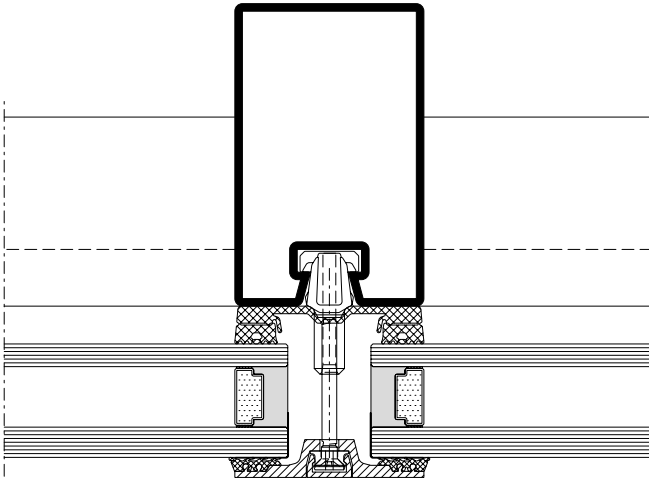

DXF DWG D-533-C-017

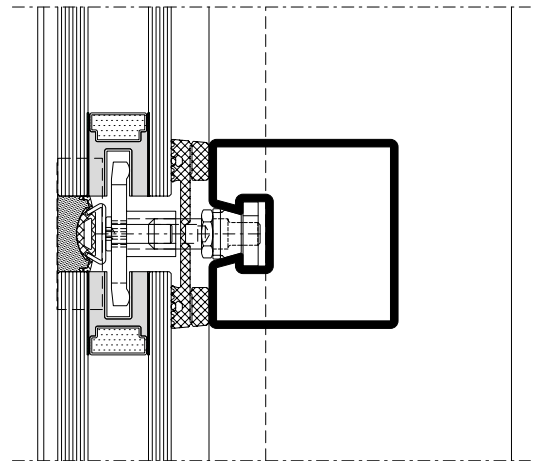

DXF DWG D-533-C-018

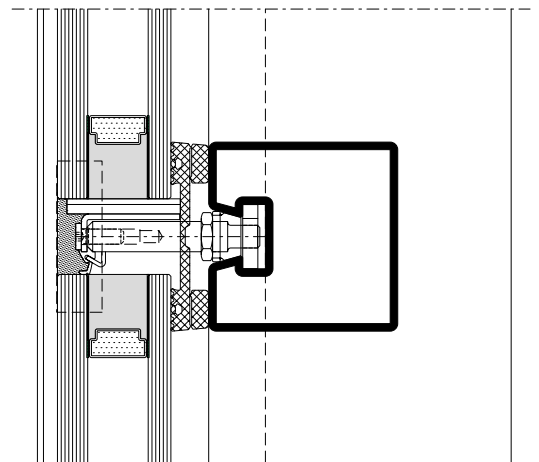

DXF DWG D-533-C-019

Schnittpunkte im Massstab 1:2
Coupe de détails à l'échelle 1:2
Section details on scale 1:2

VISS Semi SG-Fassaden
Façades VISS Semi SG
VISS Semi SG façades

VISS Semi SG
Ansichtsbreite 50 mm
Flaches Deckprofil

VISS Semi SG
Largeur de face 50 mm
Profilé de recouvrement plat

VISS Semi SG
Width 50 mm
Flat cover cap

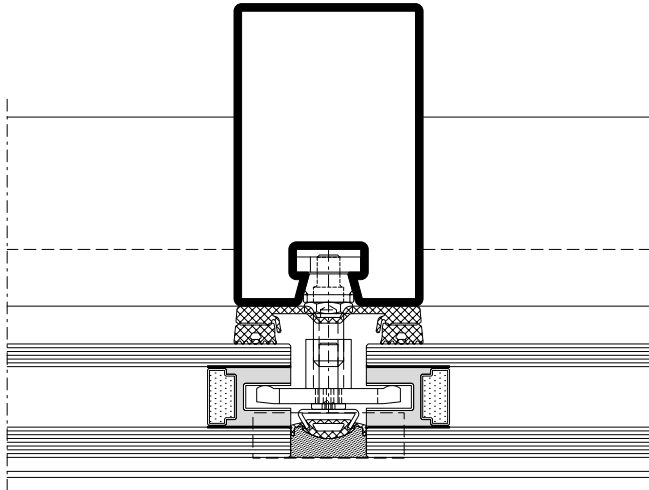

DXF **DWG** *D-533-C-020*

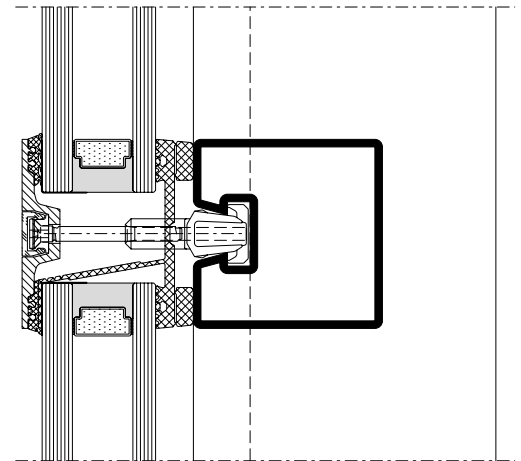

DXF **DWG** *D-533-C-021*

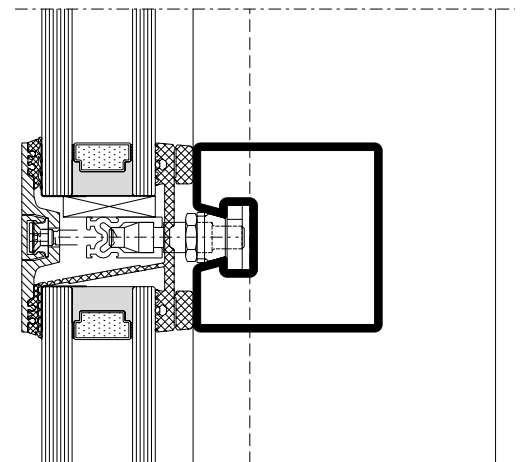

DXF **DWG** *D-533-C-022*

Schnittpunkte im Massstab 1:2
Coupe de détails à l'échelle 1:2
Section details on scale 1:2

VISS Semi SG-Fassaden
Façades VISS Semi SG
VISS Semi SG façades

VISS Semi SG
Ansichtsbreite 60 mm
Flaches Deckprofil

VISS Semi SG
Largeur de face 60 mm
Profilé de recouvrement plat

VISS Semi SG
Width 60 mm
Flat cover cap

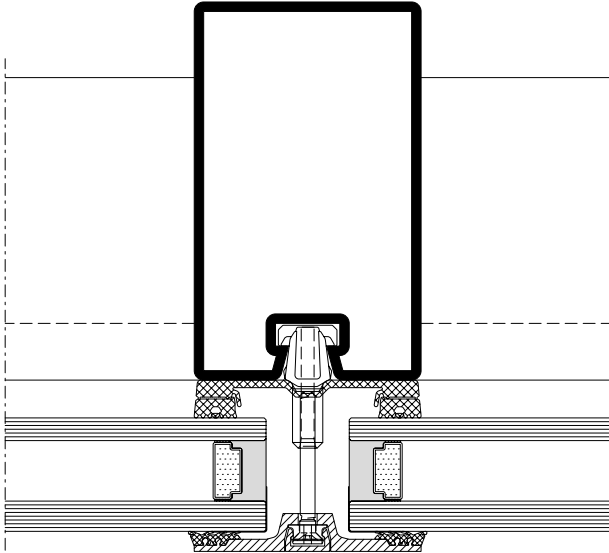

DXF **DWG** D-633-C-016

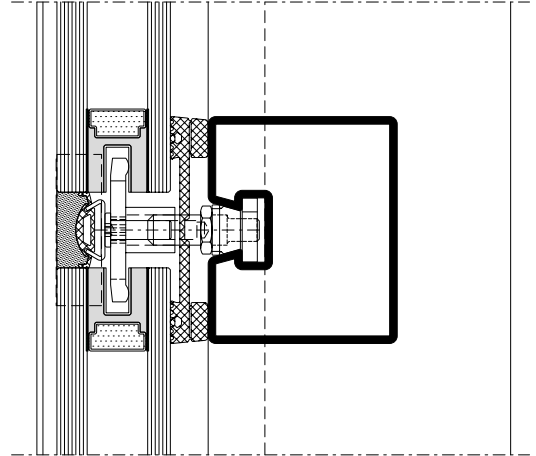

DXF **DWG** D-633-C-017

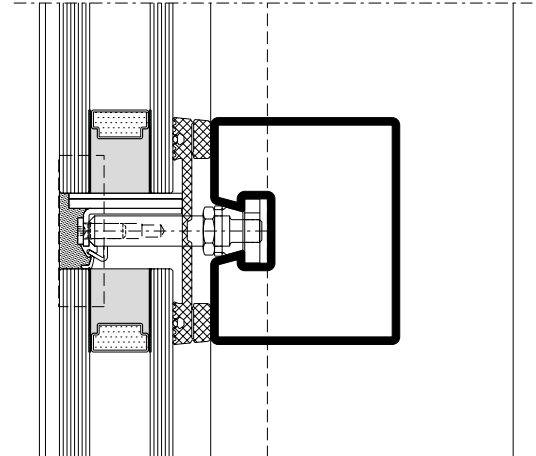

DXF **DWG** D-633-C-018

Schnittpunkte im Massstab 1:2
Coupe de détails à l'échelle 1:2
Section details on scale 1:2

VISS Semi SG-Fassaden
Façades VISS Semi SG
VISS Semi SG façades

VISS Semi SG
Ansichtsbreite 60 mm
Flaches Deckprofil

VISS Semi SG
Largeur de face 60 mm
Profilé de recouvrement plat

VISS Semi SG
Width 60 mm
Flat cover cap

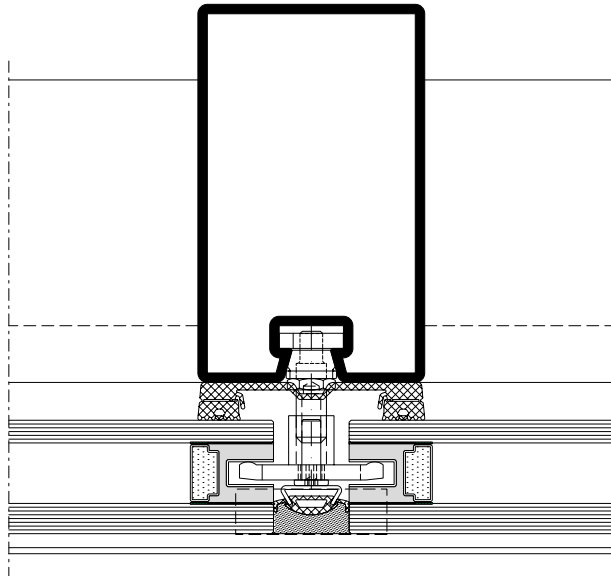

DXF **DWG** D-633-C-019

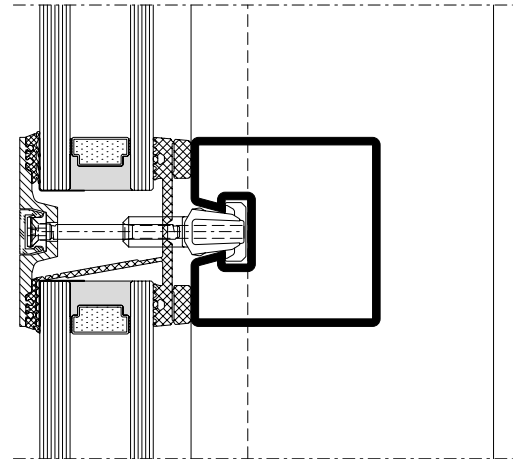

DXF **DWG** D-633-C-020

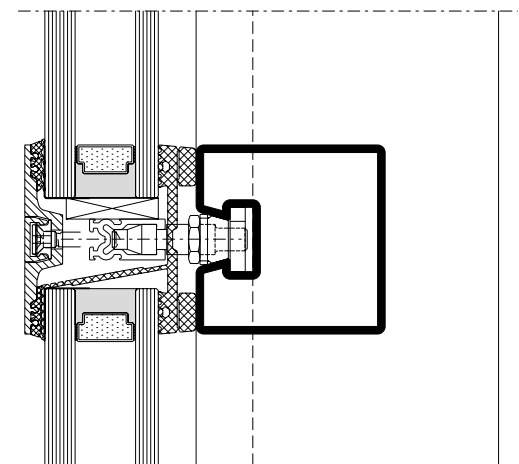

DXF **DWG** D-633-C-021

Schnittpunkte im Massstab 1:2
 Coupe de détails à l'échelle 1:2
 Section details on scale 1:2

VISS Semi SG-Fassaden
 Façades VISS Semi SG
 VISS Semi SG façades

VISS Semi SG
 Pfosten-Detail
 Segmentverglasung 60 mm

VISS Semi SG
 Détail de la montante
 Vitrage segmenté 60 mm

VISS Semi SG
 Detail of mullion
 Segmental glazing 60 mm

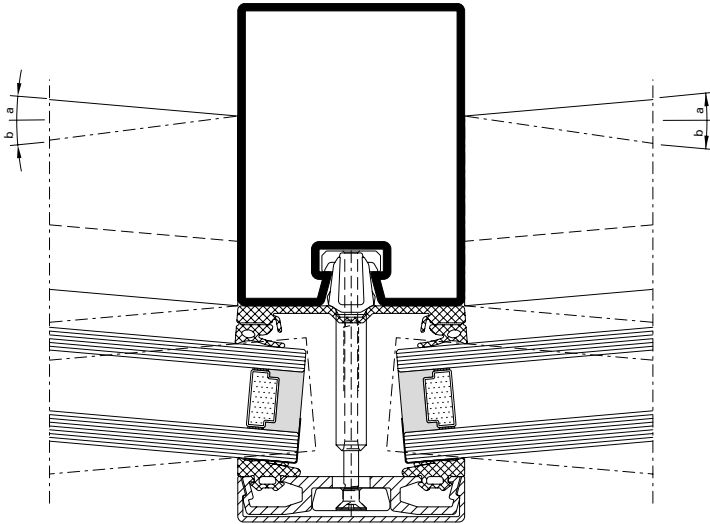

DXF

DWG

D-633-C-013

α β	Füllelement- dicke	x (max) mm	y (min) mm
0 – 5°	20 – 45 mm	16	5
5 – 10°	20 – 35 mm	18	3
10 – 15°	20 – 24 mm	18	3

α β	Epaisseur du remplissage	x (max) mm	y (min) mm
0 – 5°	20 – 45 mm	16	5
5 – 10°	20 – 35 mm	18	3
10 – 15°	20 – 24 mm	18	3

α β	Thickness of glass/panel	x (max) mm	y (min) mm
0 – 5°	20 – 45 mm	16	5
5 – 10°	20 – 35 mm	18	3
10 – 15°	20 – 24 mm	18	3

Schnittpunkte im Massstab 1:2
Coupe de détails à l'échelle 1:2
Section details on scale 1:2

VISS Semi SG-Fassaden
 Façades VISS Semi SG
 VISS Semi SG façades

VISS Semi SG
Pfosten-Detail
Segmentverglasung 60 mm

VISS Semi SG
Détail de la montante
Vitrage segmenté 60 mm

VISS Semi SG
Detail of mullion
Segmental glazing 60 mm

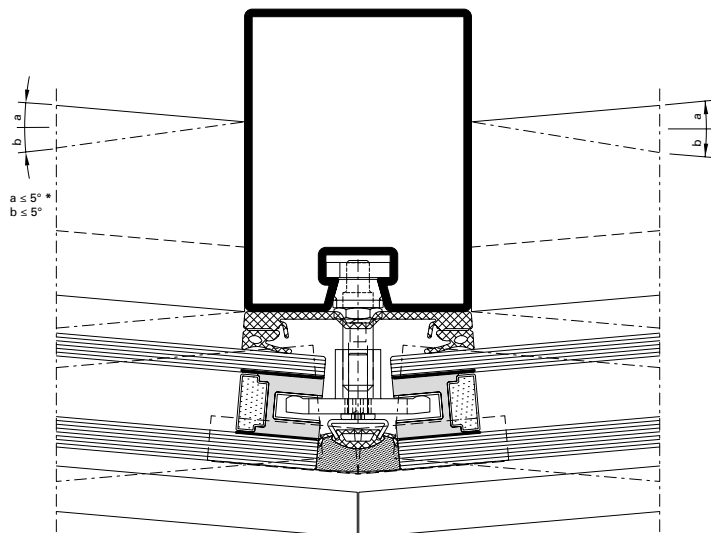

DXF **DWG** *D-633-C-014*

α	Füllelement- dicke	X (max) mm	Y (min) mm
β			
0 – 5°	20 – 45 mm	16	5
5 – 10°	20 – 35 mm	18	3
10 – 15°	20 – 24 mm	18	3

α	Epaisseur du remplissage	X (max) mm	Y (min) mm
β			
0 – 5°	20 – 45 mm	16	5
5 – 10°	20 – 35 mm	18	3
10 – 15°	20 – 24 mm	18	3

α	Thickness of glass/panel	X (max) mm	Y (min) mm
β			
0 – 5°	20 – 45 mm	16	5
5 – 10°	20 – 35 mm	18	3
10 – 15°	20 – 24 mm	18	3

*** Hinweis**
 Dies gilt für Füllelementstärken
 von 30 - 70 mm bzw. für 2- und 3-fach
 Verglasungen.

*** Remarque**
 Cela est applicable pour les épaisseurs
 d'élément de remplissage de 30 à
 70 mm et pour les vitrages doubles
 et triples.

*** Note**
 This applies to infill unit thicknesses
 of 30-70 mm and to double and triple
 glazing.

Anschlüsse am Bau im Massstab 1:2
Raccords au mur à l'échelle 1:2
Attachment to structure on scale 1:2

VISS Semi SG-Fassaden
Façades VISS Semi SG
VISS Semi SG façades

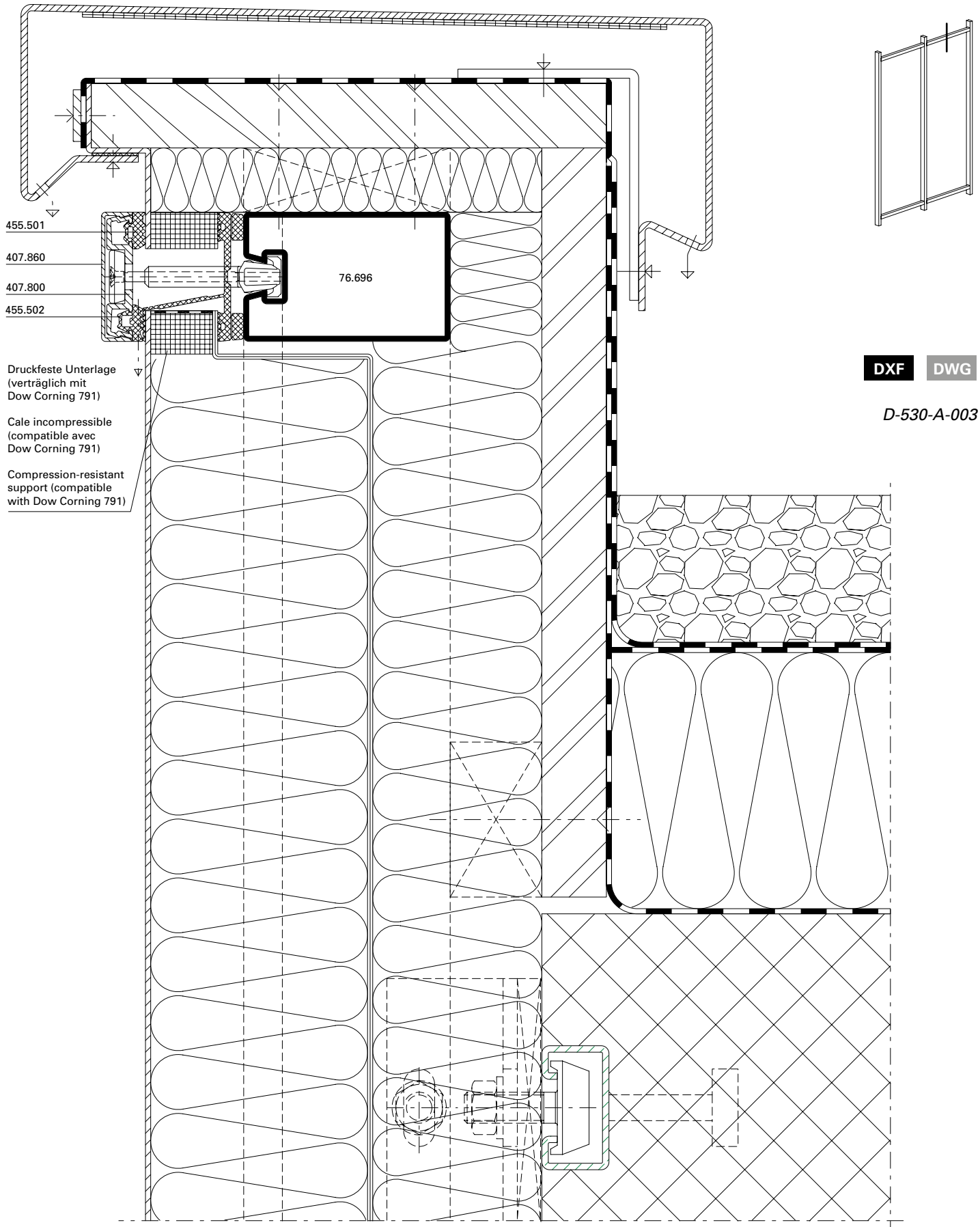

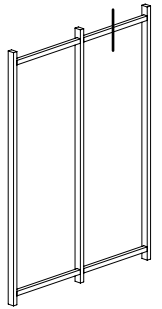
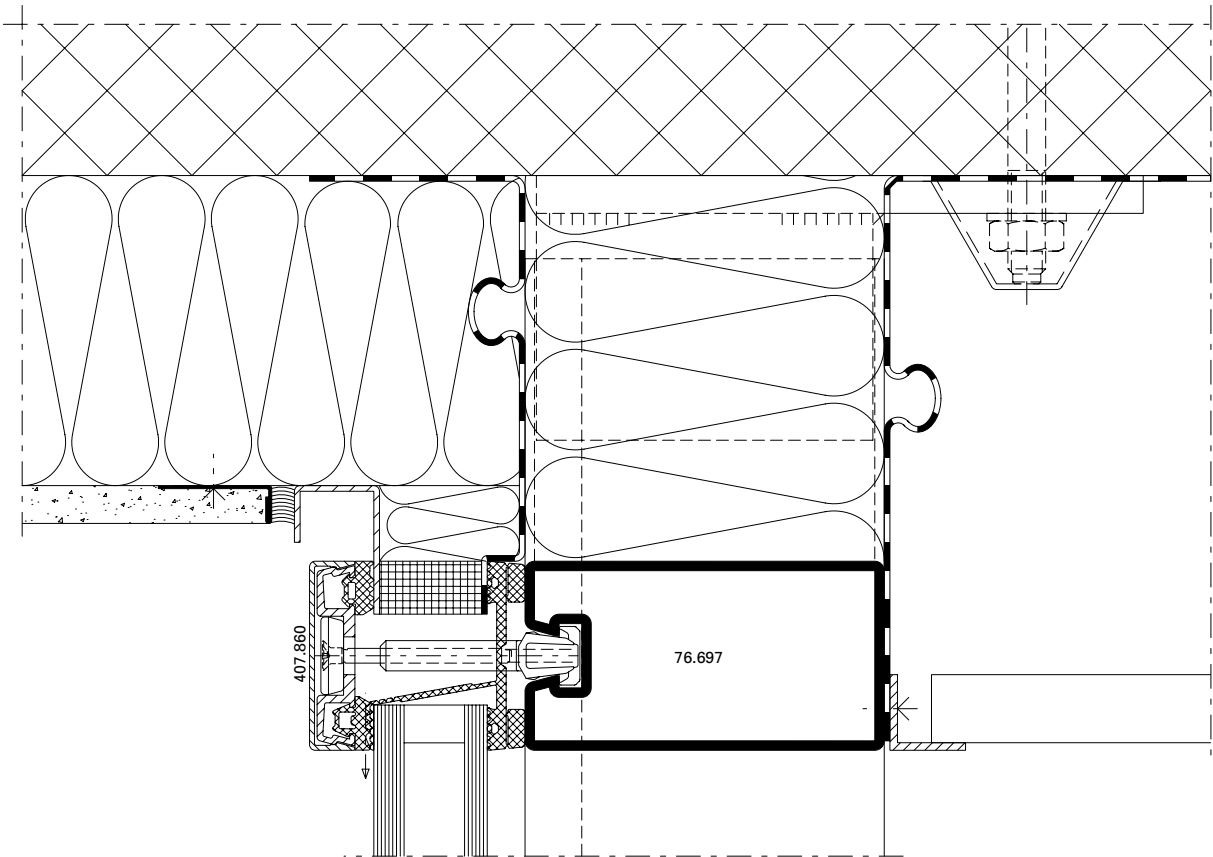

DXF DWG

D-530-A-001

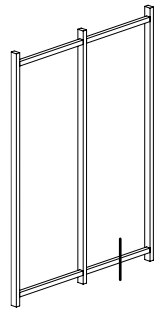
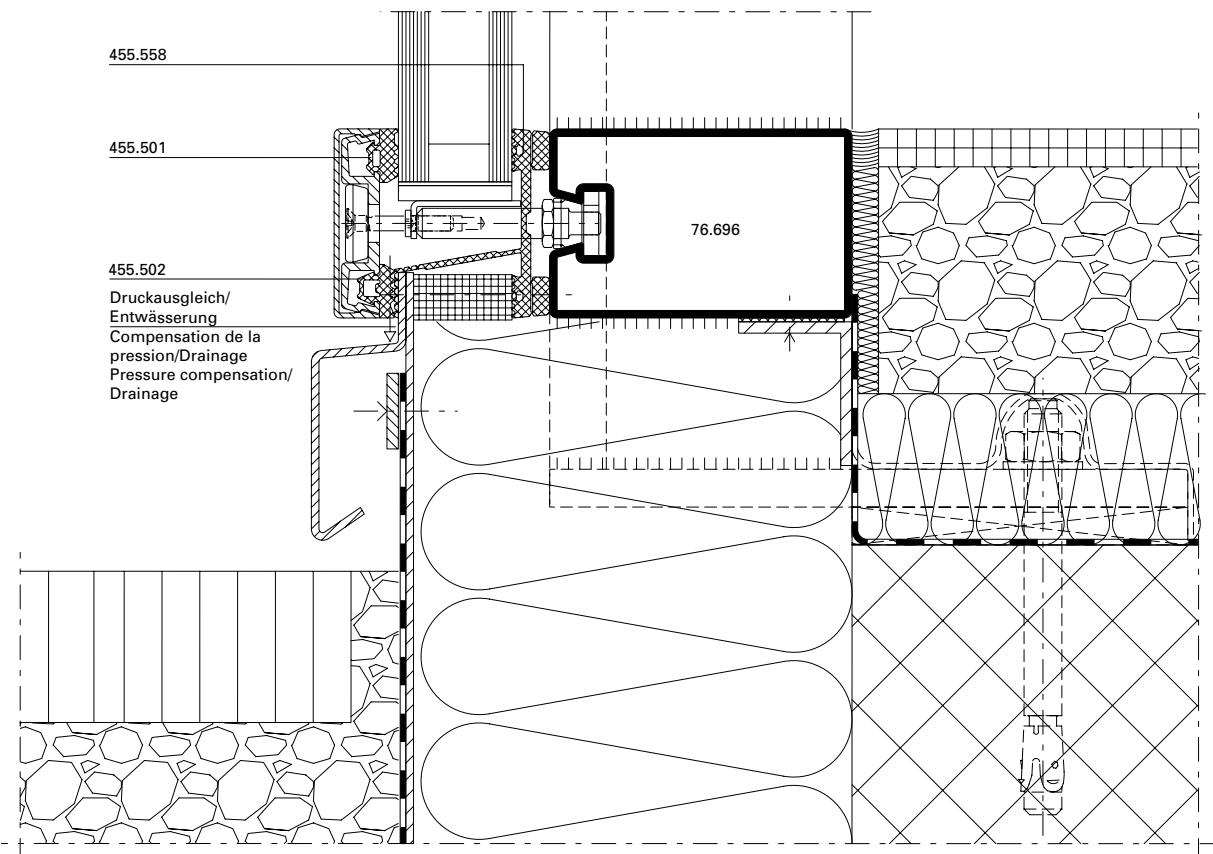

DXF DWG

D-530-A-002

System-Hinweise**Remarques concernant les systèmes****System instructions**

VISS Semi SG-Fassaden

Façades VISS Semi SG

VISS Semi SG façades

Die U_i -Werte der VISS Semi SG Fassaden sind den Kapiteln VISS SG und VISS Fassade zu entnehmen.

Les valeurs U_f des façades VISS Semi SG figurent dans les chapitres VISS SG et VISS Façade.

The U_i values for the VISS Semi SG façades can be found in the VISS SG and VISS Façade sections.

Inhaltsverzeichnis Sommaire Content	VISS Basic SG-Fassaden Façades VISS Basic SG VISS Basic SG façades	56
Systemübersicht	Sommaire du système	
Merkmale Leistungseigenschaften	Caractéristiques Caractéristiques de performance	Characteristics Performance characteristics
Beispiele	Exemples	59
Schnittpunkte Konstruktionsdetails Anschlüsse am Bau	Coupe de détails Détails de construction Raccords au mur	
Systemhinweise	Remarque concernant les systèmes	63

Merkmale
Caractéristiques
Characteristics





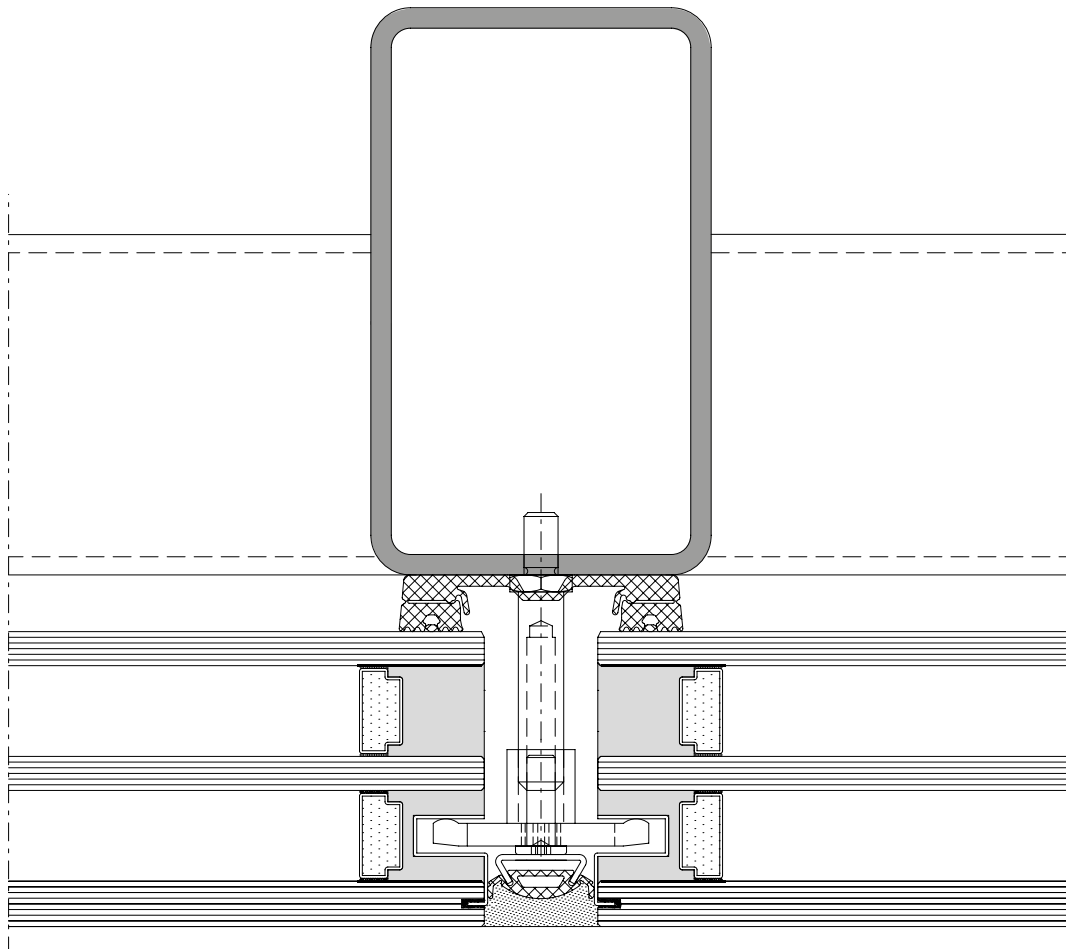

VISS Basic SG-Fassaden
Façades VISS Basic SG
VISS Basic SG façades

- CE-Kennzeichnung nach ETAG 002
- ETA Zulassung für Vorhangfassade und Dachverglasung
- Glasflächen bis 2.5 x 5 m (b x h) bzw. 5 x 2.5 m (b x h)
- Mechanische Sicherung der Gläser - kein Verkleben notwendig
- Zweifach- und Dreifach-Isolierglas Glasstärken bis 30 - 70 mm
- Realisierung von VISS SG und VISS Semi-SG Lösungen
- Einfache Realisierung von Ganzglas-Ecklösungen
- Kombinierbar mit der VISS Standard Fassade
- Absturzsichernde Verglasung nach DIN 18008

- Marquage CE selon ETAG 002
- Homologation ETA pour façade-rideau et verrière
- Surfaces vitrées jusqu'à 2.5 x 5 m (la x h) et 5 x 2.5 m (la x h)
- Sécurité mécanique des vitres - inutile de coller
- Verre isolant double ou triple, épaisseurs de verre jusqu'à 30 à 70 mm
- Réalisation de solutions VISS SG et VISS Semi SG
- Réalisation simple d'angles tout verre
- Combinable avec la façade VISS standard
- Sécurité anti-chute des vitrages selon DIN 18008

- CE marking in accordance with ETAG 002
- ETA approval for curtain walling and roof glazing
- Glass surfaces of up to 2.5 x 5 m (w x h) or 5 x 2.5 m (w x h)
- Mechanical fixing of the glass - no bonding required
- Double and triple insulating glass thicknesses of up to 30 - 70 mm
- Implementation of VISS SG and VISS Semi SG solutions
- Easy implementation of all-glass corner solutions
- Can be combined with the VISS Standard façade
- protecting glazing against falling out in accordance with DIN 18008



	Prüfungen (Prüfnorm) Essais (Norme d'essai) Tests (Test standard)	Klassifizierungs-Norm Norme de classification Classification standard	Werte Valeurs Values
	Schlagregendichtheit (EN 12155) Etanchéité à la pluie battante (EN 12155) Watertightness (EN 12155)	EN 12154	RE 1200
	Widerstand bei Windlast (EN 12179) Résistance à la pression du vent (EN 12179) Resistance to wind load (EN 12179)	EN 13116	Bemessungslast 2 kN/m ² Charge de calcul 2 kN/m ² Designed load 2 kN/m ²
	Luftdurchlässigkeit (EN 12153) Perméabilité à l'air (EN 12153) Air permeability (EN 12153)	EN 12152	Klasse AE Classe AE Class AE
	Wärmedurchgangskoeffizient (EN 13947) Transmission thermique (EN 13947) Thermal production (EN 13947)	EN ISO 10077-2	ab $U_f > 0.54 \text{ W/m}^2\text{K}$ dès $U_f > 0.54 \text{ W/m}^2\text{K}$ from $U_f > 0.54 \text{ W/m}^2\text{K}$
	Stoßfestigkeit Résistance au chocs Impact strength	EN 14019	Klasse E5 / I5 Classe E5 / I5 Class E5 / I5
	Technische Regeln für die Verwendung von absturzsichernden Verglasungen Règlement technique pour la sécurité anti-chute des vitrages The technical regulations for protecting glazing against falling out	DIN 18008-4	Kategorie A, C2, C3 Catégorie A, C2, C3 Category A, C2, C3
	Europäische technische Zulassung (ETA) Homologation technique européenne (ETA) European Technical Approval (ETA)	ETAG 002	ETA 13/0015

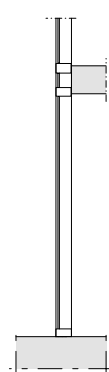
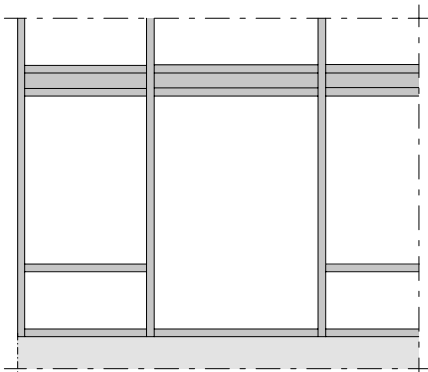
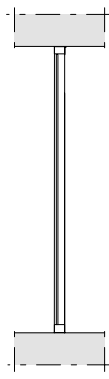
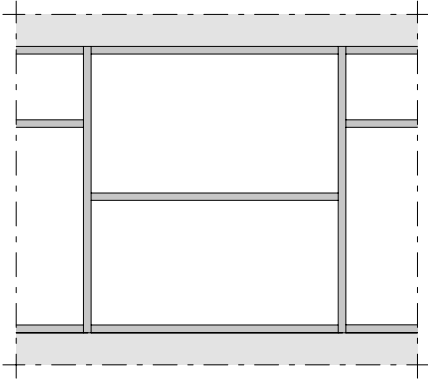
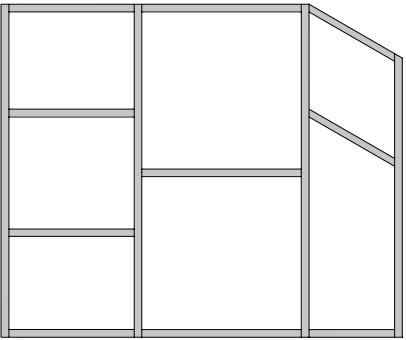
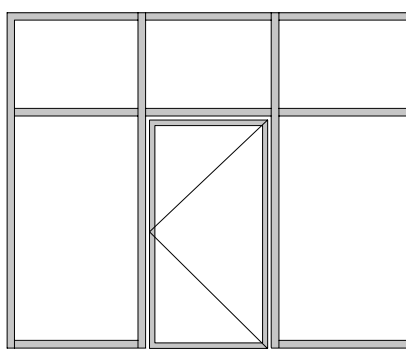
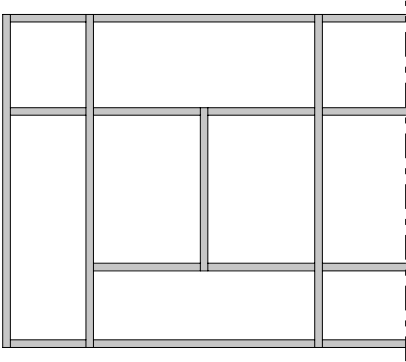

Schnittpunkte im Massstab 1:1
Coupe de détails à l'échelle 1:1
Section details on scale 1:1

VISS Basic SG-Fassaden
Façades VISS Basic SG
VISS Basic SG façades

VISS Basic SG
Pfosten-Detail
Ansichtsbreite 50 mm
Schraubbolzen

VISS Basic SG
Détail du montant
Largeur de face 50 mm
Goujon à visser

VISS Basic SG
Detail of mullion
Width 50 mm
Screw bolt

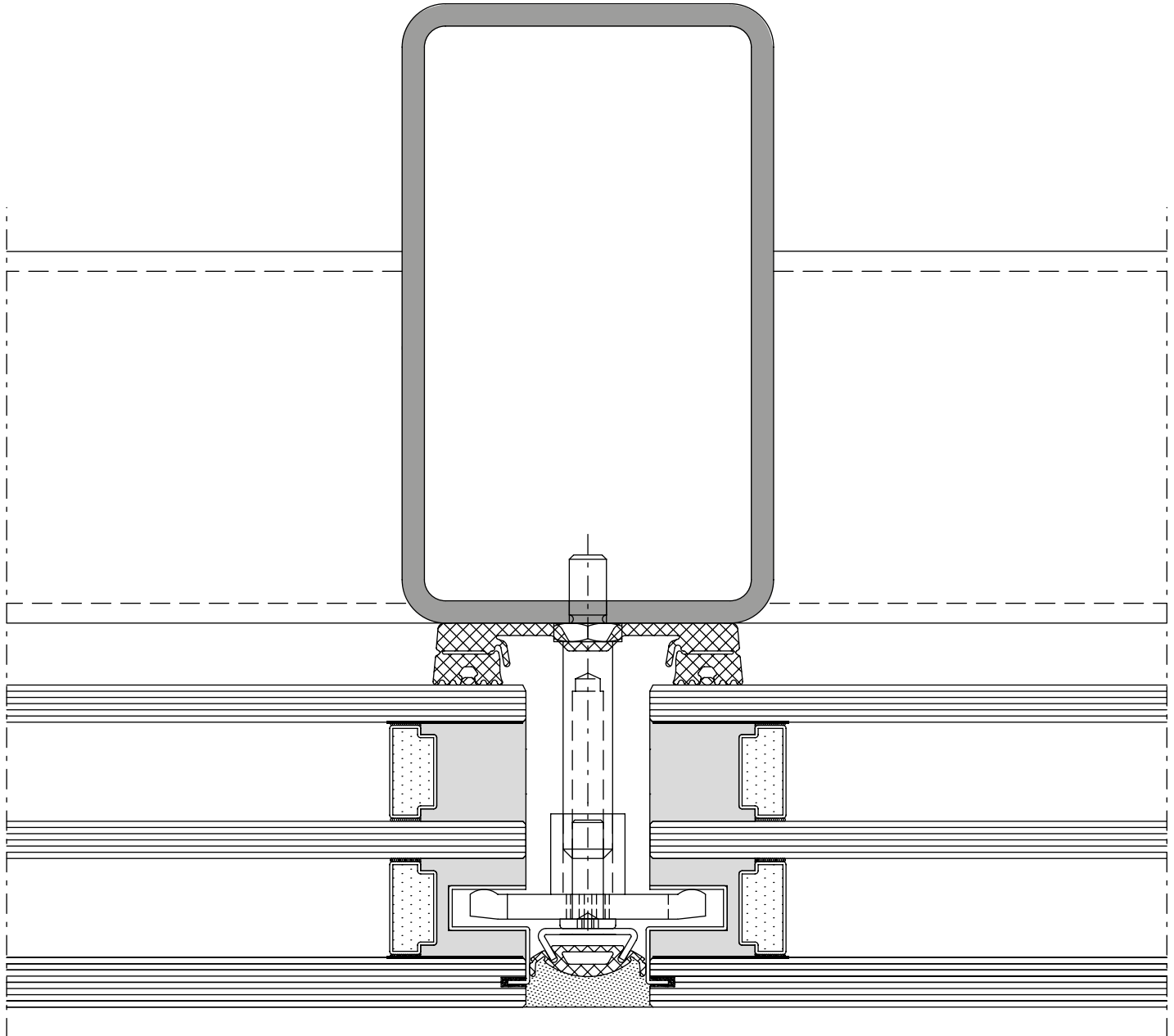

DXF

DWG

D-531-C-002

Schnittpunkte im Massstab 1:1
Coupe de détails à l'échelle 1:1
Section details on scale 1:1

VISS Basic SG-Fassaden
Façades VISS Basic SG
VISS Basic SG façades

VISS Basic SG
Pfosten-Detail
Ansichtsbreite 50 mm
Schweissbolzen

VISS Basic SG
Détail du montant
Largeur de face 50 mm
Goujon à souder

VISS Basic SG
Detail of mullion
Width 50 mm
Welding stud

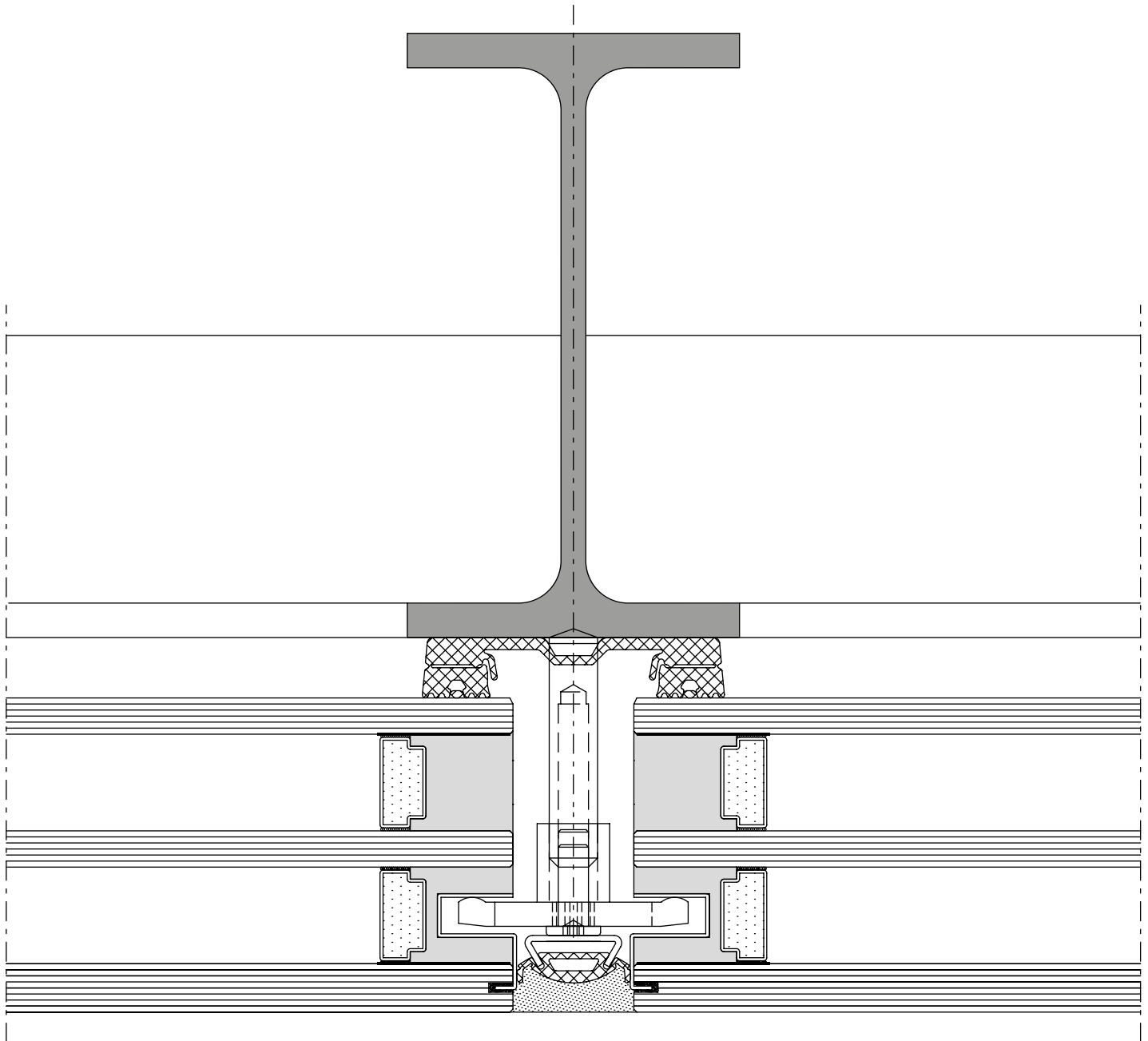

DXF

DWG

D-532-C-002

U_f -Werte siehe Seite 26-60

Valeurs U_f voir page 26-60

U_f values see page 26-60

VISS Basic SG
Riegel-Detail
Ansichtsbreite 50 mm

VISS Basic SG
Détail de la traverse
Largeur de face 50 mm

VISS Basic SG
Detail of transom
Width 50 mm

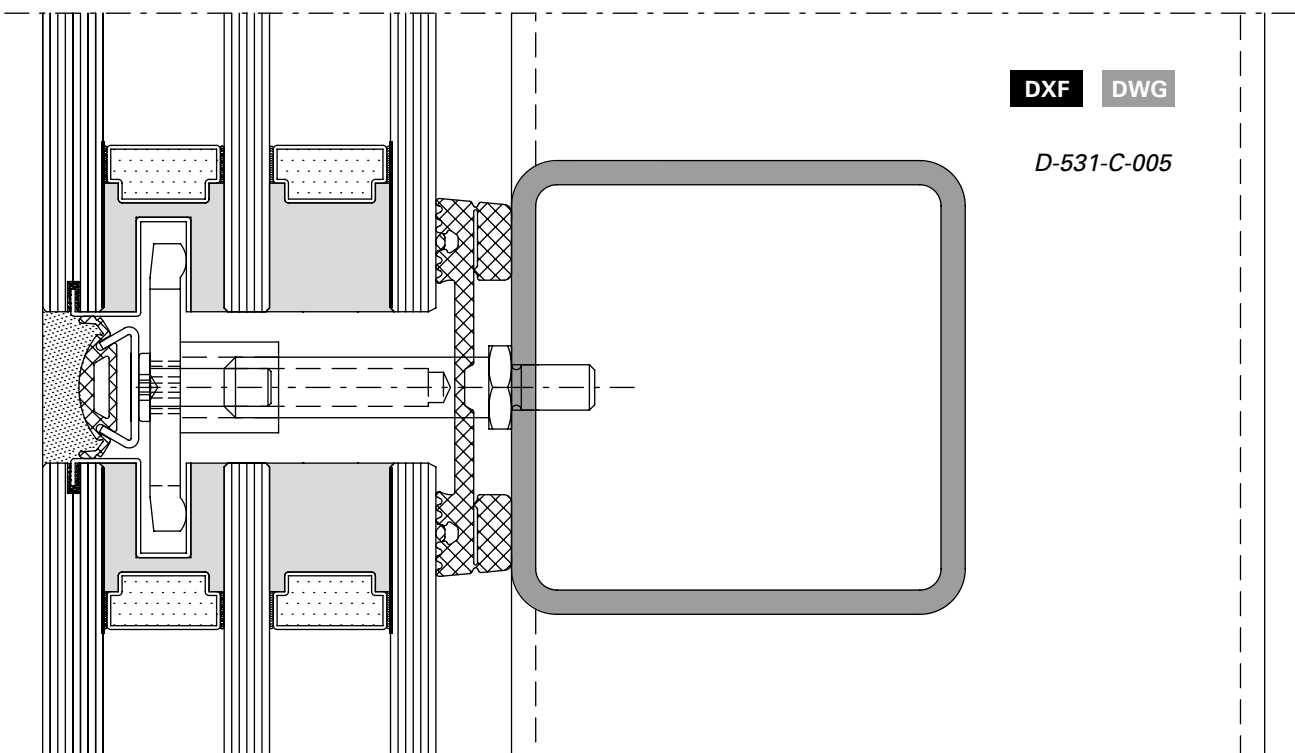
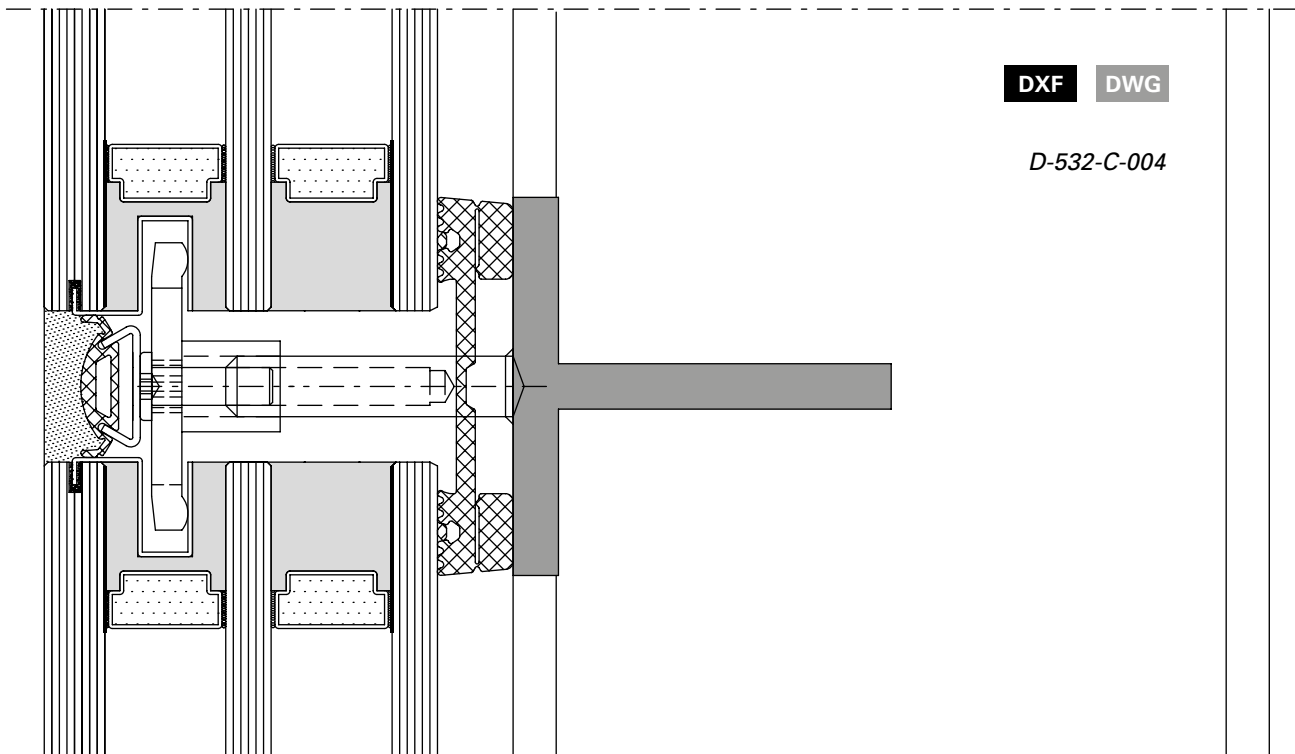

VISS Basic SG
Riegel-Detail
Ansichtsbreite 50 mm
Schweissbolzen

VISS Basic SG
Détail de la traverse
Largeur de face 50 mm
Goujon à souder

VISS Basic SG
Detail of transom
Width 50 mm
Welding stud

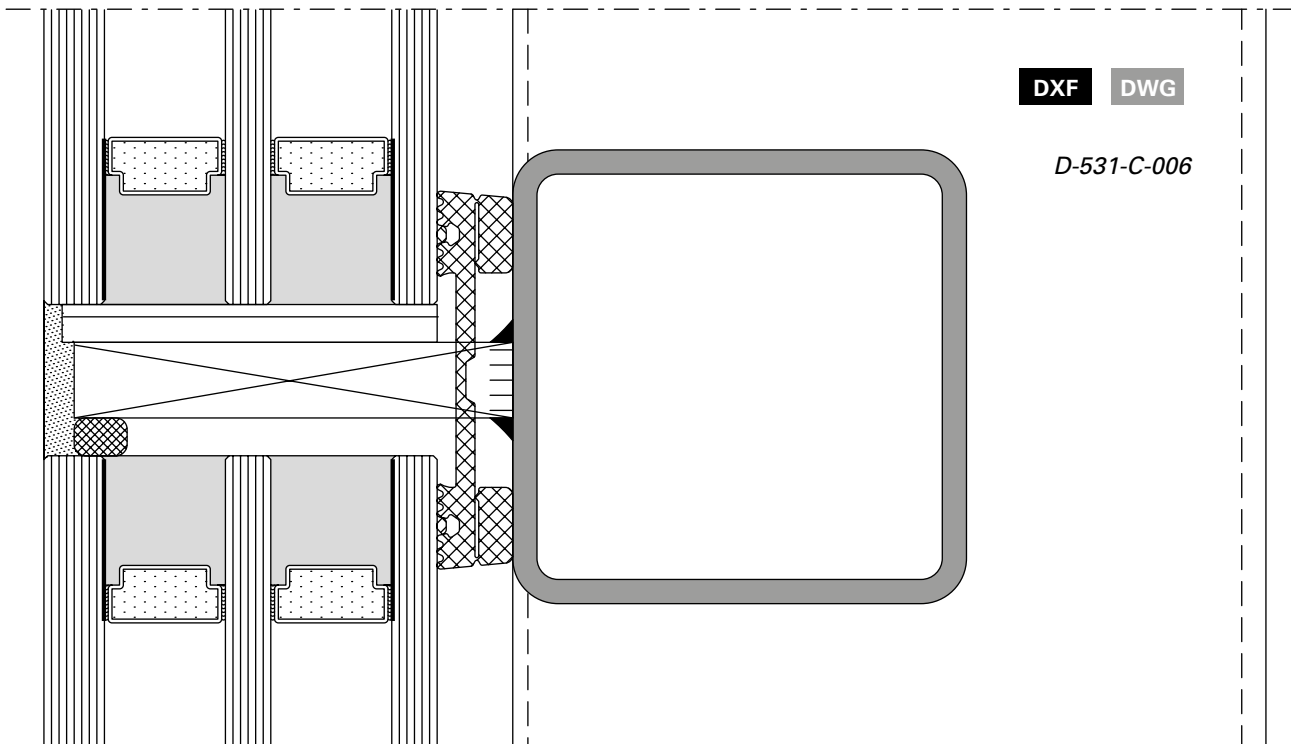
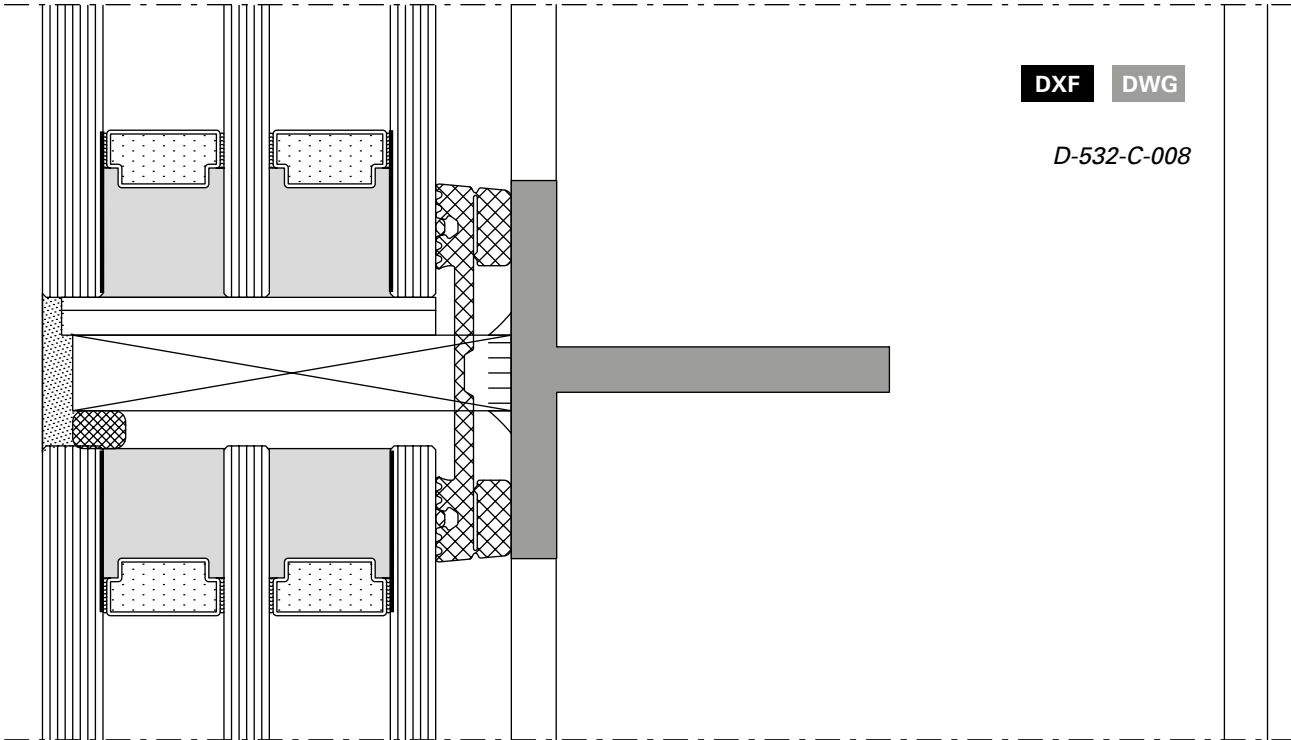

System-Hinweise

Remarques concernant les systèmes

System instructions

VISS Basic SG-Fassaden

Façades VISS Basic SG

VISS Basic SG façades

VISS Basic SG

Ansichtsbreiten 50/60 mm

U_f-Werte nach EN 10077-2**VISS Basic SG**

Largeurs de face 50/60 mm

Valeurs U_f selon EN 10077-2**VISS Basic SG**

Widths 50/60 mm

U_f values according to 10077-2

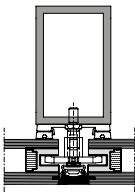
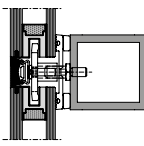
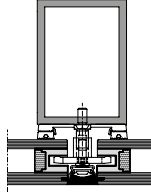
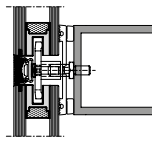
				
Glas Verre Glass	Pfosten 50/80/4 Montant 50/80/4 Mullion 50/80/4	Riegel 50/50/4 Traverse 50/50/4 Transom 50/50/4	Pfosten 60/80/4 Montant 60/80/4 Mullion 60/80/4	Riegel 60/60/4 Traverse 60/60/4 Transom 60/60/4
50 mm	1,1 W/m²K	1,3 W/m²K	1,2 W/m²K	0,71 W/m²K
60 mm	1,1 W/m²K	1,3 W/m²K	1,1 W/m²K	0,61 W/m²K
70 mm	1,0 W/m²K	1,2 W/m²K	1,1 W/m²K	0,54 W/m²K

Der Einfluss der Schraubenbefestigung in Höhe von 0.30 W/m²K ist berücksichtigt.

L'influence de la fixation à vis de 0.30 W/m²K est prise en compte.

The 0.30 W/m²K influence of the screw fixing is taken into account.

SystemübersichtMaerkmale
Leistungseigenschaften**Sommaire du système**Caractéristiques
Caractéristiques de performance**Summary of system**Characteristics
Performance characteristics**66**

Profilsortiment**Assortiment de profilé****Range of profiles****69**

BeispieleSchnittpunkte
Anschlüsse am Bau**Exemples**Coupe de détails
Raccords au mur**Examples**Section details
Attachment to structure**72**

Alle Ausführungen dieser Dokumentation haben wir sorgfältig und nach bestem Wissen zusammengestellt. Wir können aber keine Verantwortung für die Benützung der vermittelten Vorschläge und Daten übernehmen. Wir behalten uns technische Änderungen ohne Vorankündigung vor.
Aktuelle Version auf www.jansen.com

Nous avons apporté le plus grand soin à l'élaboration de cette documentation. Cependant, nous déclinons toute responsabilité pour l'utilisation faite de nos propositions et de nos données.
Nous nous réservons le droit de procéder à des modifications techniques sans préavis.
Version actuelle sur www.jansen.com

All the information contained in this documentation is given to the best of our knowledge and ability. However, we decline all responsibility for the use made of these suggestions and data.
We reserve the right to effect technical modifications without prior warning.
Current version available at www.jansen.com

Merkmale

Caractéristiques

Characteristics

VISS Basic Semi SG-Fassaden

Façades VISS Basic Semi SG

VISS Basic Semi SG façades





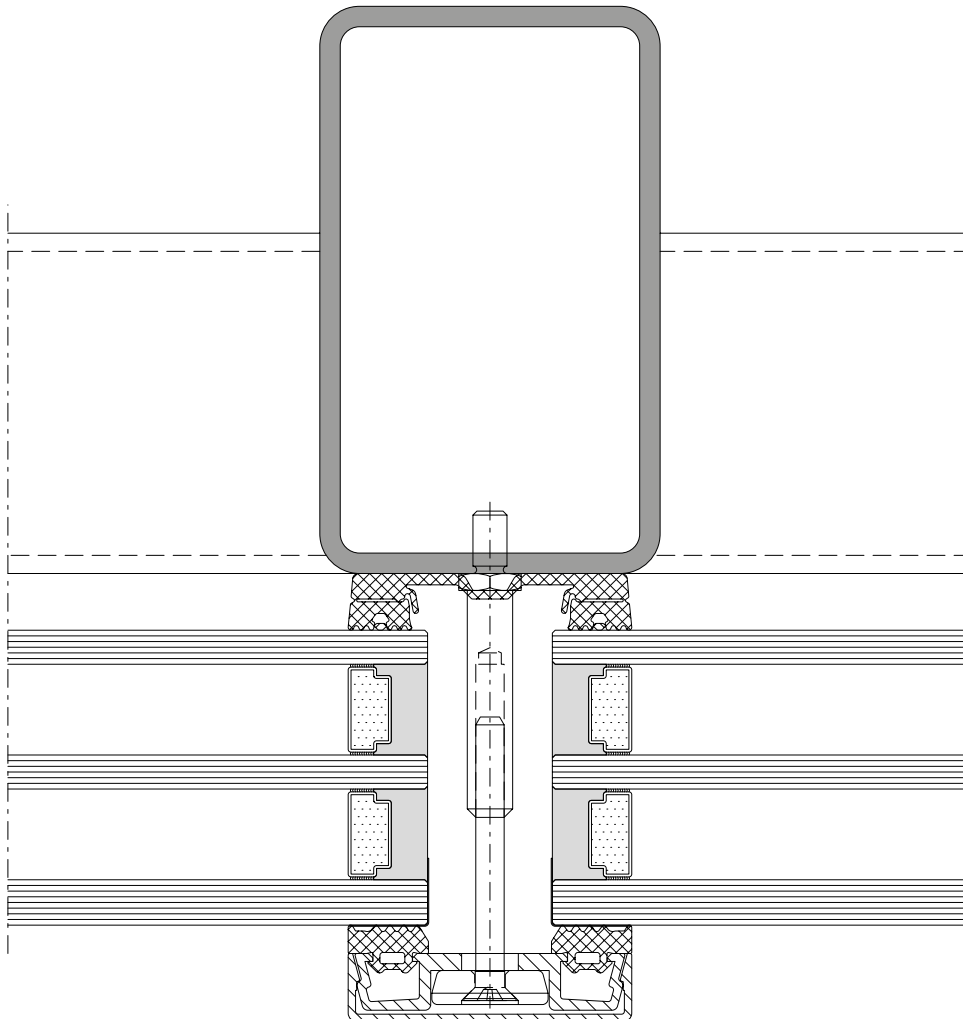

- CE-Kennzeichnung nach EN 13830
- Betonung der horizontalen oder vertikalen Linien
- Erhöht die Transparenz der Fassade
- Glasstösse mit einer Silikonfuge von nur 20 mm
- Ansichtsbreiten 50 und 60 mm
- Zweifach- und Dreifach-Isolierglas Glasstärken bis 30 - 70 mm
- Kombinierbar mit der VISS Fassade sowie VISS Basic
- Einfache Realisierung von Ganzglas-Ecklösungen
- Mechanische Fixierung der Gläser - kein Verkleben notwendig

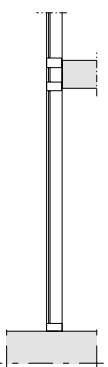
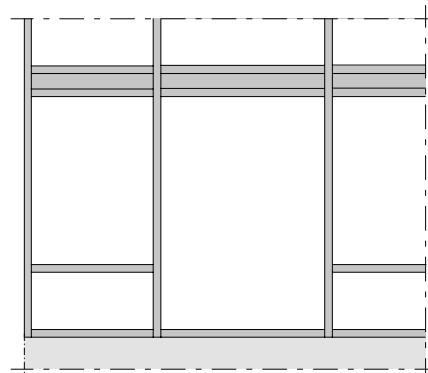
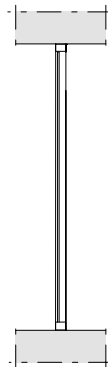
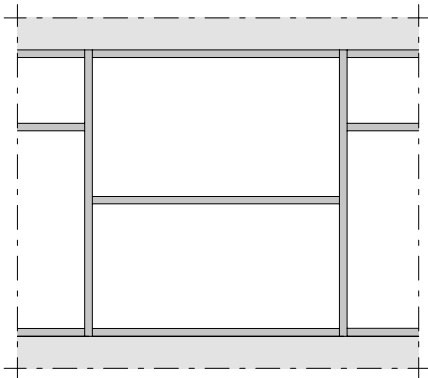
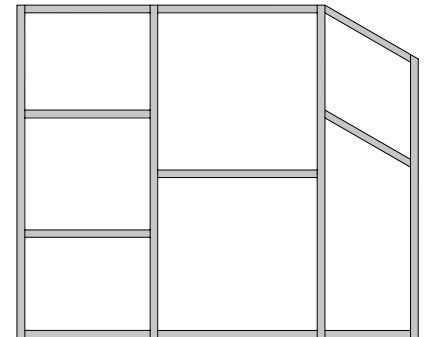
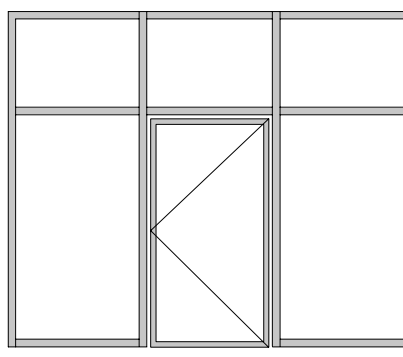
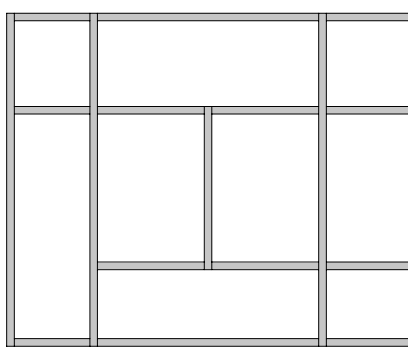
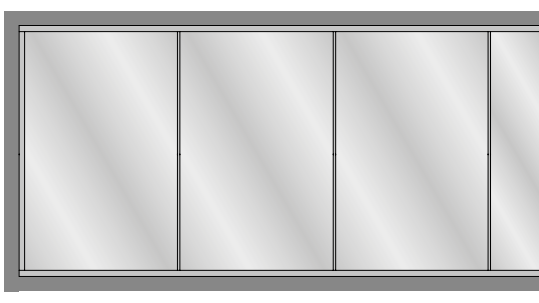
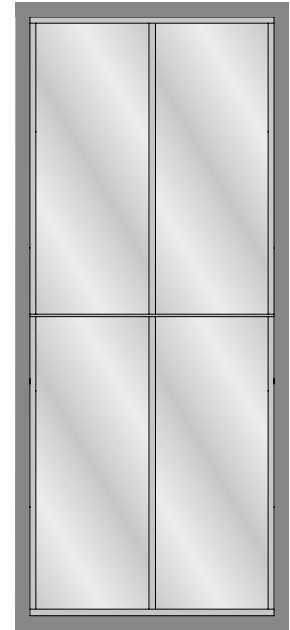
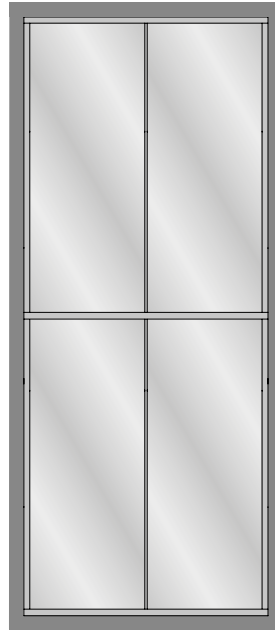
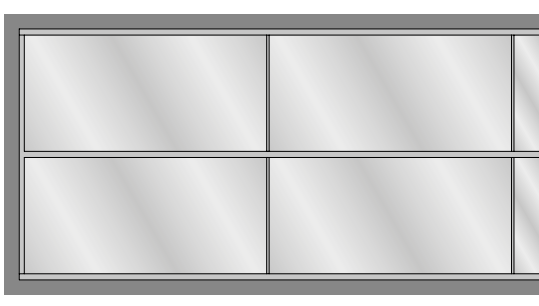
- Marquage CE selon EN 13830
- Accentuation des lignes horizontales ou verticales
- Accroît la transparence de la façade
- Étanchéité grâce à un joint silicone de seulement 20 mm
- Largeurs de face 50 et 60 mm
- Verre isolant double ou triple, épaisseurs de verre jusqu'à 30 à 70 mm
- Combinable avec les façades VISS et VISS Basic
- Réalisation simple d'angles tout verre
- Fixation mécanique des vitres - inutile de coller

- CE marking in accordance with EN 13830
- Emphasis of horizontal or vertical lines
- Increases the degree of transparency of the façade
- Glass joints with a silicone joint of just 20 mm
- Face widths of 50 and 60 mm
- Double and triple insulating glass thicknesses of up to 30 - 70 mm
- Can be combined with the VISS façade as well as VISS Basic
- Easy implementation of all-glass corner solutions
- Mechanical fixing of the glass - no bonding required





	Prüfungen (Prüfnorm) Essais (Norme d'essai) Tests (Test standard)	Klassifizierungs-Norm Norme de classification Classification standard	Werte Valeurs Values
	Schlagregendichtheit (EN 12155) Etanchéité à la pluie battante (EN 12155) Watertightness (EN 12155)	EN 12154	RE 1200
	Widerstand bei Windlast (EN 12179) Résistance à la pression du vent (EN 12179) Resistance to wind load (EN 12179)	EN 13116	Bemessungslast 2 kN/m ² Charge de calcul 2 kN/m ² Designed load 2 kN/m ²
	Luftdurchlässigkeit (EN 12153) Perméabilité à l'air (EN 12153) Air permeability (EN 12153)	EN 12152	Klasse AE Classe AE Class AE
	Wärmedurchgangskoeffizient (EN 13947) Transmission thermique (EN 13947) Thermal production (EN 13947)	EN ISO 10077-2	ab $U_f > 0.54 \text{ W/m}^2\text{K}$ dès $U_f > 0.54 \text{ W/m}^2\text{K}$ from $U_f > 0.54 \text{ W/m}^2\text{K}$
	Stossfestigkeit Résistance au chocs Impact strength	EN 14019	Klasse E5 / I5 Classe E5 / I5 Class E5 / I5
	Technische Regeln für die Verwendung von absturzsichernden Verglasungen Règlement technique pour la sécurité anti-chute des vitrages The technical regulations for protecting glazing against falling out	DIN 18008-4	Kategorie A, C2, C3 Catégorie A, C2, C3 Category A, C2, C3

Deckprofile 50 mm (Massstab 1:3)
Profils de recouvrement 50 mm (échelle 1:3)
Cover sections 50 mm (scale 1:3)

VISS Basic Semi SG-Fassaden
 Façades VISS Basic Semi SG
 VISS Basic Semi SG façades

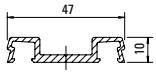

407.800

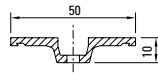

407.821



407.823

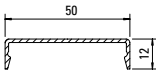

407.860

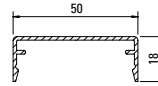

407.861

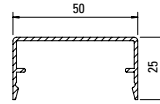

407.862

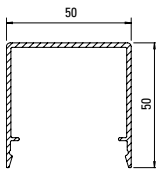

407.863

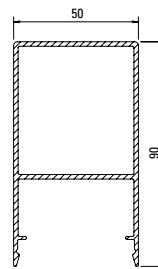

407.864

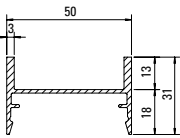

407.900

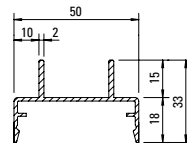

407.911

Werkstoff

Aluminium EN AW 6060 T66 roh, leicht eingeölt

Matériau

Aluminium EN AW 6060 T66 brut, légèrement huilé

Material

Aluminium EN AW 6060 T66 mill finish, slightly oiled

Profil-Nr.	G kg/m	U m ² /m	P m ² /m	L mm
407.800	0,414	0,160		6000
407.821	0,440	0,143	0,067	6000
407.823	0,076	0,043	0,019	6000
407.860	0,266	0,147	0,072	6000

Profil-Nr.	G kg/m	U m ² /m	P m ² /m	L mm
407.861	0,341	0,185	0,084	6000
407.862	0,394	0,213	0,098	6000
407.863	0,660	0,313	0,148	6000
407.864	1,344	0,360	0,228	6000
407.900	0,556	0,240	0,138	6000
407.911	0,510	0,245	0,146	6000

Deckprofile 50 mm (Masstab 1:3)**Profils de recouvrement 50 mm (échelle 1:3)****Cover sections 50 mm (scale 1:3)**

VISS Basic Semi SG-Fassaden

Façades VISS Basic Semi SG

VISS Basic Semi SG façades

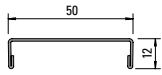
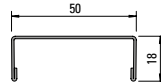
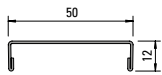
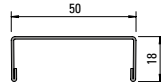
Edelstahl-Abdeckprofile**Werkstoff 1.4301 (AISI 304)**geschliffen, Korn 220/240,
mit Schutzfolie**400.860****Profilé de recouvrement acier Inox****Qualité 1.4301 (AISI 304)**meulé, degré 220/240,
avec feuille de protection**400.861****Stainless steel cover sections****Material 1.4301 (AISI 304)**polished, grain 220/240,
with protective film**Edelstahl-Abdeckprofile****Werkstoff 1.4401 (AISI 316)**geschliffen, Korn 220/240,
mit Schutzfolie**400.862****Profilé de recouvrement acier Inox****Qualité 1.4401 (AISI 316)**meulé, degré 220/240,
avec feuille de protection**400.863****Stainless steel cover sections****Material 1.4401 (AISI 316)**polished, grain 220/240,
with protective film

Profil-Nr.	G kg/m	L mm
400.860	0,644	6000
400.861	0,734	6000

Profil-Nr.	G kg/m	L mm
400.862	0,652	6000
400.863	0,744	6000

Artikelbibliothek
Bibliothèque des articles
Article library

DXF

DWG

Deckprofile 60 mm (Massstab 1:3)
Profils de recouvrement 60 mm (échelle 1:3)
Cover sections 60 mm (scale 1:3)

VISS Basic Semi SG-Fassaden
 Façades VISS Basic Semi SG
 VISS Basic Semi SG façades

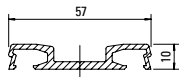

407.802

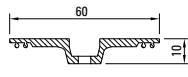

407.822



407.823

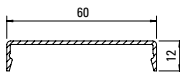

407.865

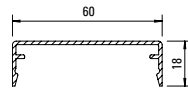

407.866

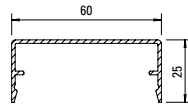

407.867

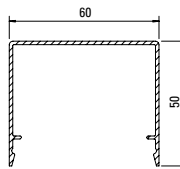

407.868

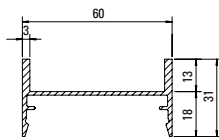

407.901

Werkstoff

Aluminium EN AW 6060 T66 roh, leicht eingeölt

Matériau

Aluminium EN AW 6060 T66 brut, légèrement huilé

Material

Aluminium EN AW 6060 T66 mill finish, slightly oiled

Profil-Nr.	G kg/m	U m ² /m	P m ² /m	L mm
407.802	0,558	0,190		6000
407.822	0,530	0,163	0,051	6000
407.823	0,076	0,043	0,019	6000
407.865	0,304	0,167	0,082	6000
407.866	0,379	0,205	0,094	6000
407.867	0,432	0,223	0,108	6000
407.868	0,750	0,330	0,160	6000
407.901	0,590	0,255	0,148	6000

Schnittpunkte im Massstab 1:2
Coupe de détails à l'échelle 1:2
Section details on scale 1:2

VISS Basic Semi SG-Fassaden
Façades VISS Basic Semi SG
VISS Basic Semi SG façades

VISS Basic Semi SG
Ansichtsbreite 50 mm
Schraubbolzen

VISS Basic Semi SG
Largeur de face 50 mm
Goujon à visser

VISS Basic Semi SG
Width 50 mm
Screw bolt

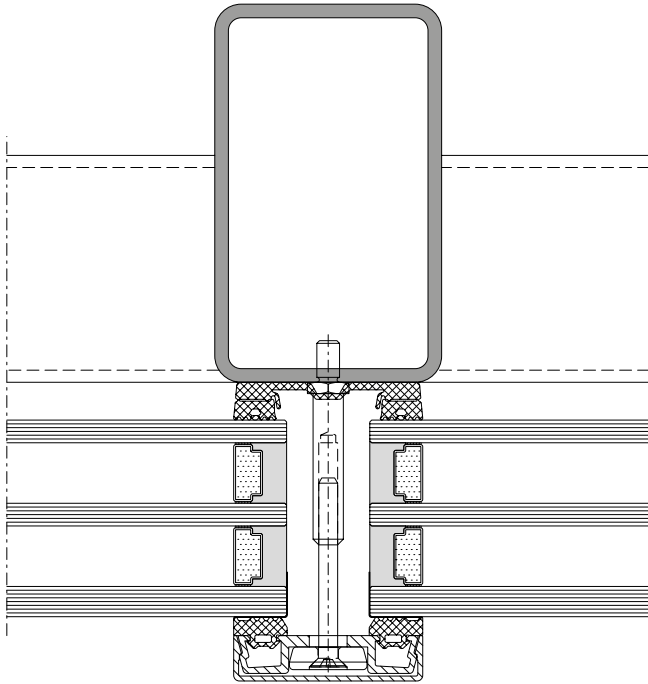

DXF DWG D-534-C-004

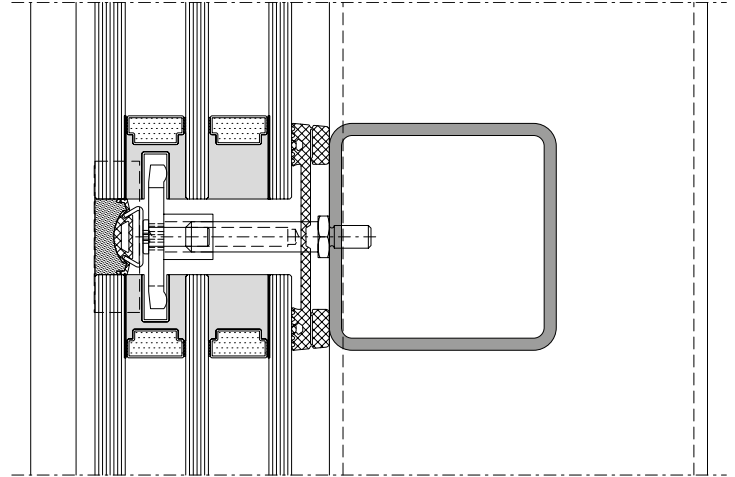

DXF DWG D-534-C-005

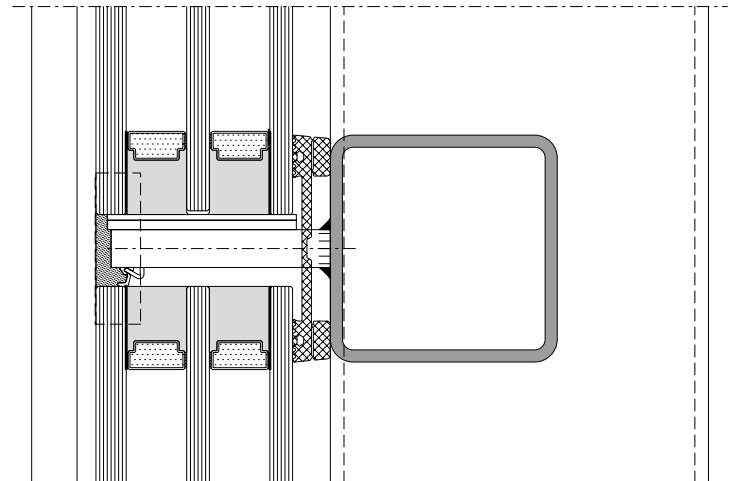

DXF DWG D-534-C-006

Schnittpunkte im Massstab 1:2
Coupe de détails à l'échelle 1:2
Section details on scale 1:2

VISS Basic Semi SG-Fassaden
Façades VISS Basic Semi SG
VISS Basic Semi SG façades

VISS Basic Semi SG
Ansichtsbreite 50 mm
Schraubbolzen

VISS Basic Semi SG
Largeur de face 50 mm
Goujon à visser

VISS Basic Semi SG
Width 50 mm
Screw bolt

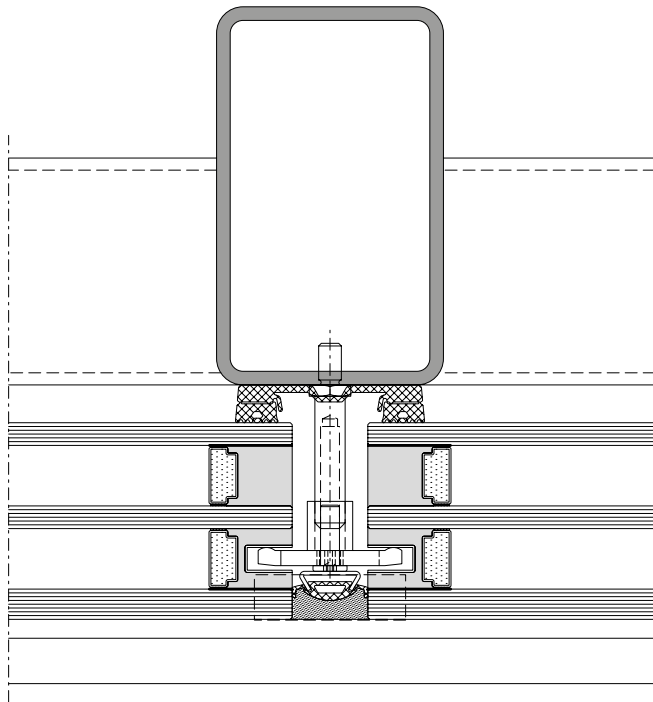

DXF DWG D-534-C-010

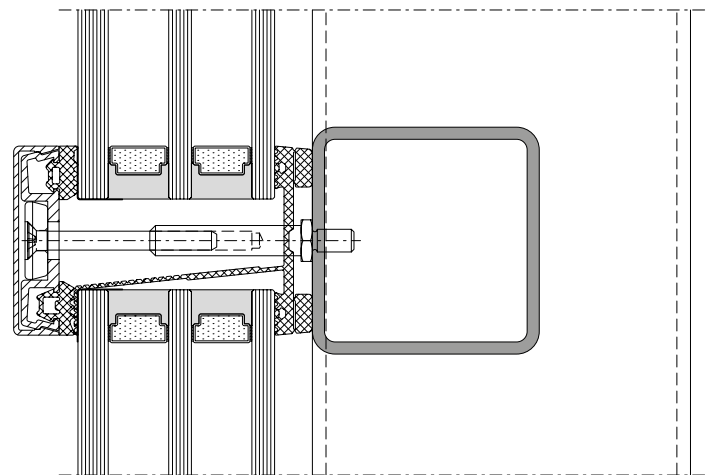

DXF DWG D-534-C-011

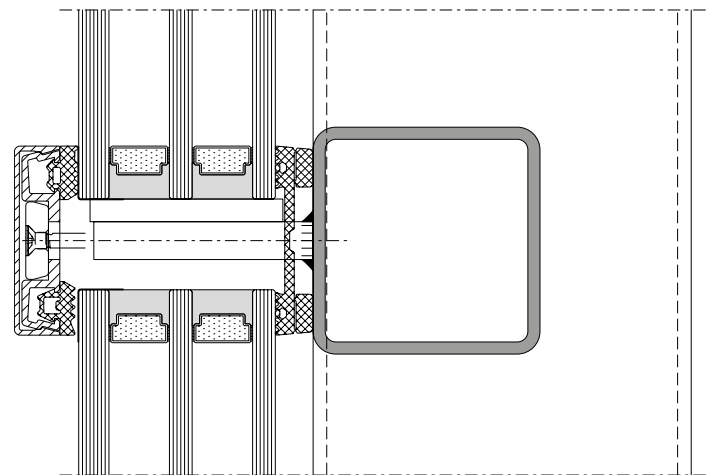

DXF DWG D-534-C-012

Schnittpunkte im Massstab 1:2
Coupe de détails à l'échelle 1:2
Section details on scale 1:2

VISS Basic Semi SG-Fassaden
Façades VISS Basic Semi SG
VISS Basic Semi SG façades

VISS Basic Semi SG
Ansichtsbreite 50 mm
Schweissbolzen

VISS Basic Semi SG
Largeur de face 50 mm
Goujon à souder

VISS Basic Semi SG
Width 50 mm
Welding stud

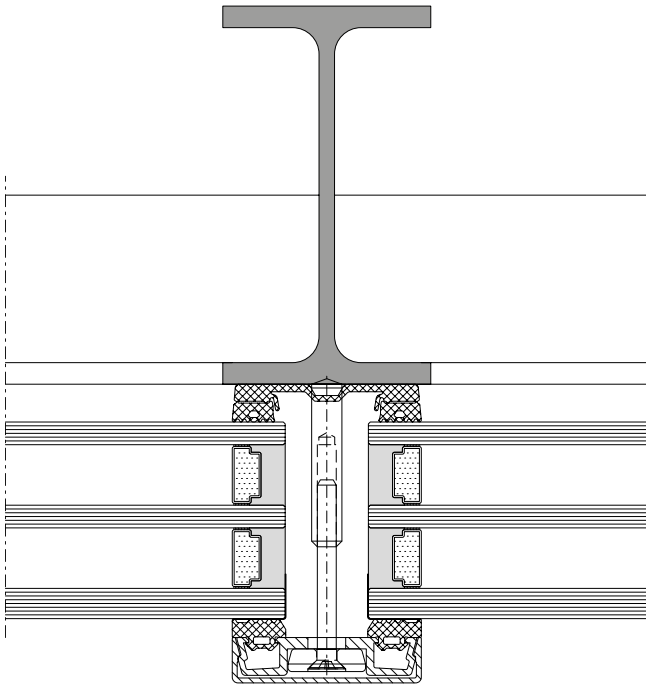

DXF DWG D-535-C-004

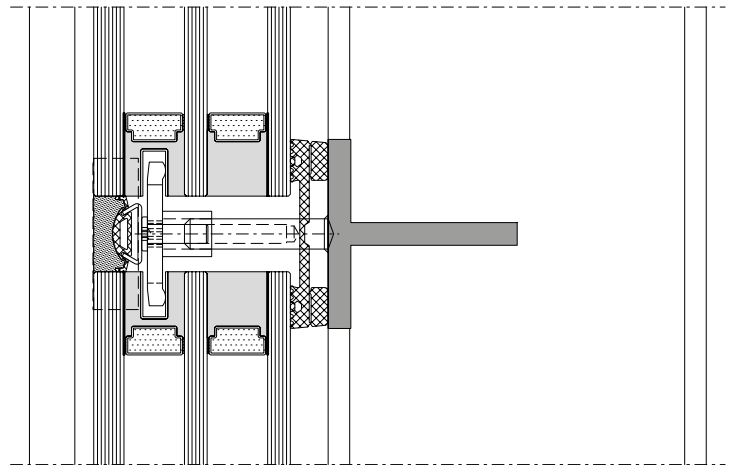

DXF DWG D-535-C-005

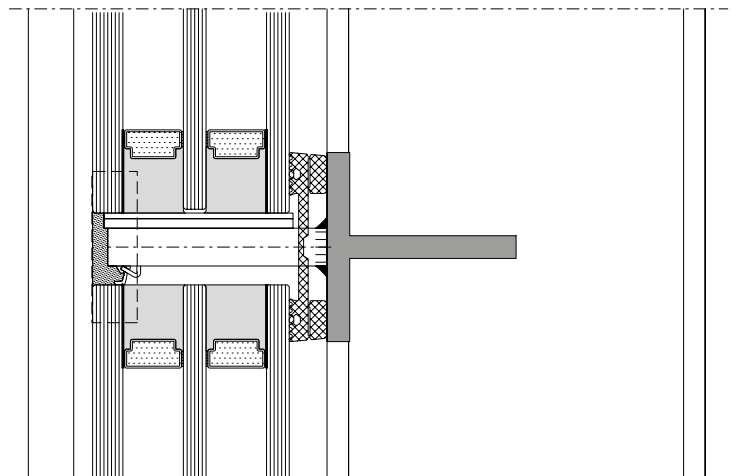

DXF DWG D-535-C-006

Schnittpunkte im Massstab 1:2
Coupe de détails à l'échelle 1:2
Section details on scale 1:2

VISS Basic Semi SG-Fassaden
Façades VISS Basic Semi SG
VISS Basic Semi SG façades

VISS Basic Semi SG
Ansichtsbreite 50 mm
Schweissbolzen

VISS Basic Semi SG
Largeur de face 50 mm
Goujon à souder

VISS Basic Semi SG
Width 50 mm
Welding stud

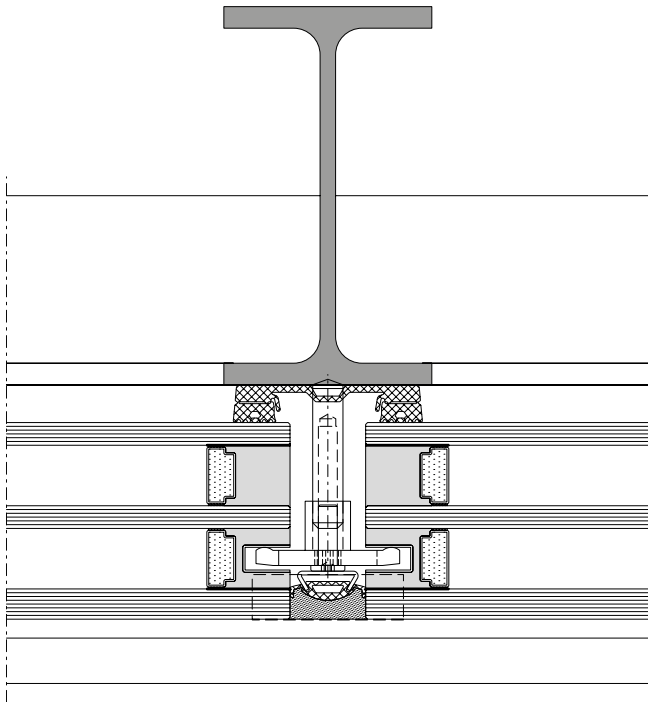

DXF DWG D-535-C-010

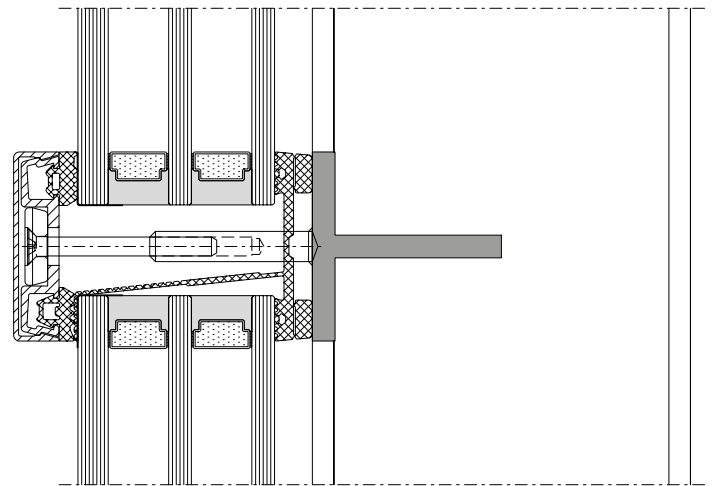

DXF DWG D-535-C-011

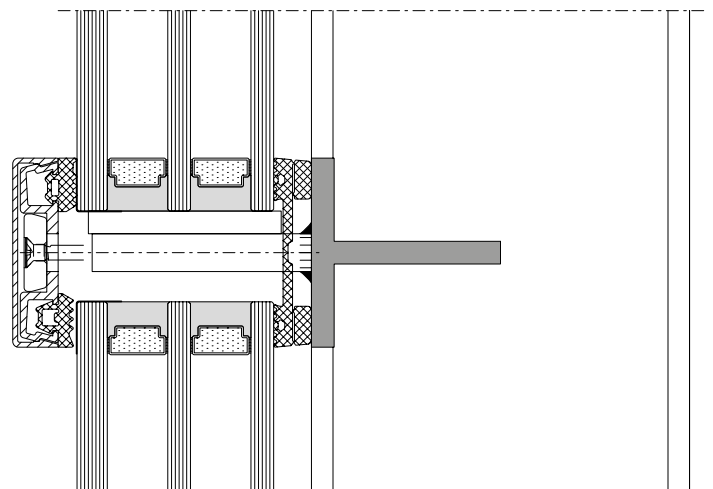

DXF DWG D-535-C-012

